

REV.	DESCRIPTION	DRAWN	DATE
1	Initial Release	FROS	2014/11/24
2	Add dimensions	FROS	2015/07/01

SPECIFICATION:

1. ELECTRICAL
 - 1.1 Current Rating: 0.5A DC/AC
 - 1.2 Voltage Rating: 10V DC/AC
 - 1.3 Contact Resistance:
 - P1~P8: 100mΩ Max.
 - CD: 140mΩ Max.**
 - 1.4 Insulation Resistance: 1000 MΩ Min.
 - 1.5 Dielectric Withstanding Voltage: 500VAC for 1 minute
2. MECHANICAL
 - 2.1 Durability: 5,000 Cycle
 - 2.2 Insertion Force: 10N Max.
 - 2.3 Extraction Force: 0.5N Min.
3. ENVIRONMENTAL
 - 3.1 Operating temperature range: - 25°C ~ + 85°C
 - 3.2 Storage temperature range: - 25°C ~ + 85°C

NO.	PART NAME	DESCRIPTION
6	SLIDER	LCP E130i, UL94V-0, Black
5	SHELL	SUS304CSP-3/4H, 0.15t, 50u" nickel plated
4	CRANK	SUS304, 0.35d
3	SPRING	SWP-B, 0.20d, 80u" copper coating over 65u" nickel plated
2	CONTACT	C5210R-H, 0.12t, 5u" gold on contact area 1u" gold on tail area, under plated: 50u" nickel
1	HOUSING	LCP E130i, UL94V-0, Black

UNLESS OTHERWISE SPECIFIED TOLERANCE				 WWW.ATTEND.COM.TW	
UNIT:	DECIMAL	LINEAR	ANGLES		
mm	X.	±0.50	±5°		
	X.X	±0.25	±3°		
	X.XX	±0.12	±1°		

DRAWN	Fros	2014/11/24	DRAWN NAME:		
CHECKED	Ron	2014/11/24	Micro SIM Card Socket push-push type		
APPROVED	Albert	2014/11/24	PRODUCT NO.	115Q-BCA0	
SCALE	3.5/1	SHEET	1/4	SIZE	A4
			FILE NAME	115Q-BCA0_B_2	

REV.	DESCRIPTION	DRAWN	DATE
	SEE SHEET 1		

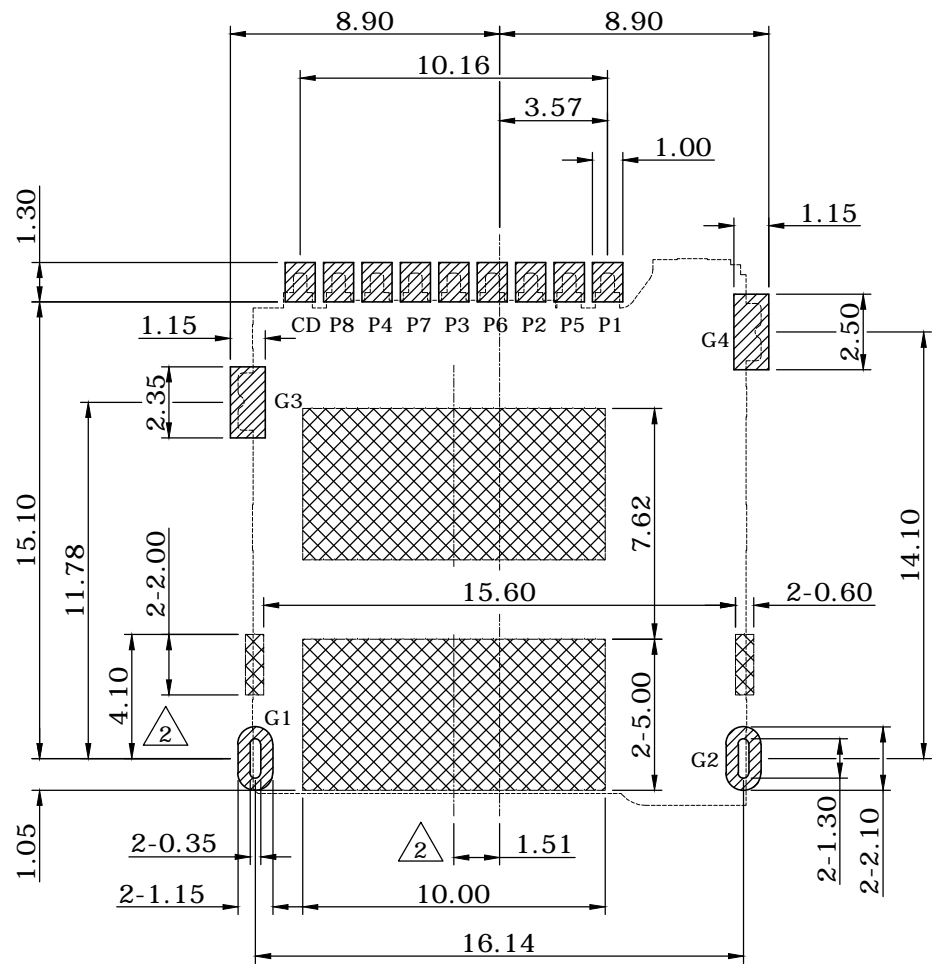

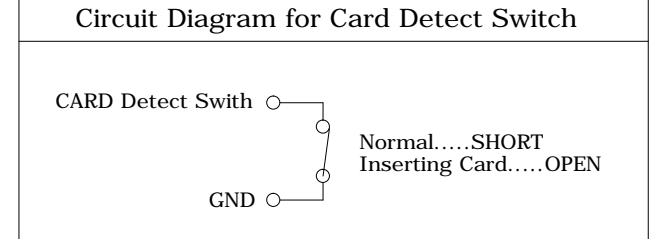

Connector terminal NO.	Pin Name
PIN 1	VCC:PWR signal and GND
PIN 2	RST:Reset singal
PIN 3	CLK:Clocking singal
PIN 4	Reserved
PIN 5	GND:PWR singal and GND
PIN 6	VPP:programming Voltage
PIN 7	I/O:serial date input/output
PIN 8	Reserved

G1~G4	GND
CD	CARD DETECTOR



 There should not be any circuits in layout area of the products.

Recommended PCB layout
General Tolerance±0.05

UNLESS OTHERWISE SPECIFIED TOLERANCE				 WWW.ATTEND.COM.TW	
UNIT:	DECIMAL	LINEAR	ANGLES		
mm	X.	±0.50	±5°		
	X.X	±0.25	±3°		
	X.XX	±0.12	±1°		
DRAWN	Fros	2014/11/24	DRAWN NAME: Micro SIM Card Socket push-push type		
CHECKED	Ron	2014/11/24			
APPROVED	Albert	2014/11/24	PRODUCT NO.	115Q-BCA0	
	SCALE 4/1	SHEET 2/4	SIZE A4	FILE NAME	115Q-BCA0_B_2

REV.	DESCRIPTION	DRAWN	DATE
	SEE SHEET 1		

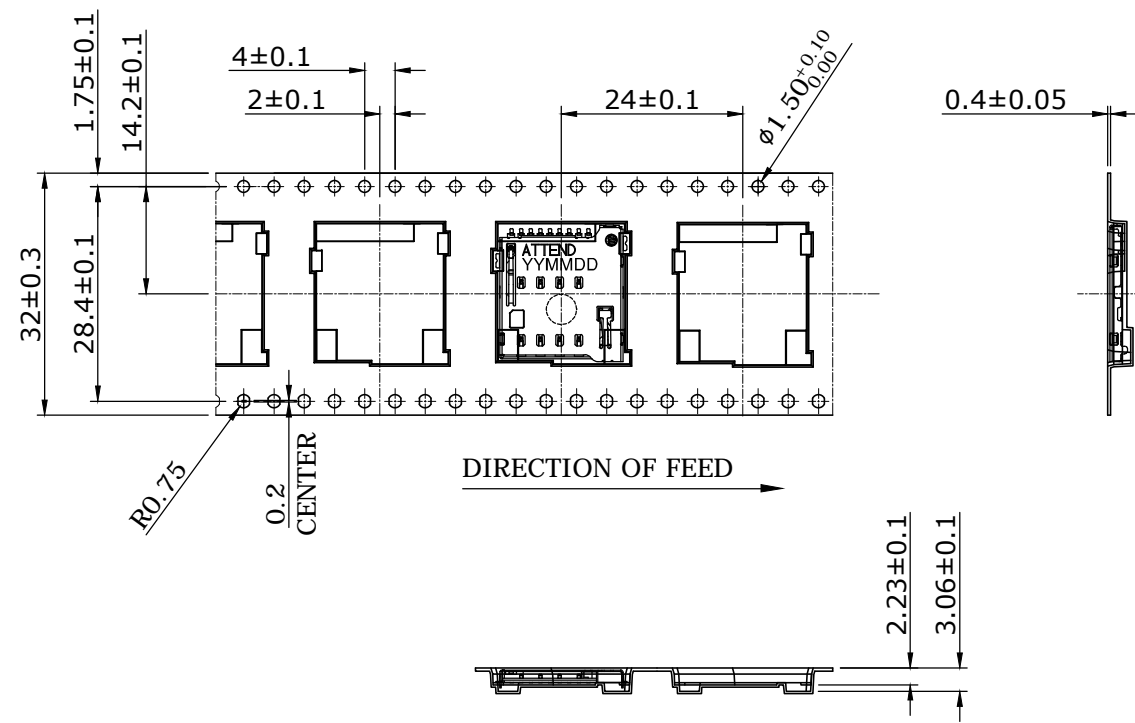
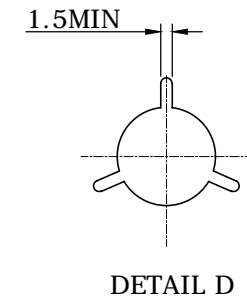
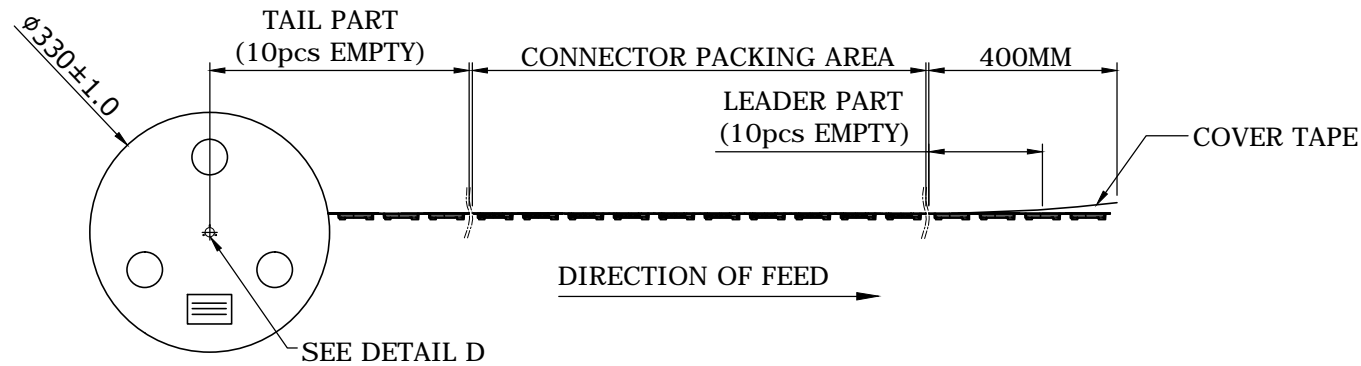

PACKAGING SPECIFICATION:

1. MATERIAL
 - 1.1 Embossed Carrier Tape: PS Black
 - 1.2 Top Cover Tape: PE
20-80g (Peel Speed 300mm/Minute)
 - 1.3 Taping Reel: Plastic Paper
2. PACKING
 - 2.1 Quantity:
800 Piece/Reel
6 Reel/Inner Carton
4800 Piece/Outer Carton
 - 2.2 Net Weight: 0.67g
 - 2.3 Gross Weight: 6.65Kg/Carton

UNLESS OTHERWISE SPECIFIED TOLERANCE						
UNIT:	DECIMAL	LINEAR	ANGLES			
mm	X.	±0.50	±5°	WWW.ATTEND.COM.TW		
	X.X	±0.25	±3°			
	X.XX	±0.12	±1°			
DRAWN	Fros	2014/11/24	DRAWN NAME: Micro SIM Card Socket push-push type			
CHECKED	Ron	2014/11/24	PRODUCT NO. 115Q-BCA0			
APPROVED	Albert	2014/11/24	SCALE	SHEET	SIZE	FILE NAME
		1/1	3/4	A4	115Q-BCA0_B_2	

REV.	DESCRIPTION	DRAWN	DATE
	SEE SHEET 1		

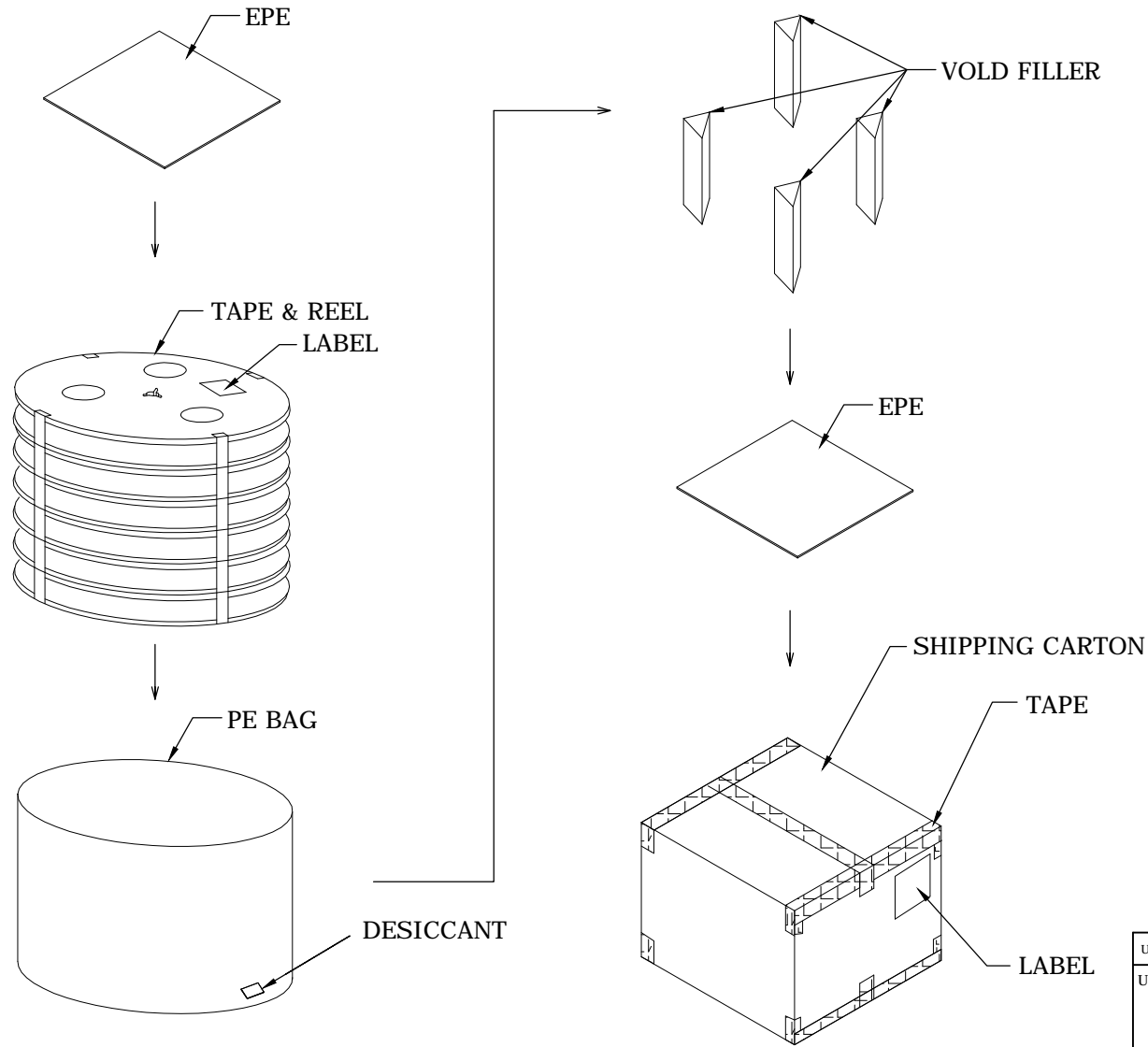

UNLESS OTHERWISE SPECIFIED TOLERANCE			
UNIT:	DECIMAL	LINEAR	ANGLES
mm	X.	±0.50	±5°
	X.X	±0.25	±3°
	X.XX	±0.12	±1°



WWW.ATTEND.COM.TW

DRAWN	Fros	2014/11/24	DRAWN NAME:		
CHECKED	Ron	2014/11/24	Micro SIM Card Socket push-push type		
APPROVED	Albert	2014/11/24	PRODUCT NO.	115Q-BCA0	
SCALE N/A		SHEET 4/4	SIZE A4	FILE NAME	115Q-BCA0_B_2