

REV.	DESCRIPTION	DRAWN	DATE
1	INITIAL RELEASE	FROS	2019/04/15

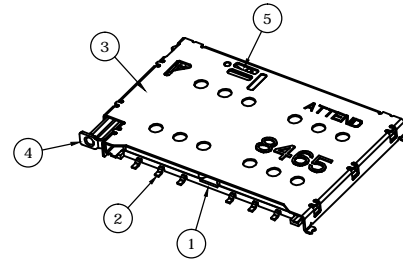

SCALE 1.5/1

SPECIFICATION:

1. ELECTRICAL
 - 1.1 Current Rating: 0.5A max.
 - 1.2 Voltage Rating: 10VAC/DC
 - 1.3 Contact Resistance: 50mΩ
 - 1.4 Insulation Resistance: 1000MΩ
 - 1.5 Dielectric Withstanding Voltage: 500VAC
2. MECHANICAL
 - 2.1 Durability: 2,000 Cycles
 - 2.2 Tray Insertion Force: 10N max.
 - 2.3 Tray Extraction Force: 3N min.
 - 2.4 Contact Normal Force: 20gf min. per pin
3. ENVIRONMENTAL
 - 3.1 Operating temperature range: -40°C~+105°C
 - 3.2 Storage temperature range: -40°C~+105°C
4. SOLDER ABILITY
 - 4.1 Recommended IR-Reflow Temperature: 260°C

Date code: YWWD
 Y= year 0~9
 WW=Week 1~52
 D= 1~7

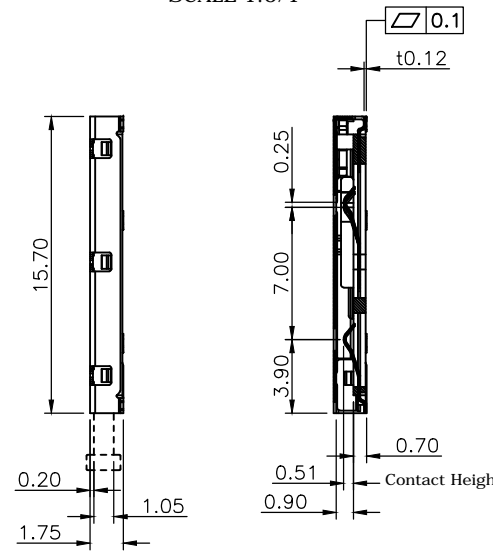

Section A-A

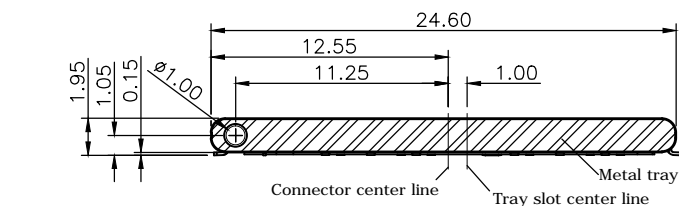
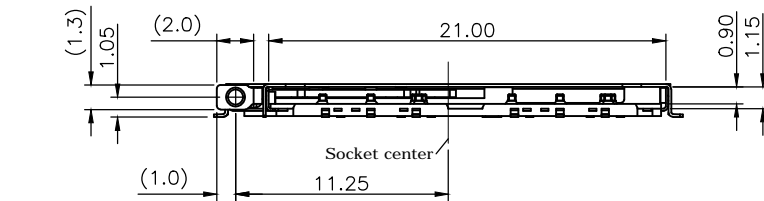
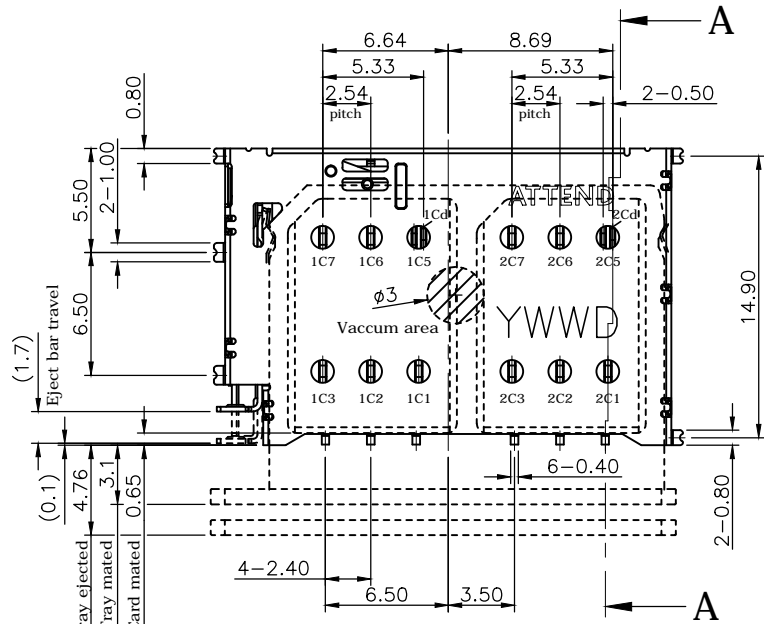
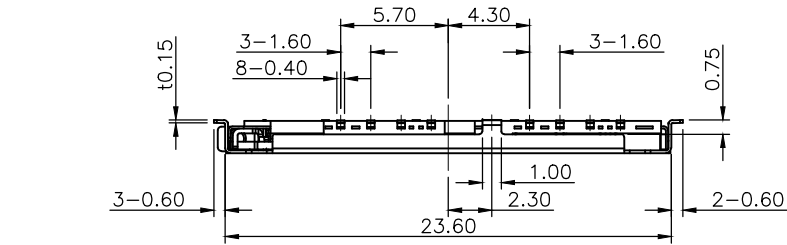

5	CAM	Stainless Steel 0.4t
4	BAR	Stainless Steel 0.25t
3	SHELL	Stainless Steel 0.15t, solder area: Gold flash, under plating 12u" Nickel
2	CONTACT	Copper alloy 0.12t, contact area: 30u" Gold plating solder area: Gold flash, under plating 50u" Nickel
1	HOUSING	LCP, UL94V-0, black

NO.	PART NAME	DESCRIPTION			
UNLESS OTHERWISE SPECIFIED TOLERANCE					
UNIT:	DECIMAL	LINEAR	ANGLES		
	mm	X. ±0.50	±5°		
		X.X ±0.25	±3°		
		X.XX ±0.12	±1°		
DRAWN	Fros	2018/10/23	DRAWN NAME: Nano SIM Socket, Dual Card Tray Eject Type, 30u"		
CHECKED	Tim	2018/10/23			
APPROVED	Ken	2018/10/23			
SCALE		SHEET	SIZE	PRODUCT NO.	115S-BS00
2.5/1		1/2	A4	FILE NAME	115S-BS00_B_1



www.attend.com.tw

REV.	DESCRIPTION	DRAWN	DATE
	see sheet one		

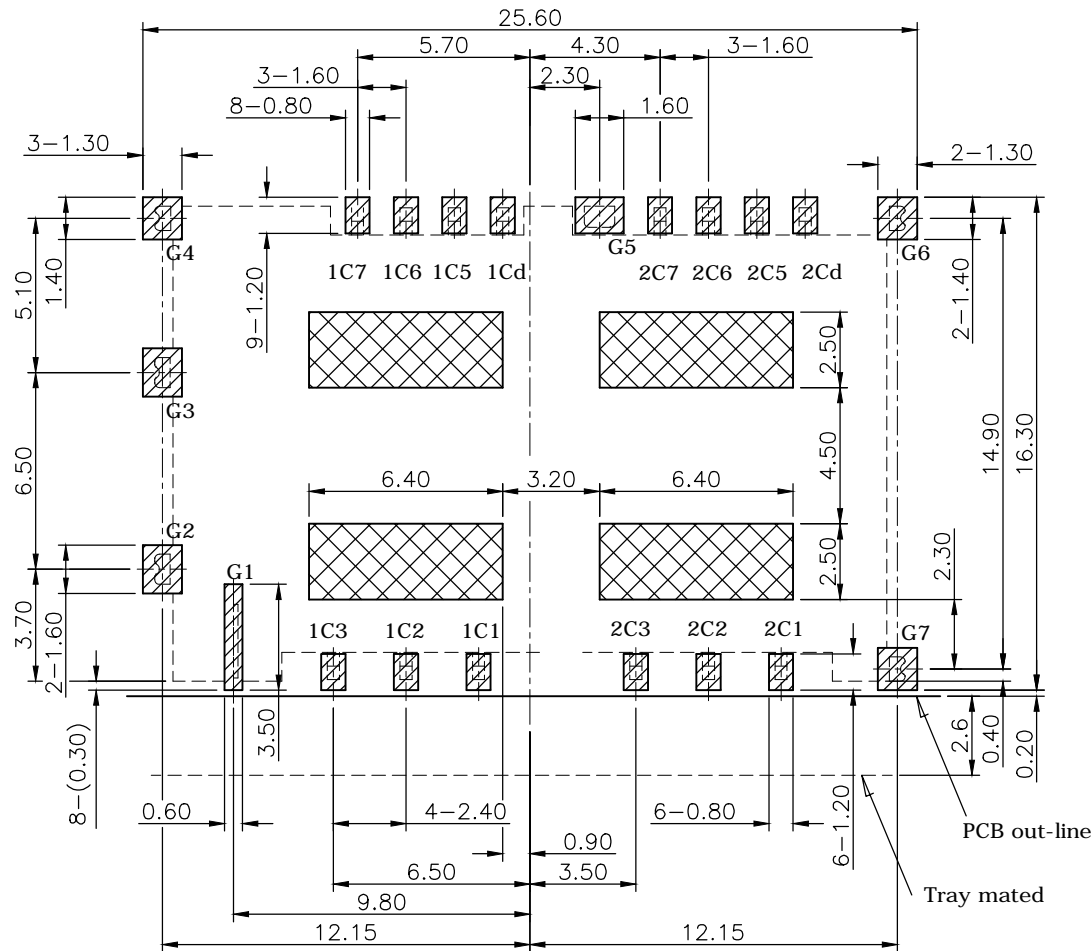

- Socket
- Solder PAD
- NO pattern area

Pin assignment

Pin no.		Description
1C1	2C1	Vcc
1C2	2C2	RST
1C3	2C3	CLK
1Cd	2Cd	Detect
1C5	2C5	GND
1C6	2C6	Vpp
1C7	2C7	I/O

RECOMMENDED LAYOUT (TOP VIEW)
GENERAL TOLERANCE: ±0.05mm

UNLESS OTHERWISE SPECIFIED TOLERANCE

UNIT:	DECIMAL	LINEAR	ANGLES
	X.	±0.50	±5°
	X.X	±0.25	±3°
	X.XX	±0.12	±1°



www.attend.com.tw

DRAWN	Fros	2018/10/23	DRAWN NAME:	Nano SIM Socket, Dual Card Tray Eject Type, 30u"
CHECKED	Tim	2018/10/23	PRODUCT NO.	115S-BS00
APPROVED	Ken	2018/10/23	FILE NAME	115S-BS00_B_1
	SCALE	SHEET	SIZE	
	4/1	2/2	A4	

REV.	DESCRIPTION	DRAWN	DATE
	see sheet one		

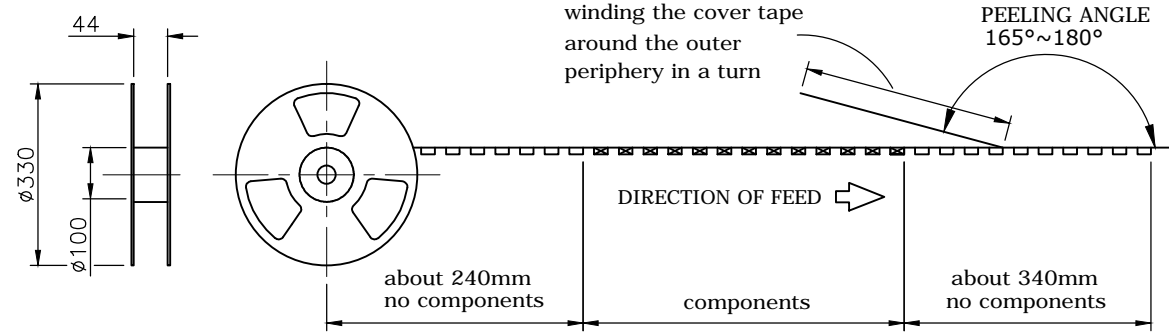

PACKAGING SPECIFICATION:

1. MATERIAL
 - 1.1 Embossed Carrier Tape: PS Black
 - 1.2 Top Cover Tape: PET
20-80g (Peel Speed 300mm/Minute)
 - 1.3 Taping Reel: Plastic
2. PACKING
 - 2.1 Quantity:
 - 1,200 PCS/REEL
 - 6 REEL/Carton
 - 7,200 PCS/Carton

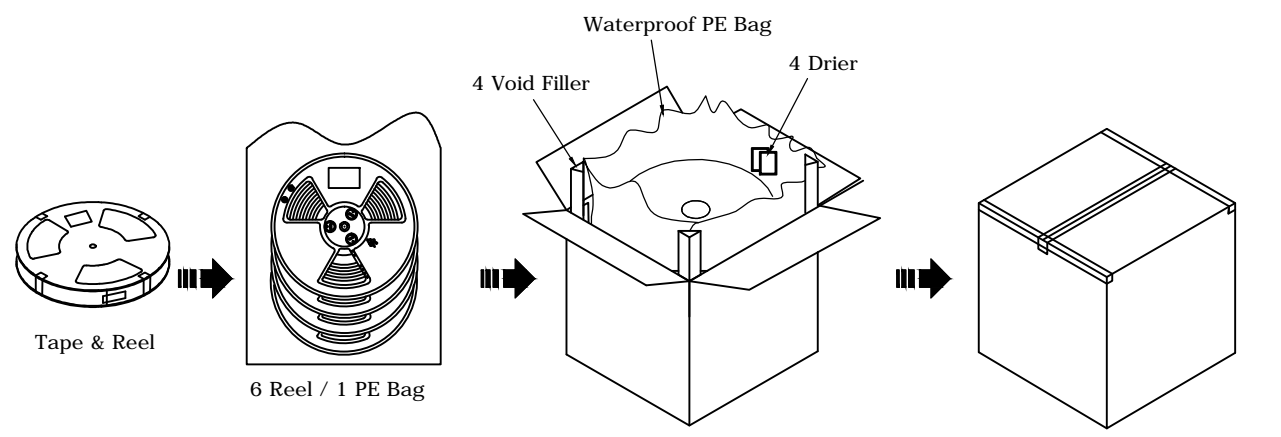
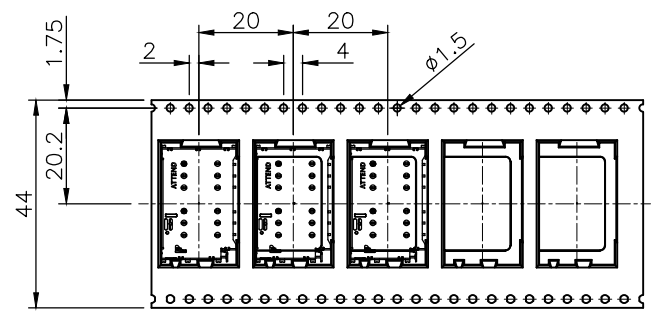

UNLESS OTHERWISE SPECIFIED TOLERANCE				 www.attend.com.tw
UNIT:	DECIMAL	LINEAR	ANGLES	
mm	X.	±0.50	±5°	
	X.X	±0.25	±3°	
	X.XX	±0.12	±1°	
DRAWN	Fros	2018/10/23	DRAWN NAME:	
CHECKED	Tim	2018/10/23	Nano SIM Socket, Dual Card Tray Eject Type, 30u"	
APPROVED	Ken	2018/10/23	PRODUCT NO. 115S-BS00	
SCALE	N/A	SHEET 1/1	SIZE A4	FILE NAME 115S-BS00_D_1

Carton L*W*H=350*350*320

REV.	DESCRIPTION	DRAWN	DATE
1	INITIAL RELEASE	FROS	2021/04/01

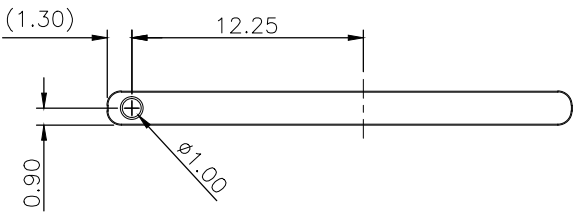
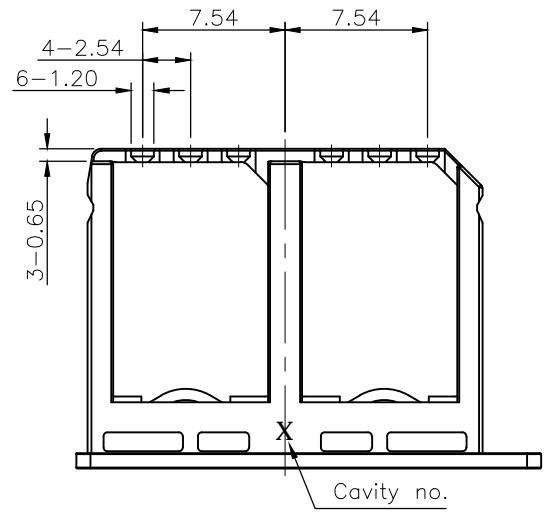
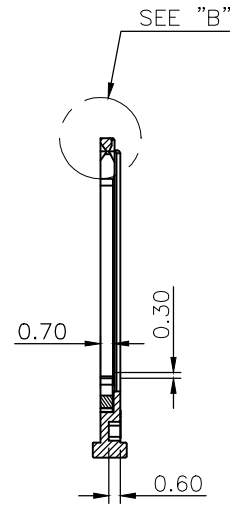
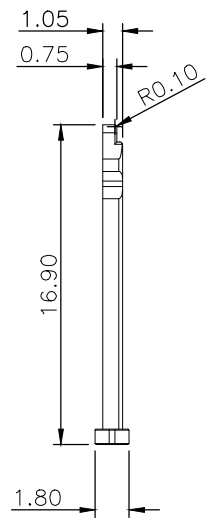
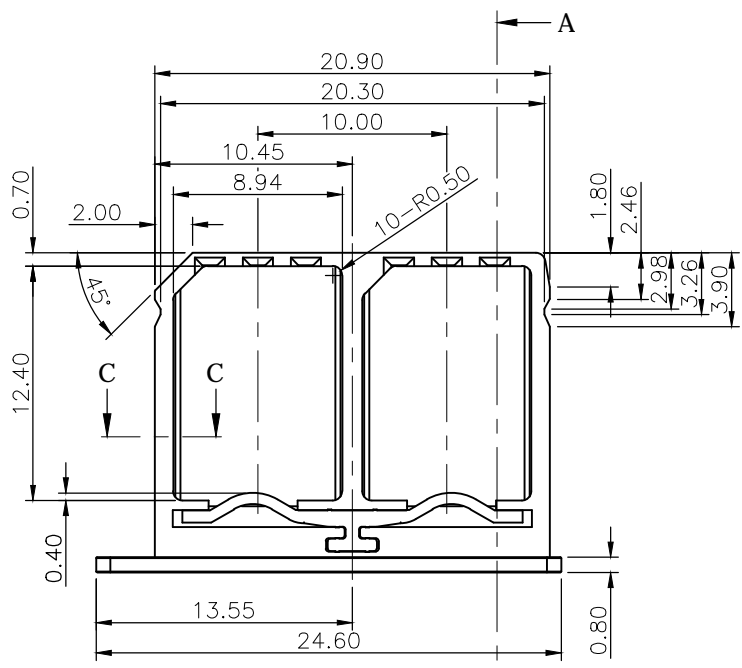
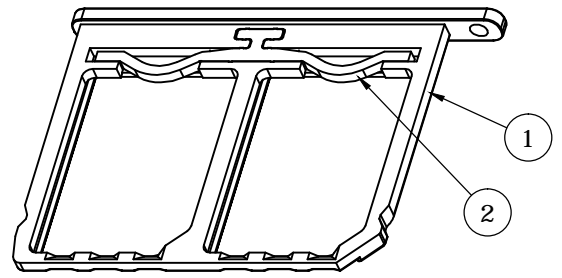
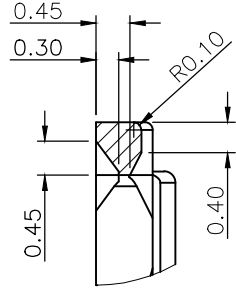
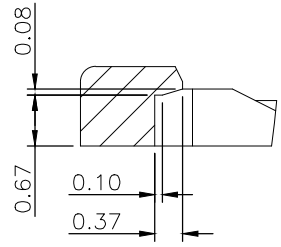
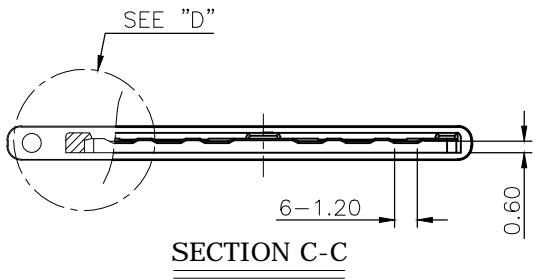

2	Card Clip	Nylon	
1	Tray	Stainless steel	
NO.	PART NAME	DESCRIPTION	
UNLESS OTHERWISE SPECIFIED TOLERANCE			
UNIT:	DECIMAL	LINEAR	ANGLES
	mm	X.X ±0.50	±5°
		X.X ±0.25	±3°
	X.XX ±0.12	±1°	
DRAWN		Fros	2021/04/01
CHECKED		Tim	2021/04/01
APPROVED		Ken	2021/04/01
SCALE		2.5	SHEET 1/1
SIZE		A4	
DRAWN NAME:		Nano SIM Tray, Dual Card, SUS316, Natural color, 16.9mm, Reel, with card clip	
PRODUCT NO.		115S-BT02	
FILE NAME		115S-BT02_B_1	



www.attend.com.tw

REV.	DESCRIPTION	DRAWN	DATE
	see sheet one		

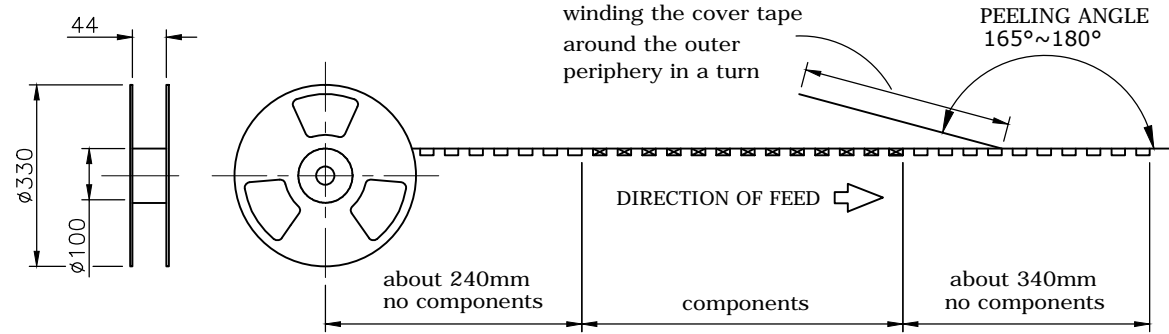

PACKAGING SPECIFICATION:

1. MATERIAL
 - 1.1 Embossed Carrier Tape: PS Black
 - 1.2 Top Cover Tape: PET
20-80g (Peel Speed 300mm/Minute)
 - 1.3 Taping Reel: Plastic
2. PACKING
 - 2.1 Quantity:
 - 1,200 PCS/REEL
 - 6 REEL/Carton
 - 7,200 PCS/Carton

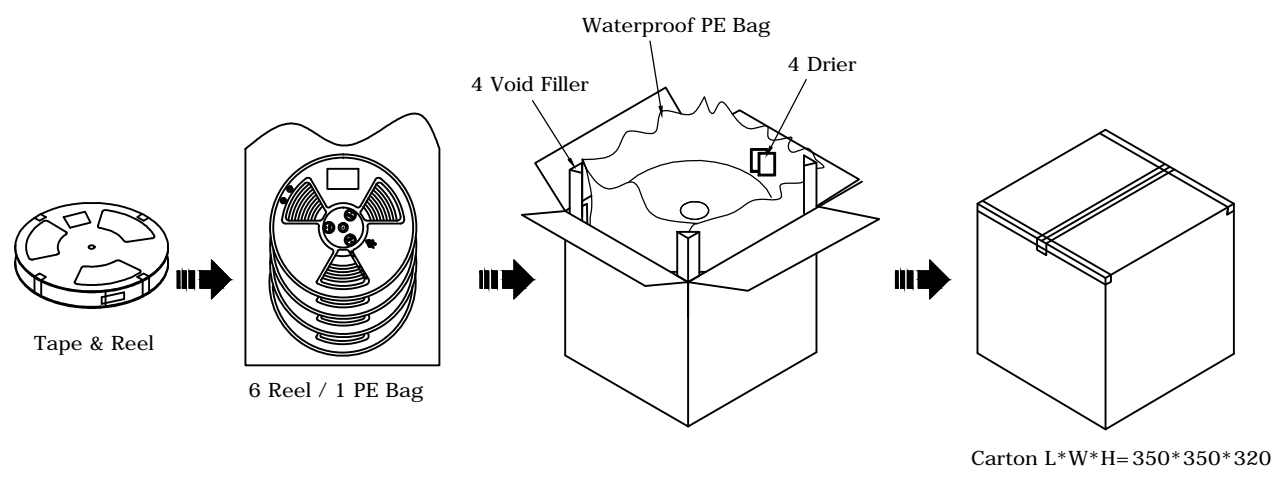
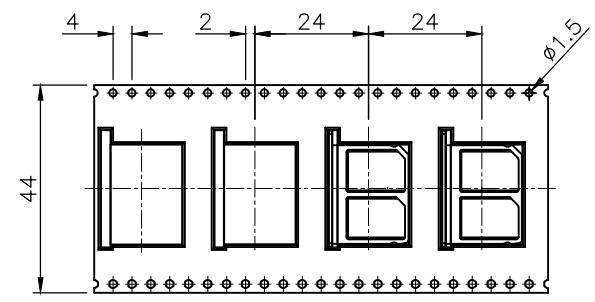

UNLESS OTHERWISE SPECIFIED TOLERANCE				 www.attend.com.tw
UNIT:	DECIMAL	LINEAR	ANGLES	
mm	X.	±0.50	±5°	
	X.X	±0.25	±3°	
	X.XX	±0.12	±1°	
DRAWN	Tim	2018/12/10	DRAWN NAME:	
CHECKED	Fros	2018/12/10	Nano SIM Tray, Dual Card, SUS316 Natural color, 16.9mm, Reel	
APPROVED	Ken	2018/12/10	PRODUCT NO. 115S-BT00	
SCALE	N/A	SHEET 1/1	SIZE A4	FILE NAME 115S-BT00_D_1