

REV.	DESCRIPTION	DRAWN	DATE
1	INITIAL RELEASE	FROS	2021/11/19

DATE CODE: YWWD
 Y= YEAR (2020)
 WW= WEEK (01-52)
 D= DAY (1-7)

SPECIFICATION:

1. ELECTRICAL
 - 1.1 Current Rating: 0.5A per pin
 - 1.2 Voltage Rating: 10V DC
 - 1.3 Contact Resistance: 100mΩ Max.
 - 1.4 Insulation Resistance: 1000MΩ
 - 1.5 Dielectric Withstanding Voltage: 500VAC
2. MECHANICAL
 - 2.1 Durability: 5,000 cycles
 - 2.2 Contact Normal Force: 0.5N Max. per pin
 - 2.3 Tray Lock Force: 3N Min.
3. ENVIRONMENTAL
 - 3.1 Operating temperature range: -40°C~+85°C
 - 3.2 Storage temperature range: -40°C~+85°C
4. SOLDER ABILITY
 - 4.1 Recommended IR-Reflow Temperature: 260°C

This part (115U-B100) is a connector only, it should be used together with Nano SIM Tray (115U-T003)

*	115U-T003	Card tray with Nano SIM on double side, used for 115U-B100, PC+ABS, Black, Reel
---	-----------	---

6	CRANK	Stainless Steel
5	SPRING	SWP-B, Nickel plating
4	SLIDER	LCP, UL94V-0, Black
3	SHELL	Stainless Steel, Nickel plating
	SIM2	Contact: Phosphor Bronze, Gold plating over Nickel
2	MOLDING	Insulator: LCP, UL94V-0, Black
	SIM1	Contact: Phosphor Bronze, Gold plating over Nickel
1	MOLDING	Insulator: LCP, UL94V-0, Black

NO.	PART NAME	DESCRIPTION	
UNLESS OTHERWISE SPECIFIED TOLERANCE			
UNIT:	DECIMAL	LINEAR	ANGLES
	X.	±0.50	±5°
	X.X	±0.25	±3°
	X.XX	±0.12	±1°
DRAWN: Fros 2021/07/23			
CHECKED: Tim 2021/07/23			
APPROVED: Ken 2021/07/23			
SCALE: 2/1		SHEET: 1/4	SIZE: A4
DRAWN NAME: Dual Nano SIM Socket, Tray-Push Push, Lock w/Switch, G/F, Reel		PRODUCT NO. 115U-B100	
FILE NAME: 115U-B100_B_1			

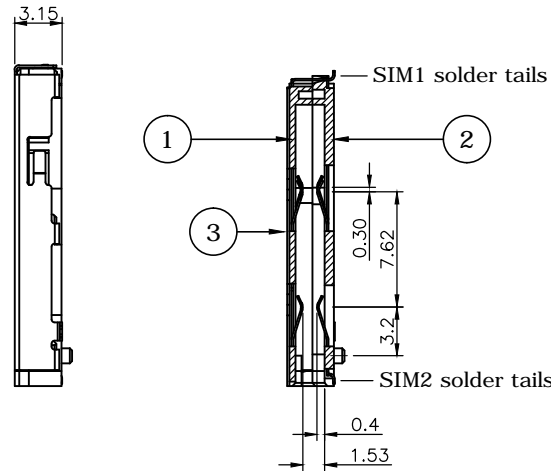
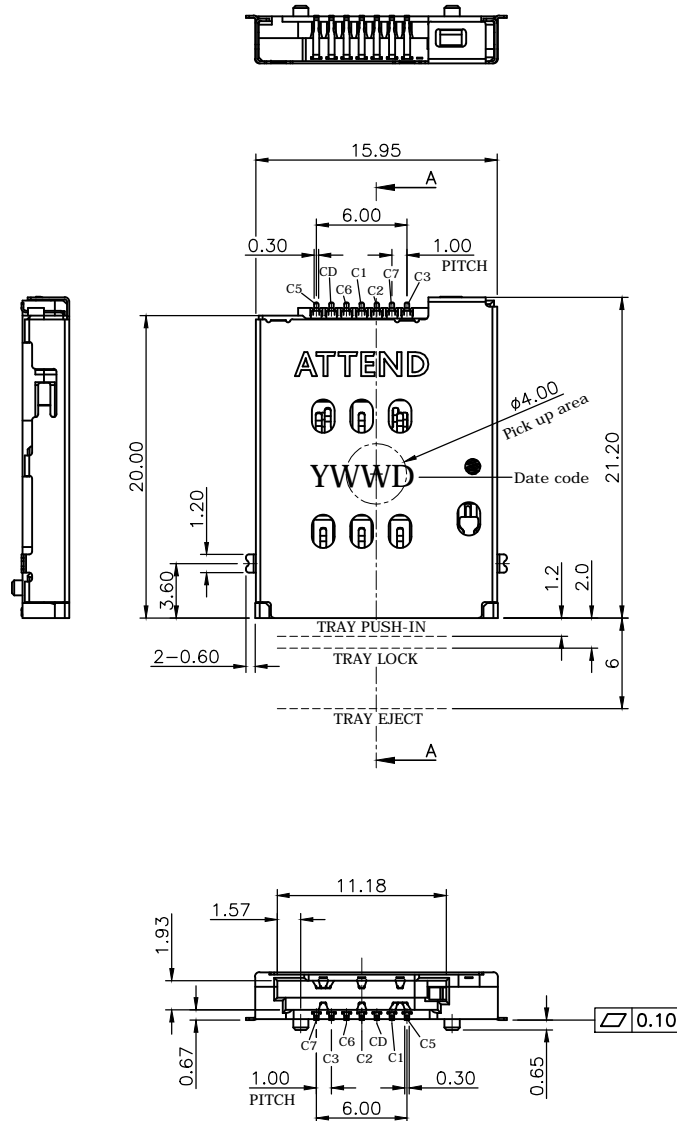

SECTION A-A

REV.	DESCRIPTION	DRAWN	DATE
	see sheet one		

Nano SIM pin assignment

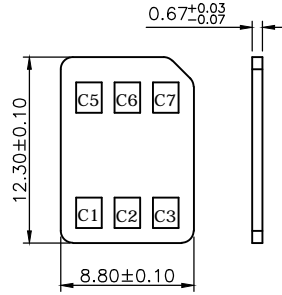

Pin NO.	Pin Name
C 1	VCC
C 2	RST
C 3	CLK
C 5	GND
C 6	VPP
C 7	I/O
CD	Card Detect Switch

Card Detect circuit: (Normal OPEN)

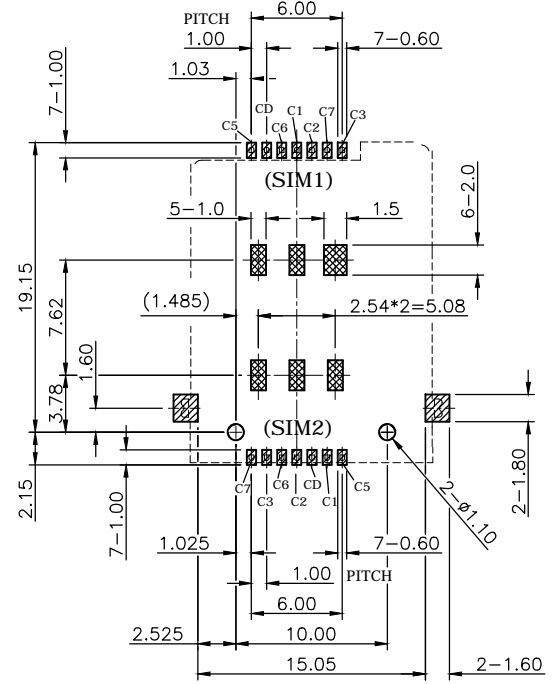
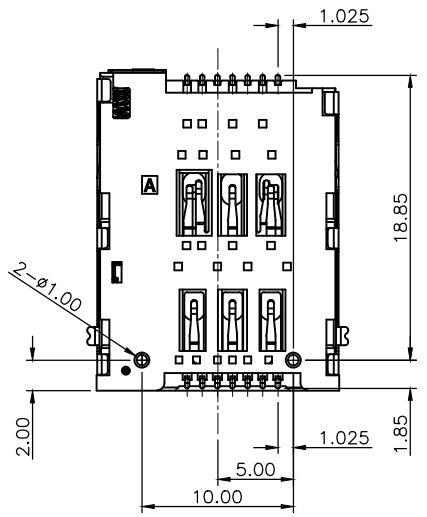
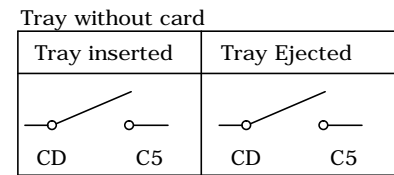
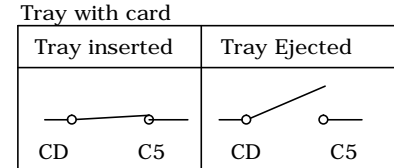

- SOLDER PAD
- KEEP OUT AREA

RECOMMENDED LAYOUT (TOP VIEW)
GENERAL TOLERANCE: ±0.05mm

UNLESS OTHERWISE SPECIFIED TOLERANCE

UNIT:	DECIMAL	LINEAR	ANGLES
mm	X.	±0.50	±5°
	X.X	±0.25	±3°
	X.XX	±0.12	±1°



www.attend.com.tw

DRAWN	Fros	2021/07/23	DRAWN NAME:	Dual Nano SIM Socket,
CHECKED	Tim	2021/07/23		Tray-Push Push, Lock w/Switch, G/F, Reel
APPROVED	Ken	2021/07/23	PRODUCT NO.	115U-B100
	SCALE	SHEET	SIZE	FILE NAME
	2/1	2/4	A4	115U-B100_B_1

REV.	DESCRIPTION	DRAWN	DATE
	see sheet one		

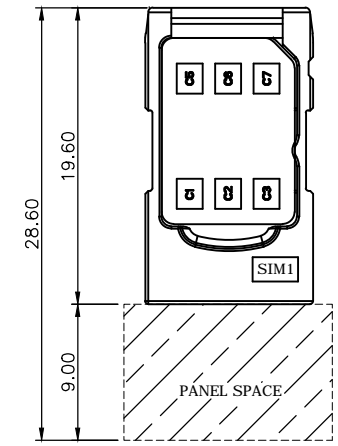
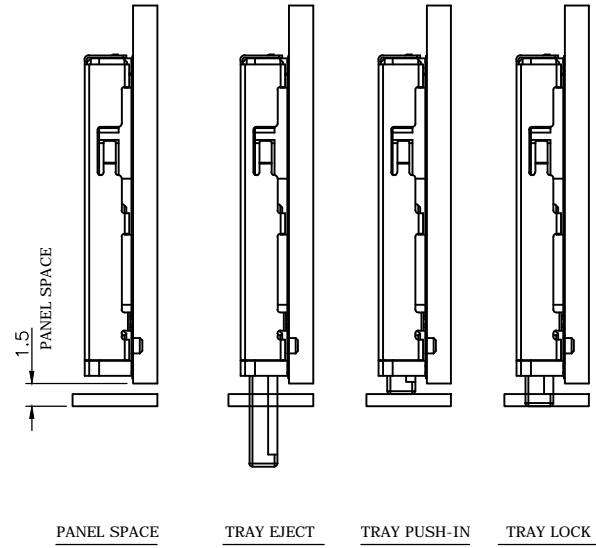
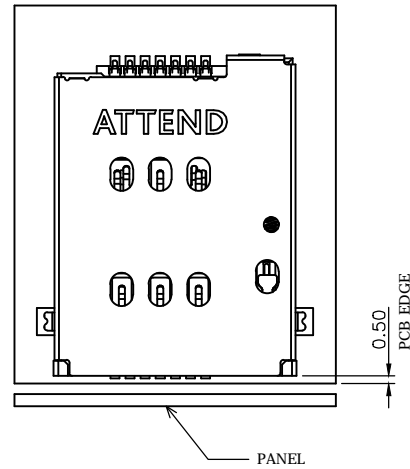

Length and form can be customized within 9.0mm.

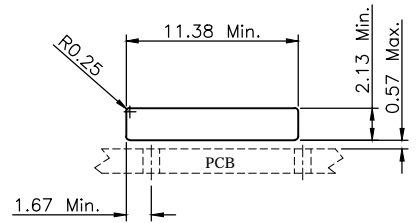

RECOMMENDED PANEL CUT OUT

Panel space & tray length

P/N	Length	PANEL SPACE
115U-T003	19.6mm	1.5
Reserved	19.6~28.6mm	1.5~10.5

UNLESS OTHERWISE SPECIFIED TOLERANCE

UNIT:	DECIMAL	LINEAR	ANGLES
mm	X.	±0.50	±5°
	X.X	±0.25	±3°
	X.XX	±0.12	±1°

ATTEND

www.attend.com.tw

DRAWN	Fros	2021/07/23	DRAWN NAME:
CHECKED	Tim	2021/07/23	Dual Nano SIM Socket, Tray-Push Push, Lock w/Switch, G/F, Reel
APPROVED	Ken	2021/07/23	PRODUCT NO. 115U-B100
SCALE	2/1	SHEET 3/4	SIZE A4
FILE NAME			115U-B100_B_1

REV.	DESCRIPTION	DRAWN	DATE
	see sheet one		

Nano SIM card assembly and disassembly:

ASSEMBLY

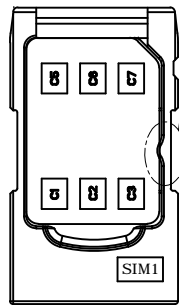
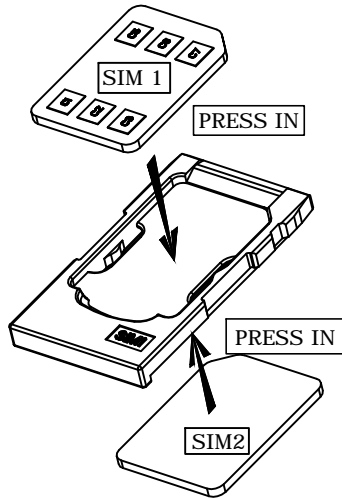



Card Clip hold Nano SIM card make it won't fall.

SIM1

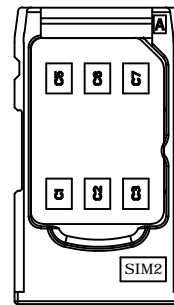
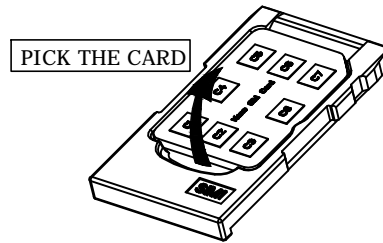
DISASSEMBLY



SIM2

UNLESS OTHERWISE SPECIFIED TOLERANCE					
UNIT:	DECIMAL	LINEAR	ANGLES		
mm	X.	±0.50	±5°	www.attend.com.tw	
	X.X	±0.25	±3°		
	X.XX	±0.12	±1°		
DRAWN	Fros	2021/07/23	DRAWN NAME:		
CHECKED	Tim	2021/07/23	Dual Nano SIM Socket, Tray-Push Push, Lock w/Switch, G/F, Reel		
APPROVED	Ken	2021/07/23	PRODUCT NO.	115U-B100	
	SCALE 2/1	SHEET 4/4	SIZE A4	FILE NAME	115U-B100_B_1

REV.	DESCRIPTION	DRAWN	DATE
1	INITIAL RELEASE	FROS	2021/07/23

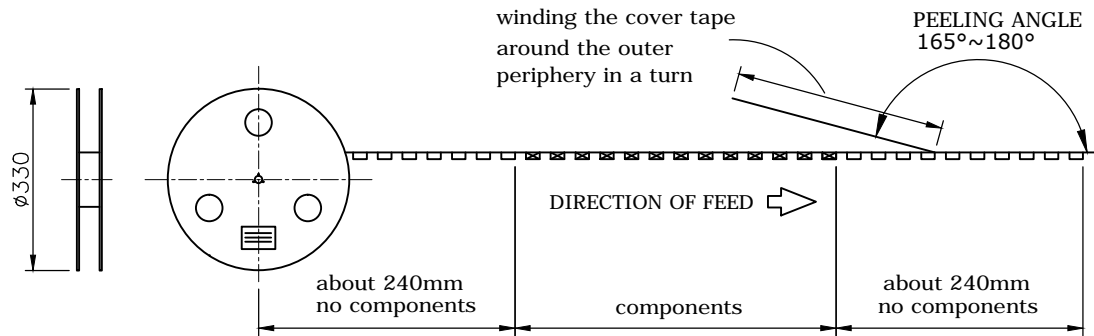

PACKAGING SPECIFICATION:

1. MATERIAL

- 1.1 Embossed Carrier Tape: PS Black
- 1.2 Top Cover Tape: PET
20-80g (Peel Speed 300mm/Minute)
- 1.3 Taping Reel: Paper

2. PACKING

- 2.1 Quantity:
550 Piece/Reel
3300 Piece/Outer Carton

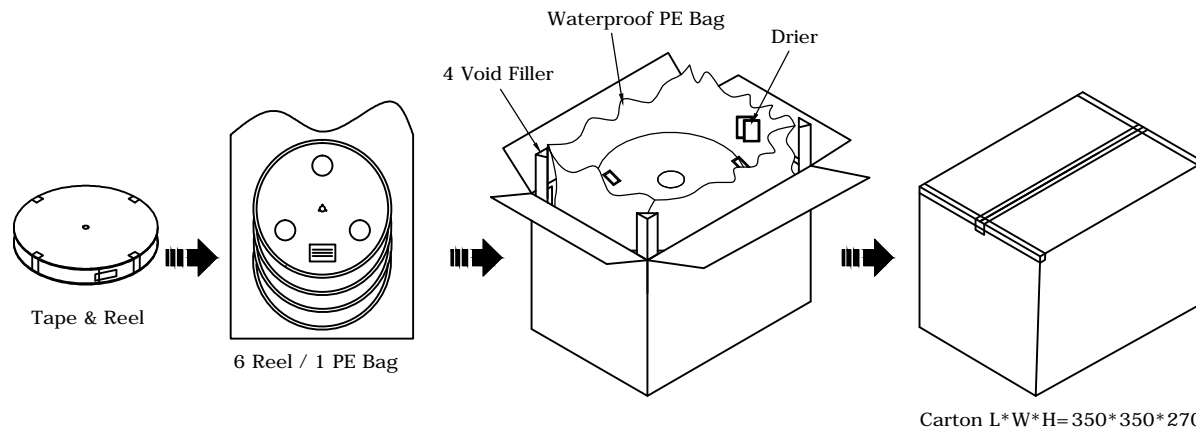
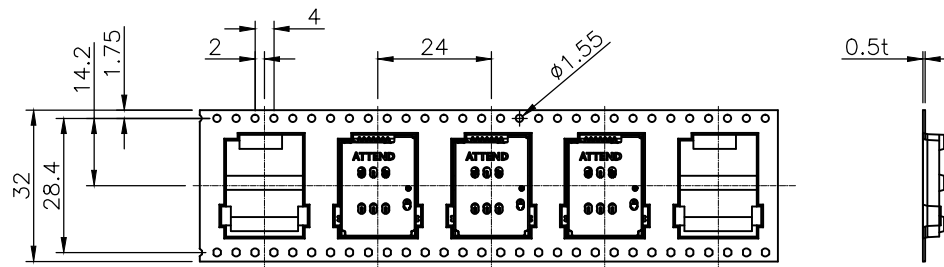

UNLESS OTHERWISE SPECIFIED TOLERANCE			
UNIT:	DECIMAL	LINEAR	ANGLES
mm	X.	±0.50	±5°
	X.X	±0.25	±3°
	X.XX	±0.12	±1°



www.attend.com.tw

DRAWN	Fros	2021/07/23	DRAWN NAME:	Dual Nano SIM Socket,
CHECKED	Tim	2021/07/23		Tray-Push Push, Lock w/Switch, G/F, Reel
APPROVED	Ken	2021/07/23	PRODUCT NO.	115U-B100
SCALE	N/A	SHEET	FILE NAME	115U-B100_D_1
		1/1	SIZE	A4