

**COPERCHIO-COVER**

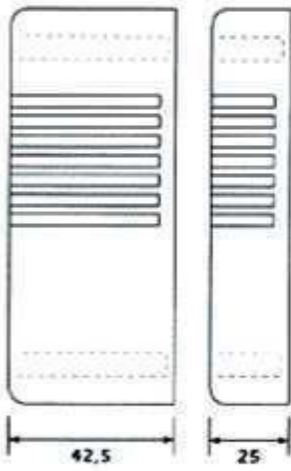

**120.65 CH**  
chiuso-closed

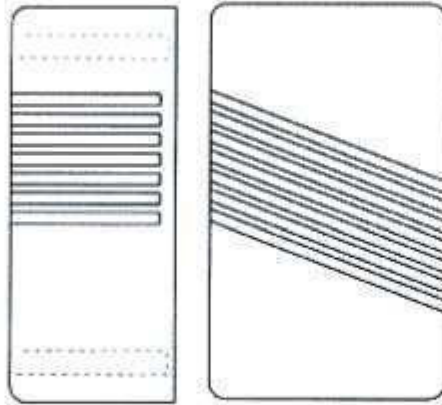

**120.65 BA**  
basso-low

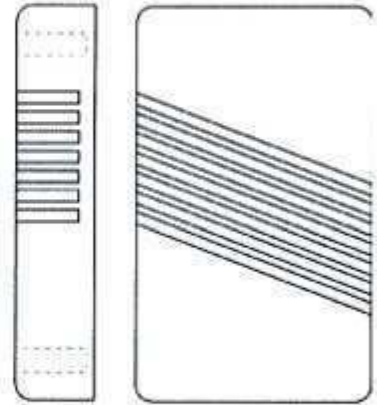

**120.65 AR**

areato lateralmente mm 0,3-lateral vented

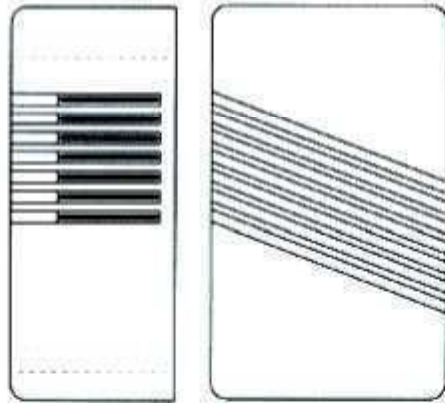
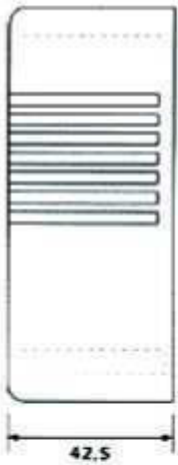

**120.65 VE**

ventilato anteriormente mm2,3-front vented

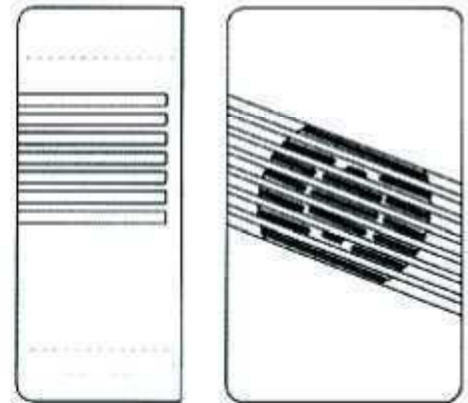

**120.65 MP**  
multipresa-multisocket

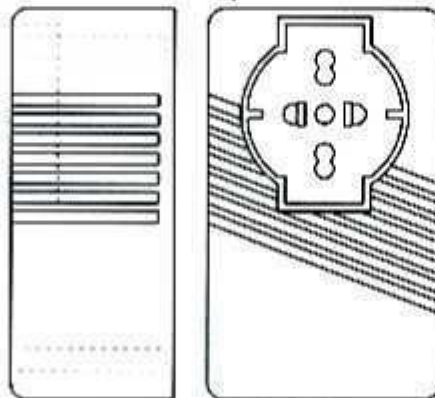

**120.65 FRU-MP**  
frutto-multipresa-universal socket

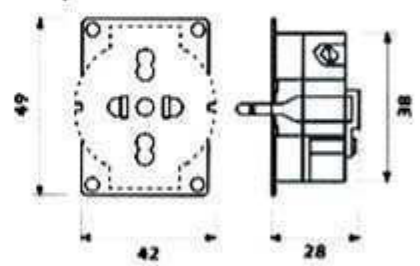

BASI-BASES

120.65 EV

120.65 EVT

120.65 SS

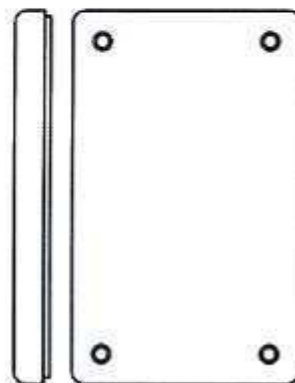
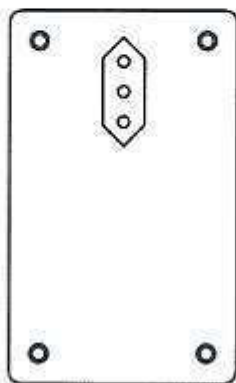
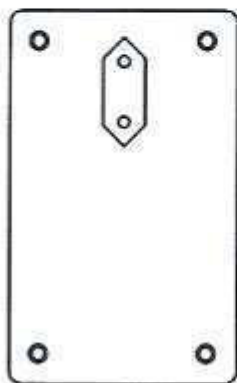
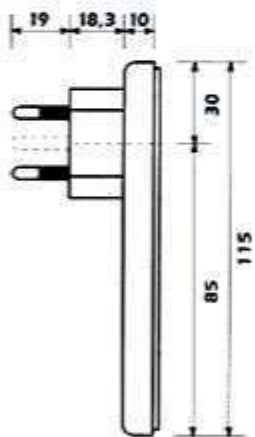

120.65 EO

120.65 EOT

120.65 SS/CO

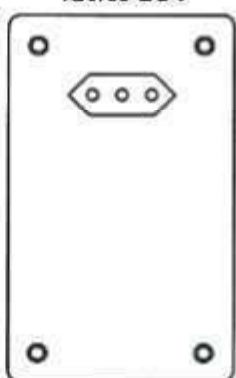
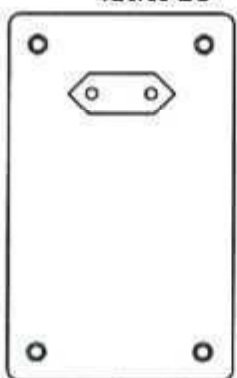

120.65 TV

120.65 TOT

