



Neohm | Neohm EP

TE Internal #: 2176081-7

Neohm EP, Through-Hole Resistors, Power Resistor, 10 x 3.5 mm, 2 Termination, Ammo Packed, 5 Through-Hole Resistor Tolerance

[View on TE.com >](#)

Passive Components > Resistors > Through-Hole Resistors

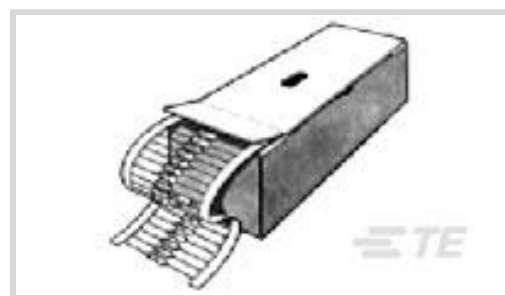

Resistor Type: **Power Resistor**

Through-Hole Resistor Dimensions: **10 x 3.5 mm**

Number of Terminations: **2**

Through-Hole Resistor Packaging Method: **Ammo Packed**

Through-Hole Resistor Tolerance: **5**

Features

Product Type Features

Product Type	Fixed Resistor
Resistor Type	Power Resistor
Element Type	Ceramic Composition, Wire Wound

Configuration Features

Number of Resistors	1
---------------------	---

Electrical Characteristics

Voltage Rating	500 V
Through-Hole Resistor Tolerance	5
Resistance Class	Up to 1kΩ
Through-Hole Resistor Resistance	100 Ω
Through-Hole Resistor Power Rating	1 W

Body Features

Lead Type	Axial-Leaded
-----------	--------------

Termination Features

Number of Terminations	2
Through-Hole Resistor Termination Type	Tinned Copper Leads

Mechanical Attachment

Through-Hole Resistor Mount Style	Axial Leaded
-----------------------------------	--------------

Dimensions

Through-Hole Resistor Dimensions	10 x 3.5 mm
----------------------------------	-------------

Usage Conditions

Operating Temperature Range	-55 – 155 °C
Temperature Coefficient	±300 ppm/°C

Packaging Features

Through-Hole Resistor Packaging Method	Ammo Packed
--	-------------

Product Compliance

[For compliance documentation, visit the product page on TE.com>](#)

EU RoHS Directive 2011/65/EU	Compliant
EU ELV Directive 2000/53/EC	Compliant
China RoHS 2 Directive MIIT Order No 32, 2016	No Restricted Materials Above Threshold
EU REACH Regulation (EC) No. 1907/2006	Current ECHA Candidate List: JUN 2020 (209) Candidate List Declared Against: JUN 2020 (209) Does not contain REACH SVHC
Halogen Content	Low Halogen - Br, Cl, F, I < 900 ppm per homogenous material. Also BFR/CFR/PVC Free
Solder Process Capability	Not reviewed for solder process capability

Product Compliance Disclaimer

This information is provided based on reasonable inquiry of our suppliers and represents our current actual knowledge based on the information they provided. This information is subject to change. The part numbers that TE has identified as EU RoHS compliant have a maximum concentration of 0.1% by weight in homogenous materials for lead, hexavalent chromium, mercury, PBB, PBDE, DBP, BBP, DEHP, DIBP, and 0.01% for cadmium, or qualify for an exemption to these limits as defined in the Annexes of Directive 2011/65/EU (RoHS2). Finished electrical and electronic equipment products will be CE marked as required by Directive 2011/65/EU. Components may not be CE marked. Additionally, the part numbers that TE has identified as EU ELV compliant have a maximum concentration of 0.1% by weight in homogenous materials for lead, hexavalent chromium, and mercury, and 0.01% for cadmium, or qualify for an exemption to these limits as defined in the Annexes of Directive 2000/53/EC (ELV). Regarding the REACH Regulation, the information TE provides on SVHC in articles for this part number is based on the latest European Chemicals Agency (ECHA) 'Guidance on requirements for substances in articles' posted at this URL: <https://echa.europa.eu/guidance-documents/guidance-on-reach>

Compatible Parts



TE Part # 1-2176045-7
EP 5W 3K3 5%



TE Part # 2176084-8
EP 7W (S) 150R 5%



TE Part # 1-2176078-2
EP 1W 680R 5%



TE Part # 2176045-3
EP 5W 15R 5%



TE Part # 1-1879927-9
EP 7W 4K7 5%



TE Part # 1-1879927-2
EP 7W 330R 5%



TE Part # 1879927-9
EP 7W 68R 5%



TE Part # 2176080-1
EP 9W 10R 5%



TE Part # 1-2176080-1
EP 9W 470R 5%



TE Part # 2176045-7
EP 5W 68R 5%



TE Part # 2176045-9
EP 5W 150R 5%



TE Part # 2176045-1
EP 5W 20R 5%



TE Part # 1-2176045-6
EP 5W 2K2 5%



TE Part # 1879927-1
EP 7W 100R 5%



TE Part # 1-1879927-7
EP 7W 2K2 5%



TE Part # 1-2176080-8
EP 9W 6K8 5%

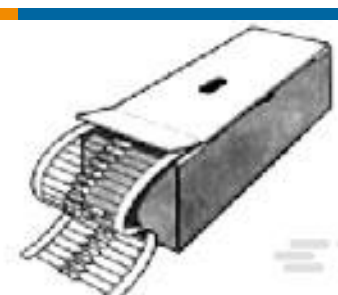

TE Part # 1-2176084-0
EP 7W (S) 330R 5%

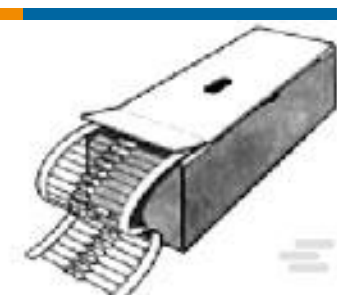

TE Part # 2176085-7
EP 9W (S) 100R 5%

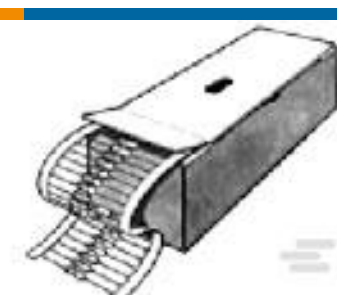

TE Part # 2176085-4
EP 9W (S) 33R 5%

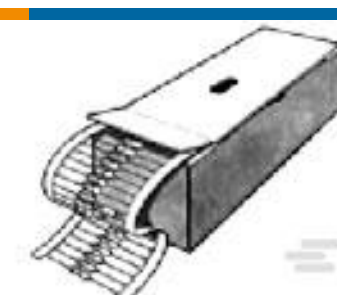

TE Part # 2176045-4
EP 5W 22R 5%

Also in the Series | **Neohm EP**



Through-Hole Resistors(161)

Customers Also Bought



TE Part #5-534237-1
03 MODII VRT SR CE 100/115

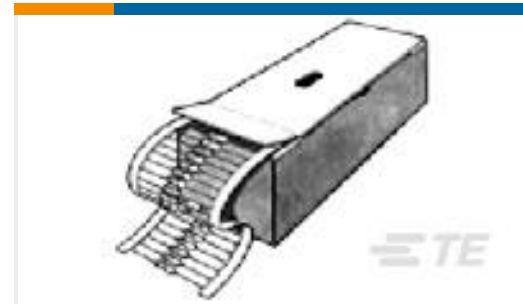

TE Part #2176082-1
EP 3W (S) 10R 5%



TE Part #2-1393222-0
V23061A1005A302=MINISTARKSTROM

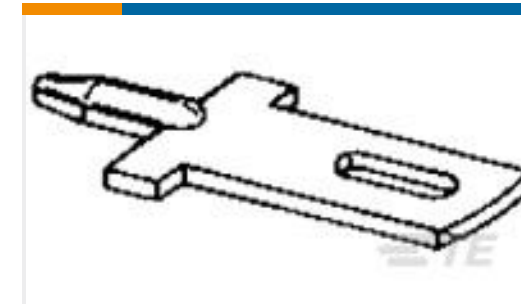

TE Part #735427-2
FASTON 110 PCB TAB .0315 X .550
TPBR



TE Part #881545-5
AMP SHUNT ASS'Y

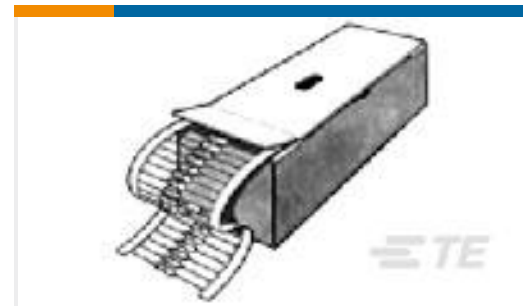

TE Part #2176081-5
EP 1W (S) 47R 5%

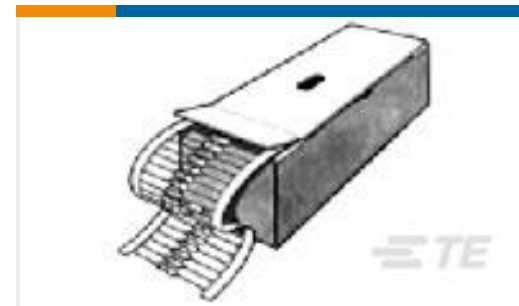

TE Part #2176081-4
EP 1W (S) 33R 5%

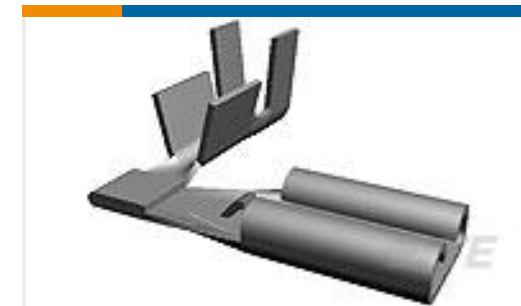

TE Part #62336-1
FASTON 110 FLAG REC 22-18 AWG
PTPBR



TE Part #2-1614892-5
CPF 0805 1K47 0.1% 25PPM 1K RL



TE Part #1-215460-2
MICRO-MATCH FEM.SE

Documents

Product Drawings

[EP 1W \(S\) 100R 5%](#)

English

CAD Files

[3D PDF](#)

3D

[Customer View Model](#)

[ENG_CVM_CVM_2176081-7_BA.2d_dxf.zip](#)



English

Customer View Model

[ENG_CVM_CVM_2176081-7_BA.3d_igs.zip](#)

English

Customer View Model

[ENG_CVM_CVM_2176081-7_BA.3d_stp.zip](#)

English

By downloading the CAD file I accept and agree to the [Terms and Conditions](#) of use.

Datasheets & Catalog Pages

[Wirewound Anti-Surge resistor - Type EP Series - Tyco Electronics Passives](#)

English

Product Environmental Compliance

[TE Material Declaration](#)

English