

Features

- Single-Turn / Cermet / Industrial / Sealed
- Miniature package
- Rotor designed for automatic machine adjust interface
- Withstands harsh environments and immersion cleaning processes

■ Available on tape and reel packaging (see page 71)

LOMEX KFT
 1134 Budapest Lehel u. 17
 Tel.: 349-5906 Fax.: 320-3292
 Honlap: www.lomex.hu E-mail: info@lomex.hu

3362 - 1/4" Square Trimming Potentiometer

Electrical Characteristics

Standard Resistance Range 10 to 2 megohms
 (see standard resistance table)
 Resistance Tolerance ±10% std.
 (tighter tolerance available)
 Absolute Minimum Resistance 1% or 2 ohms
 (whichever is greater)
 Contact Resistance Variation 1% or 3 ohms max.
 (whichever is greater)
 Adjustability
 Voltage ±0.05%
 Resistance ±0.15%
 Resolution Infinite
 Insulation Resistance 500 vdc.
 1,000 megohms min.

Dielectric Strength
 Sea Level 900 vac
 80,000 Feet 350 vac
 Adjustment Angle 240° nom.

Environmental Characteristics

Power Rating (300 volts max.)
 70°C 0.50 watt
 125°C 0 watt
 Temperature Range -55°C to +125°C
 Temperature Coefficient ±100ppm/°C
 Seal Test 85°C Fluorinert*
 Humidity MIL-STD-202 Method 103
 96 hours
 (2% ΔTR; 10 Megohms IR)
 Vibration 30G (1% ΔTR; 1% ΔVR)
 Shock 100G (1% ΔTR; 1% ΔVR)
 Load Life 1,000 hours 0.5 watt @ 70°C
 (3% ΔTR; 3% or 3 ohms, whichever is greater, CRV)
 Rotational Life 200 cycles
 (4% ΔTR; 3% or 3 ohms, whichever is greater, CRV)

Physical Characteristics

Mechanical Angle 270° nom.
 Torque 3.0 oz-in. max.
 Stop Strength 7.0 oz-in. min.
 Terminals Solderable pins
 Weight 0.02 oz.
 Marking Resistance code, terminal numbers, manufacturer's model number, style and date code
 Wiper Positioned at 50% nominal
 Flammability U.L. 94V-0
 Standard Packaging 50 pcs. per tube
 Adjustment Tool H-90

FLUORINERT IS A REGISTERED TRADEMARK OF 3M CO.

Common Dimensions Top Adjust

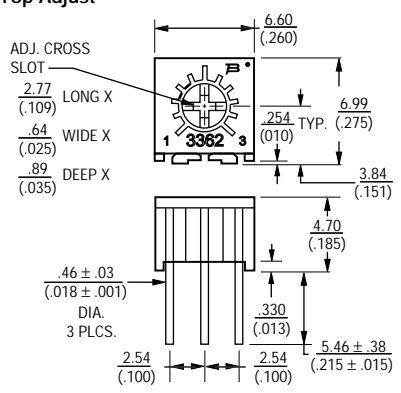

3362H

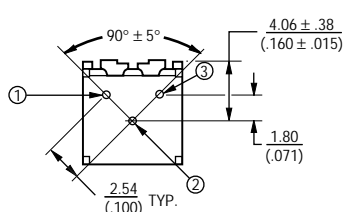

3362P

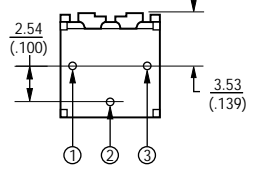

3362R

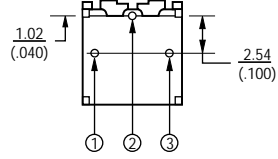

3362U

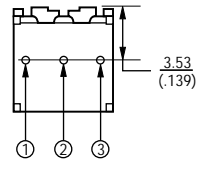

Common Dimensions Side Adjust

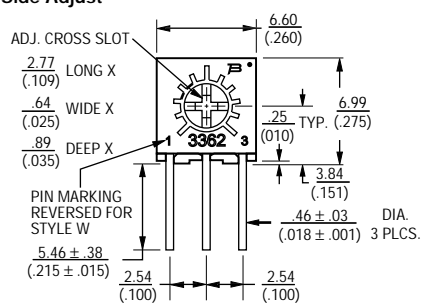

3362M

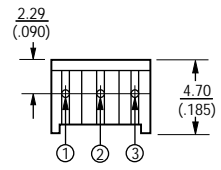

3362S

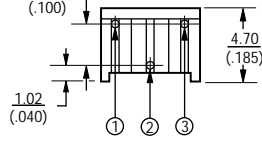

3362W

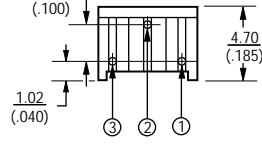

3362X

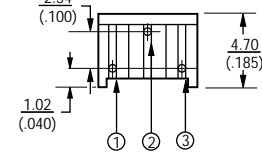

TOLERANCES: ± 0.25 (.010) EXCEPT WHERE NOTED

DIMENSIONS ARE: METRIC (INCHES)

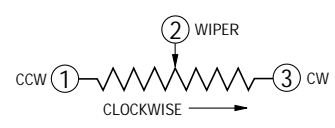

Specifications are subject to change without notice.