

THIS DRAWING IS UNPUBLISHED. RELEASED FOR PUBLICATION
 © COPYRIGHT - By - ALL RIGHTS RESERVED.

LOC	DIST	REVISIONS					
ES	00	P	LTR	DESCRIPTION	DATE	DWN	APVD
		D		REVISED ECR-16-005069	07APR2016	T.Q	W.H

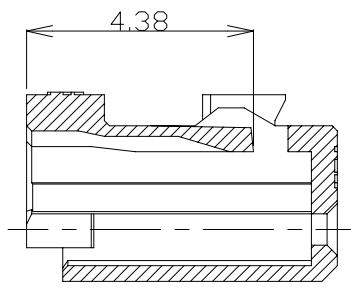

SECTION A-A

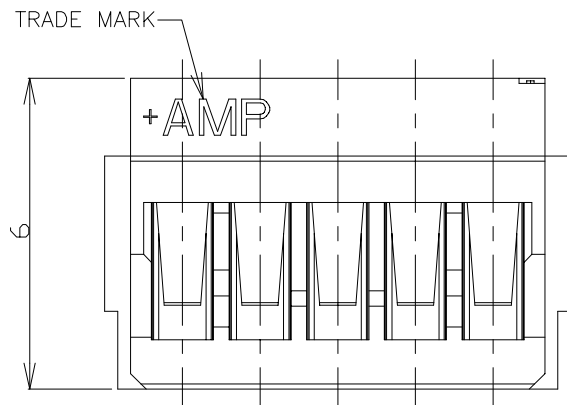
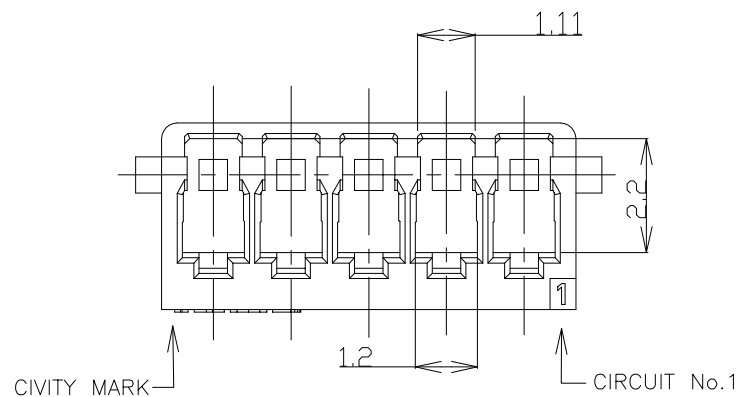
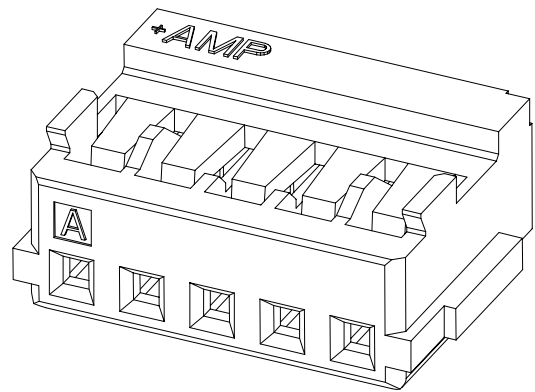
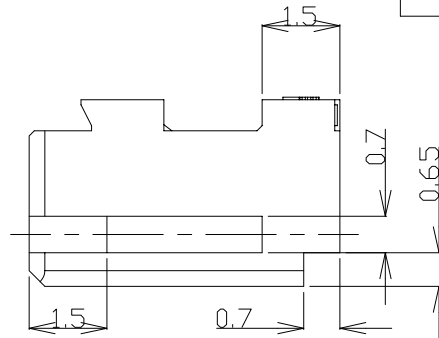
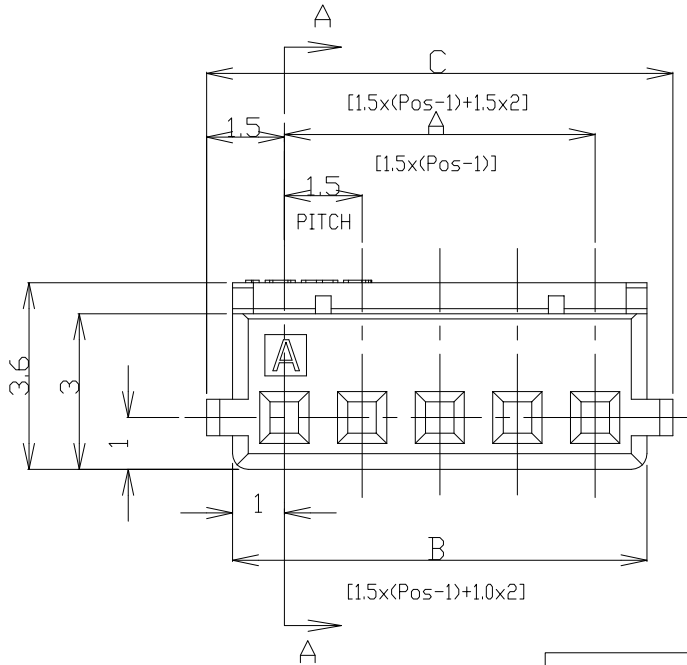

0.30	31.5	30.5	28.5	20	8-353908-0	2-353908-0
0.29	30.0	29.0	27.0	19	7-353908-9	1-353908-9
0.27	28.5	27.5	25.5	18	7-353908-8	1-353908-8
0.26	27.0	26.0	24.0	17	7-353908-7	1-353908-7
0.24	25.5	24.5	22.5	16	7-353908-6	1-353908-6
0.23	24.0	23.0	21.0	15	7-353908-5	1-353908-5
0.21	22.5	21.5	19.5	14	7-353908-4	1-353908-4
0.20	21.0	20.0	18.0	13	7-353908-3	1-353908-3
0.19	19.5	18.5	16.5	12	7-353908-2	1-353908-2
0.17	18.0	17.0	15.0	11	7-353908-1	1-353908-1
0.16	16.5	15.5	13.5	10	7-353908-0	1-353908-0
0.14	15.0	14.0	12.0	9	6-353908-9	353908-9
0.13	13.5	12.5	10.5	8	6-353908-8	353908-8
0.13	12.0	11.0	9.0	7	6-353908-7	353908-7
0.10	10.5	9.5	7.5	6	6-353908-6	353908-6
0.09	9.0	8.0	6.0	5	6-353908-5	353908-5
0.07	7.5	6.5	4.5	4	6-353908-4	353908-4
0.06	6.0	5.0	3.0	3	6-353908-3	353908-3
0.04	4.5	3.5	1.5	2	6-353908-2	353908-2
WEIGHT (g)	DIMENSIONS			Pos	BLUE	WHITE
	C	B	A		P/N	

- NOTES:
 1. APPLICABLE WIRE SIZE: AWG#24~#30(0.22mm²~0.05mm²).
 INSULATION DIAMETER: 0.7mm~1.03mm.
 2. USE WITH RECEPTACLE CONTACT P/N
 AWG#24~#28: 353907-1, 353918-1(L/P)

GENERAL TOLERANCE

10 ≥	±0.2
30 ≥ > 10	±0.25
100 ≥ > 30	±0.3
ANGLES: ±3°	

THIS DRAWING IS A CONTROLLED DOCUMENT.

DIMENSIONS:	TOLERANCES UNLESS OTHERWISE SPECIFIED:
mm	
0 PLC	± -
1 PLC	± -
2 PLC	± -
3 PLC	± -
4 PLC	± -
ANGLES	± -
MATERIAL	FINISH
66NYLON UL94 V-0	

WIRE RANGE		INSULATION DIA	
DWN H.HOSHINO 26.APR.'97		CHK J.TANIGAWA 26.APR.'97	
APVD S.KUBONOHI 10.MAR.'99		NAME	
PRODUCT SPEC		AMP MINI COMMON TERMINATED (CT) CONNECTOR 1.5mm PITCH HOUSING, CRIMP TYPE	
APPLICATION SPEC		SIZE	CAGE CODE
114-5245		A3	00779
WEIGHT		DRAWING NO	
CUSTOMER DRAWING		C=353908	
SCALE NON		SHEET	REV
		1 of 2	D

4

3

2

1

THIS DRAWING IS UNPUBLISHED.

RELEASED FOR PUBLICATION

LOC

DIST

REVISIONS

© COPYRIGHT - By -

ALL RIGHTS RESERVED.

ES

00

P

LTR

DESCRIPTION

DATE

DWN

APVD

SEE SHEET 1

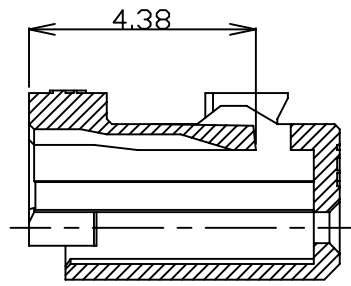
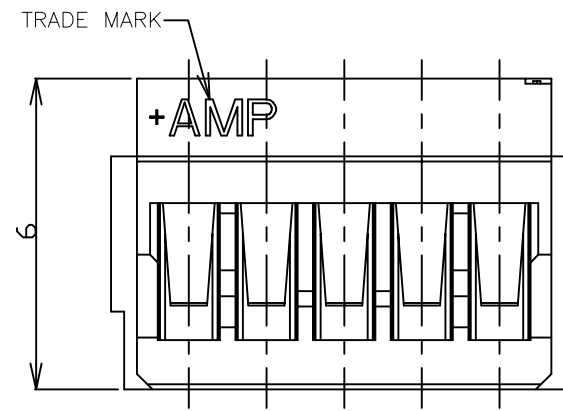
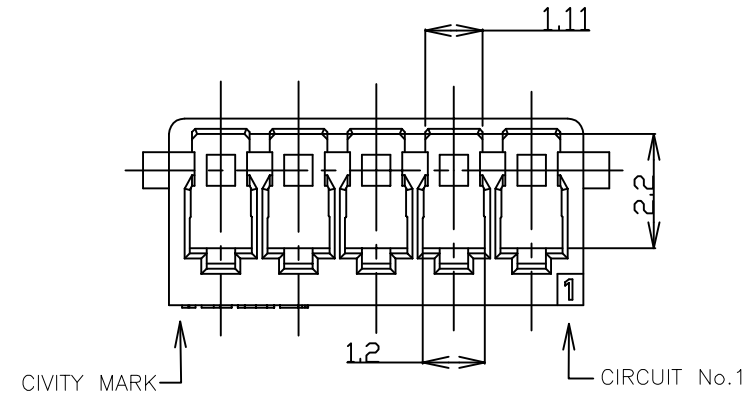
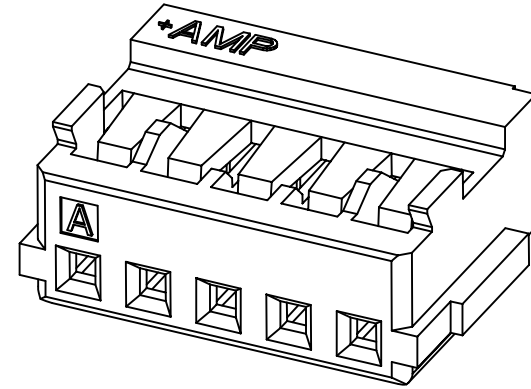

SECTION A-A

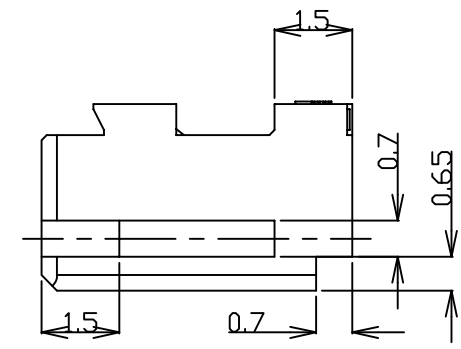
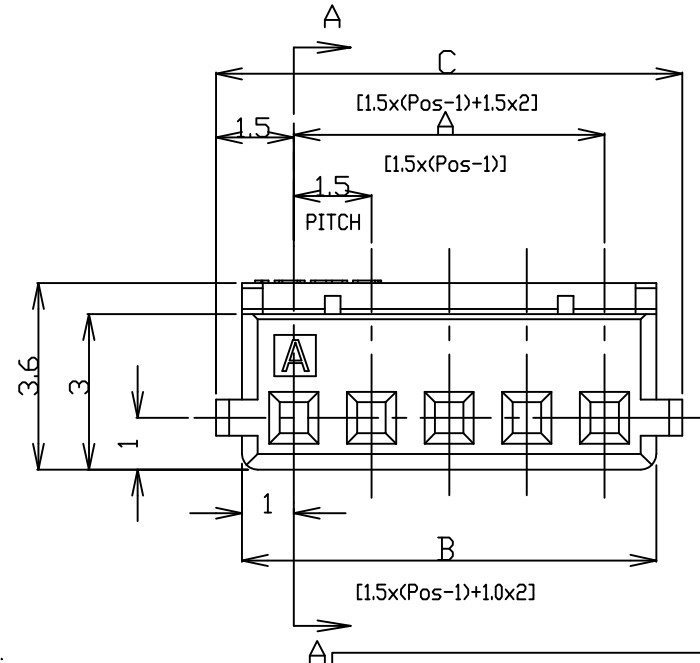

0.30	31.5	30.5	28.5	20	4-353908-0
0.29	30.0	29.0	27.0	19	3-353908-9
0.27	28.5	27.5	25.5	18	3-353908-8
0.26	27.0	26.0	24.0	17	3-353908-7
0.24	25.5	24.5	22.5	16	3-353908-6
0.23	24.0	23.0	21.0	15	3-353908-5
0.21	22.5	21.5	19.5	14	3-353908-4
0.20	21.0	20.0	18.0	13	3-353908-3
0.19	19.5	18.5	16.5	12	3-353908-2
0.17	18.0	17.0	15.0	11	3-353908-1
0.16	16.5	15.5	13.5	10	3-353908-0
0.14	15.0	14.0	12.0	9	2-353908-9
0.13	13.5	12.5	10.5	8	2-353908-8
0.13	12.0	11.0	9.0	7	2-353908-7
0.10	10.5	9.5	7.5	6	2-353908-6
0.09	9.0	8.0	6.0	5	2-353908-5
0.07	7.5	6.5	4.5	4	2-353908-4
0.06	6.0	5.0	3.0	3	2-353908-3
0.04	4.5	3.5	1.5	2	2-353908-2
WEIGHT (g)	C	B	A	Pos	WHITE
	DIMENSIONS				P/N

- NOTES:
- △ APPLICABLE WIRE SIZE: AWG#24~#30(0.22mm²~0.05mm²).
INSULATION DIAMETER: 0.7mm~1.03mm.
 - USE WITH RECEPTACLE CONTACT P/N
AWG#24~#28: 353907-1, 353918-1(L/P)
 - COMPLY WITH GLOW WIRE REQUIREMENTS FOR PARTS OF
NON-METALLIC MATERIAL SUPPORTING A CURRENT-CARRYING
CONNECTION DETAILED IN IEC 60335-1, SECTION 30(GWT).

THIS DRAWING IS A CONTROLLED DOCUMENT.		DWN	H.HOSHINO	26.APR.'97		AMP MINI COMMON TERMINATED (CT) CONNECTOR 1.5mm PITCH HOUSING, CRIMP TYPE		
		CHK	J.TANIGAWA	26.APR.'97				
		APVD	S.KUBONOHI	10.MAR.'99				
		PRODUCT SPEC						
DIMENSIONS: mm		TOLERANCES UNLESS OTHERWISE SPECIFIED:			NAME			
		0 PLC ± -			108-60025			
		1 PLC ± -			APPLICATION SPEC			
		2 PLC ± -			114-5245			
		3 PLC ± -			SIZE			
		4 PLC ± -			CAGE CODE			
		ANGLES ± -			DRAWING NO			
MATERIAL		FINISH			RESTRICTED TO			
6 NYLON		-			A3			
UL94 V-2					00779			
					C=353908			
					SCALE			
					NON			
					SHEET			
					2 of 2			
					REV			
					D			
					CUSTOMER DRAWING			