

DSUB

706



706-1

Material insulator	PBT, UL94V-0
Plating contact	Selective Au
Plating shell	Sn
Packaging	Standard
Material contact	Copper alloy
Rated current	3,0 A
Withstand voltage	500 V RMS for 1 Minute
Operating temperature	-55°C to +105°C
Pincount	25
Orientation to PCB	Vertical
No of rows	2
Cable termination	IDC
Industry standard	DSUB
Mounting option DSUB	No accessories
Color	black

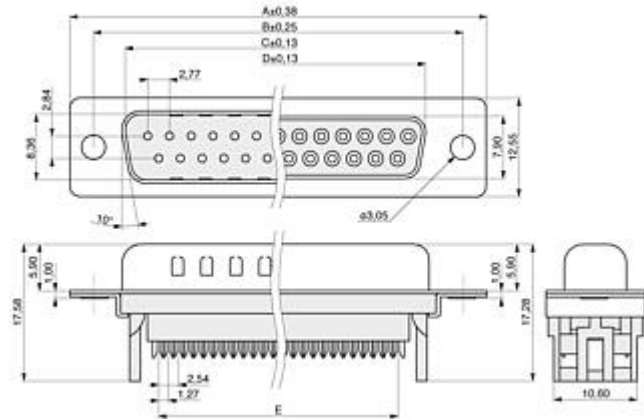

MPE Garry GmbH
Schäfflerstraße 13
87629 Füssen/Germany

Telefon: +49 (0) 83 62 / 91 56-0
Fax: +49 (0) 83 62 / 91 56-500
E-Mail: vk@mpe-connector.de