

ROHS Compliant



台灣駿品端子股份有限公司

TAIWAN KING PIN TERMINAL CO.,LTD

新北市樹林區俊德街 23 號

TEL:886-2-26895596.26886112 FAX:886-2-26886110

E-mail:info@tkp.com.tw http://www.tkp.com.tw

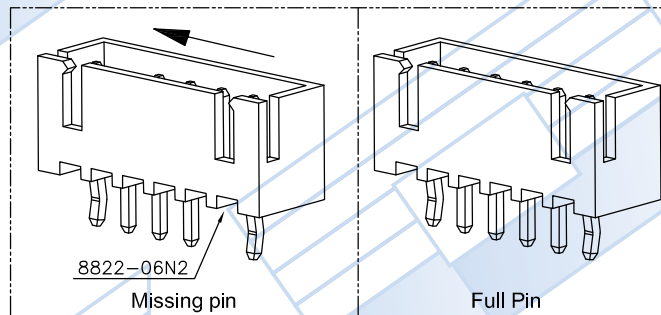
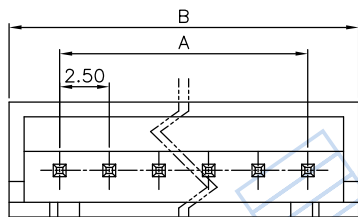

- NOTE :
- \* Material : Nylon UL 94V-0
  - \* Color : White / Yellow / Black / Blue / Red
  - \* Contact : Brass
  - \* Finish : Plated Tin over Nickel
  - \* Electrical rating :UL 30V 3A, AC/DC  
CSA 125V 3A, AC/DC
  - \* .025"(0.64mm) straight square pins
  - \* Mates with 8821 series housings
  - \* Friction lock
  - \* 2-20 circuits available
  - \* Universal drawing for full pin & missing pin

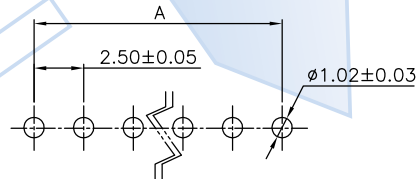
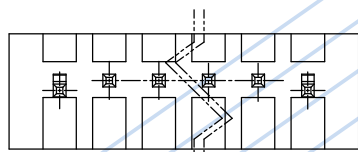
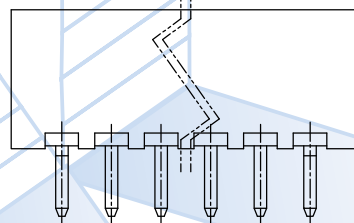
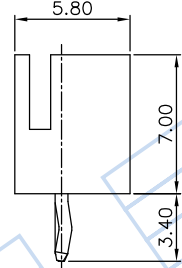
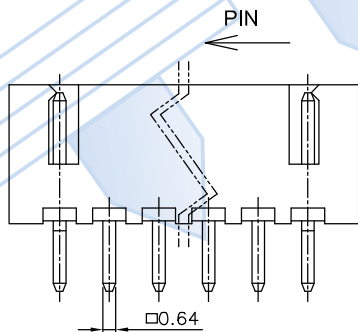

RECOMMENDED PCB LAYOUT



CIRCUITS	PART NO.	DIM. A	DIM. B	CIRCUITS	PART NO.	DIM. A	DIM. B
2	8822-02	2.50	7.50	12	8822-12	27.50	32.50
3	8822-03	5.00	10.00	13	8822-13	30.00	35.00
4	8822-04	7.50	12.50	14	8822-14	32.50	37.50
5	8822-05	10.00	15.00	15	8822-15	35.00	40.00
6	8822-06	12.50	17.50	16	8822-16	37.50	42.50
7	8822-07	15.00	20.00	17	8822-17	40.00	45.00
8	8822-08	17.50	22.50	18	8822-18	42.50	47.50
9	8822-09	20.00	25.00	19	8822-19	45.00	50.00
10	8822-10	22.50	27.50	20	8822-20	47.50	52.50
11	8822-11	25.00	30.00				



PART NO.	8822-XX			Part NO.	Material	Color	Remark	APPROVAL
TITLE	2.50mm Wire to Board			8822-XX	Nylon UL 94V-0	White		DRAWN: 高瑋瑩
				8822-XX-Y	Nylon UL 94V-0	Yellow		
				8822-XX-B	Nylon UL 94V-0	Black		
				8822-XXNXX	Nylon UL 94V-0	White		
				8822-XX-BL	Nylon UL 94V-0	Blue		
8822-XX-R	Nylon UL 94V-0	Red	CHECKED: 張明遠					
THIRD ANGLE	SCALE	UNIT	SHEET NO	TOLERANCE	DATE	ODD NUMBERS	REV	APPROVED: 陳泓宇
	2:1	mm	1/1	.X± 0.30 .XXX±0.10 .XX± 0.20 ANGLE±2°	2012.02.01	ENG951292	A3	
	250-020		A250-009					