

## AKZ710/..-7.62-V-GREEN







PTR

A Phoenix Mecano Brand

## Technical Data

Wire sizes		Insulating Material	
Solid min	0.2 mm <sup>2</sup>	Material	PA 6.6
Solid max	4.0 mm <sup>2</sup>	Flammability Class	UL 94 V-0
Stranded (flexible) min	0.2mm <sup>2</sup>	<b>Temperatures</b>	
Stranded (flexible) max	2.5 mm <sup>2</sup>	Operating Temperature (without mech. load)	-40 °C - 105 °C
Stranded with Ferrule min	0.25 mm <sup>2</sup>	Store Temperature	-40 °C - 105 °C
Stranded with Ferrule max	2.5 mm <sup>2</sup>	<b>Wave Soldering Process</b>	
<b>Dimensions</b>		Soldering Temperature, recommended	260 °C
Stripped Length	8.0 mm	Peak Soldering Time, recommended	3-4 s
PCB Hole Diameter	1.3 mm	<b>Reflow Process</b>	
<b>Materials</b>		Soldering Temperature, recommended	-
Clamp	Brass	Peak Soldering Time, recommended	-
Screw	Steel		
Solder Tab	Copper Alloy		

## Colours

	GREEN, RAL 6018
	BLACK, RAL 9011
	PEBBLE GREY, RAL 7032
	BLUE, RAL 5015
	LIGHT GREEN, similar RAL 6018

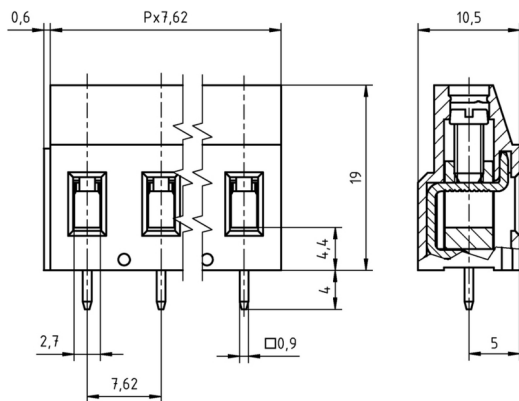

Colours according to RAL, there may be variations on colour due to production conditions. Special colours on request.



## Order Data (Spacing 7.62 mm)

Poles	Width (mm)	Article Designation	Article Number	PU
2	15.84	AKZ710/2-7.62-V-GREEN	50710020213 E	100
3	23.46	AKZ710/3-7.62-V-GREEN	50710030213 E	100
4	31.08	AKZ710/4-7.62-V-GREEN	50710040213 E	100
5	38.70	AKZ710/5-7.62-V-GREEN	50710050213 E	100
6	46.32	AKZ710/6-7.62-V-GREEN	50710060213 D	50
7	53.94	AKZ710/7-7.62-V-GREEN	50710070213 D	50
8	61.56	AKZ710/8-7.62-V-GREEN	50710080213 D	50
9	69.18	AKZ710/9-7.62-V-GREEN	50710090213 D	50
10	76.80	AKZ710/10-7.62-V-GREEN	50710100213 D	50
11	84.42	AKZ710/11-7.62-V-GREEN	50710110213 D	50
12	92.04	AKZ710/12-7.62-V-GREEN	50710120213 D	50

## Accessoires

Figure	Designation	Article Number
	Bridge, 2-pole, insulated, BRI/2-7.5/7.62-L8.2-LIGHT GREY	Order Data: 50000000017
	Screw Cover SC-AK700-YELLOW	Order Data: 50700000004

## Ratings

UseGroup	cRU <sup>®</sup> US			VDE	
	B	C	D		
Rated Voltage	300 V	150 V	300 V	750 V	
Rated Current	20 A	20 A	10 A	24 A	
Rated Wire Size				min	max
- solid	AWG 30-12	AWG 30-12	AWG 30-12	0.5 mm <sup>2</sup>	4.0 mm <sup>2</sup>
- stranded	AWG 30-12	AWG 30-12	AWG 30-12	0.5 mm <sup>2</sup>	2.5 mm <sup>2</sup>
Torque	0.45 Nm	0.45 Nm	0.45 Nm	0.50 Nm	
Screw Size	M3	M3	M3	M3	
Test Voltage	1.60 kV	1.30 kV	1.60 kV	3.0 kV	