

AN7560Z

BTL output power IC for car audio

■ Overview

The AN7560Z is an audio power IC developed as the sound output of car audio (35 W by 4-ch.). A capacitor and resistor to stop oscillation are built in between the output pin and GND so that a space saving of set is possible. Also, it incorporates a perfect muting circuit without shock noise so that a shock noise design under the set transient condition can be made easily when used together with its standby function. In addition, it incorporates various protection circuits to protect the IC from destruction by GND-open-shortcircuit to ground and power supply surge which are the important subject of power IC protection. This IC will largely contribute to a high reliability design of the equipment.

■ Features

- A pattern layout in which input and output pattern do not intersect each other on single-sided printed circuit board is possible.
- Incorporating various protection circuits (temperature, shortcircuit to V_{CC} , V_{CC} -open short circuit to V_{CC} , shortcircuit to GND, GND-open short circuit to GND, overvoltage, power supply surge, and ASO, etc.)
- Built-in standby function (shock noise-free when STB-on/off)
- Built-in muting function (shock noise-free when Mute-on/off)
- External components reduction
- Provided with beep sound input pin
- Equipped with auxiliary sound input pin

■ Applications

- Car stereo, miniature audio component, karaoke and other audio equipment.

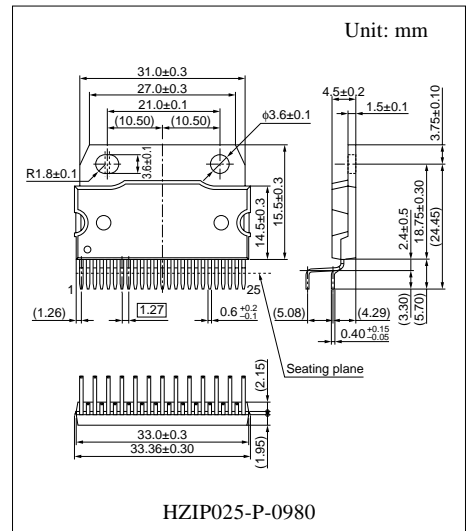

■ Block Diagram

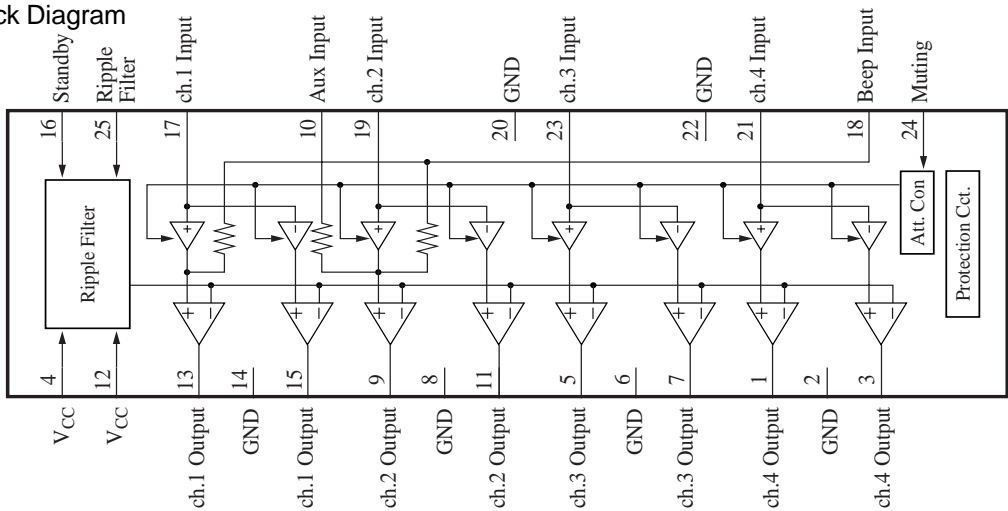

■ Pin Descriptions

Pin No.	Description	Pin No.	Description
1	ch.4 Output (+)	14	GND(Output ch.1)
2	GND (Output ch.4)	15	ch.1 Output (-)
3	ch.4 Output (-)	16	Standby
4	V _{CC}	17	ch.1 Input
5	ch.3 Output (+)	18	Beep Sound Input
6	GND(Output ch.3)	19	ch.2 Input
7	ch.3 Output (-)	20	GND (Input)
8	GND (Output ch.2)	21	ch.4 Input
9	ch.2 Output (+)	22	GND (Sub)
10	Auxiliary sound input	23	ch.3 Input
11	ch.2 Output (-)	24	Muting
12	V _{CC}	25	Ripple Filter
13	ch.1 Output (+)		

■ Absolute Maximum Ratings

Parameter	Symbol	Rating	Unit
Supply voltage *2	V _{CC}	25	V
Peak supply voltage *3	V _{surge}	65	V
Supply current	I _{CC}	12	A
Power dissipation *4	P _D	59	W
Operating ambient temperature *1	T _{opr}	-30 to +85	°C
Storage temperature *1	T _{stg}	-55 to +150	°C

Note) *1 : All items are at T_a = 25°C, except for the operating ambient temperature and storage temperature.

*2 : Without signal

*3 : Time = 0.2 s.

*4 : Power dissipation at T_a = 85°C.

■ Recommended Operating Range

Parameter	Symbol	Range	Unit
Supply voltage	V_{CC}	8.0 to 18.0	V

■ Electrical Characteristics at $V_{CC} = 13.2$ V, $f = 1$ kHz, $T_a = 25^\circ\text{C}$

Parameter	Symbol	Conditions	Min	Typ	Max	Unit
Quiescent current	I_{CQ}	$R_g = 10\text{ k}\Omega$, $R_L = 4\ \Omega$	—	300	450	mA
Standby current	I_{STB}	$R_g = 10\text{ k}\Omega$, $R_L = 4\ \Omega$	—	1	10	μA
Output noise voltage*1	V_{NO}	$R_g = 10\text{ k}\Omega$, $R_L = 4\ \Omega$	—	0.15	0.5	mV[rms]
Voltage gain	G_V	$V_{IN} = 40\text{ mV[rms]}$, $R_L = 4\ \Omega$	32	34	36	dB
Total harmonic distortion 1	THD1	$V_{IN} = 40\text{ mV[rms]}$, $R_L = 4\ \Omega$	—	0.05	0.2	%
Maximum output power 1	P_{O1}	THD = 10%, $R_L = 4\ \Omega$	16	19.5	—	W
Ripple rejection*1	RR	$R_g = 10\text{ k}\Omega$, $R_L = 4\ \Omega$ $V_R = 1\text{ V[rms]}$, $f_R = 1\text{ kHz}$	60	68	—	dB
Channel balance	CB	$V_{IN} = 40\text{ mV[rms]}$, $R_L = 4\ \Omega$	—	0	1	dB
Cross-talk	CT	$R_g = 10\text{ k}\Omega$, $R_L = 4\ \Omega$ $V_{IN} = 40\text{ mV[rms]}$	60	70	—	dB
Output offset voltage	V_{OFF}	$R_g = 10\text{ k}\Omega$, $R_L = 4\ \Omega$	-250	0	250	mV
Muting effect*1	MT	$V_{IN} = 40\text{ mV[rms]}$, $R_L = 4\ \Omega$	70	86	—	dB
Input impedance	Z_I	$V_{IN} = \pm 0.3\ V_{DC}$	24	30	36	k Ω
Shock noise*2	V_S	$R_g = 10\text{ k}\Omega$, $R_L = 4\ \Omega$, $V_{MUTE} = 5\text{ V}$ $V_{STB} = \text{on/off}$, 50 Hz HPF	-100	0	100	mV[0-P]
Total harmonic distortion 2	THD2	$V_{IN} = 20\text{ mV[rms]}$, $f_{IN} = 20\text{ kHz}$ $R_g = 10\text{ k}\Omega$, $R_L = \infty$	—	0.1	0.5	%
Mute On threshold voltage	MT_{ON}	$V_{IN} = 40\text{ mV[rms]}$, $R_L = 4\ \Omega$	4	—	—	V
Mute Off threshold voltage	MT_{OFF}	$V_{IN} = 40\text{ mV[rms]}$, $R_L = 4\ \Omega$	—	—	0.8	V
Maximum output power 2	P_{O2}	$V_{IN} = 1\text{ V[rms]}$, $R_L = 4\ \Omega$	—	28	—	W
Maximum output power 3	P_{O3}	$V_{CC} = 14.4\text{ V}$, THD = 10%, $R_L = 4\ \Omega$	—	21	—	W
Maximum output power 4	P_{O4}	$V_{CC} = 14.4\text{ V}$, $V_{IN} = 1\text{ V[rms]}$, $R_L = 4\ \Omega$	—	34	—	W

Note) *1 : Measurement using a bandwidth 15 Hz to 30 kHz (12 dB/OCT) filter.

*2 : Change over the standby terminal at the time shown in the right.

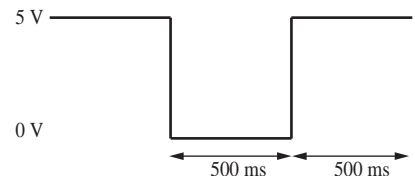

■ Technical Information

1. $P_D - T_a$ curves of HZIP025-P-0980

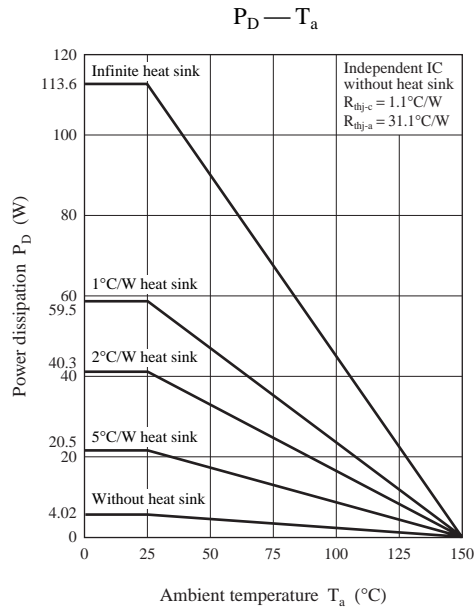

2. Main characteristics

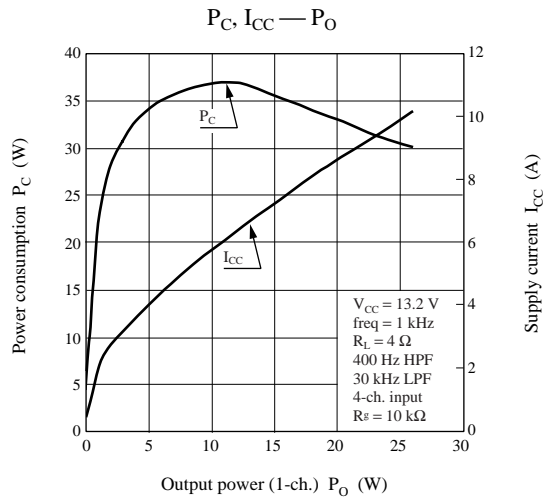
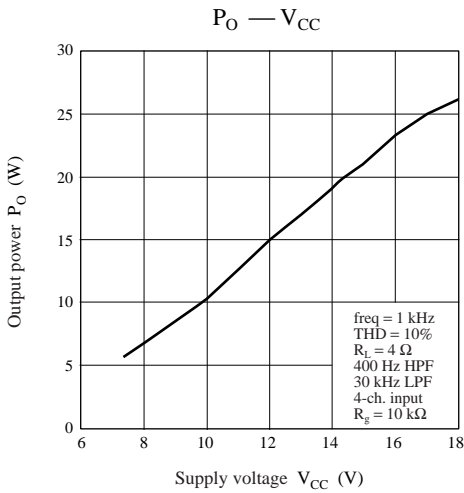

■ Technical Information (continued)

2. Main characteristics (continued)

P_O , THD — V_{IN}

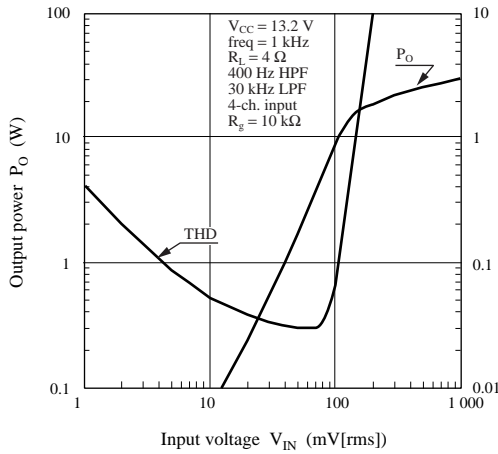

THD — V_{IN}

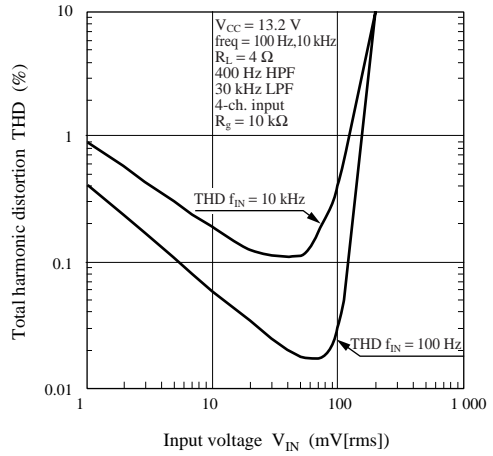

G_V , P_O — freq

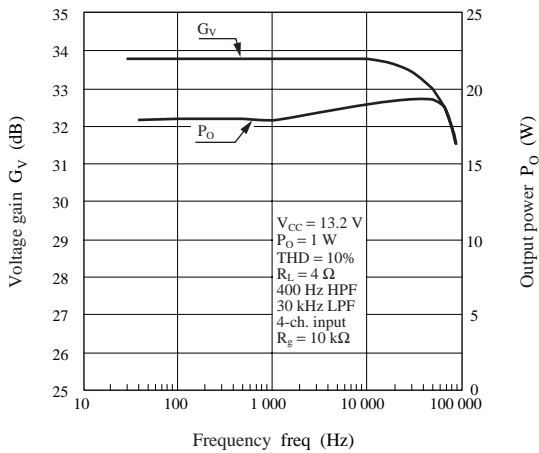

THD — freq

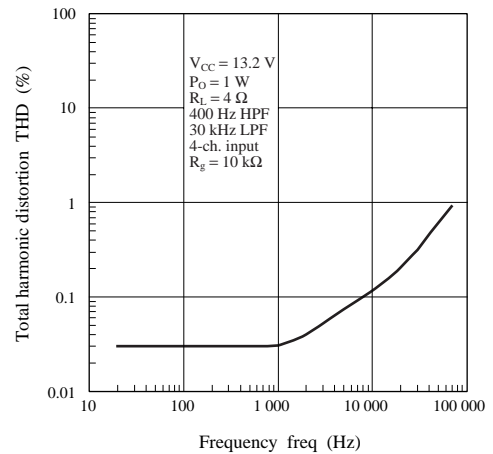

G_V , THD — V_{CC}

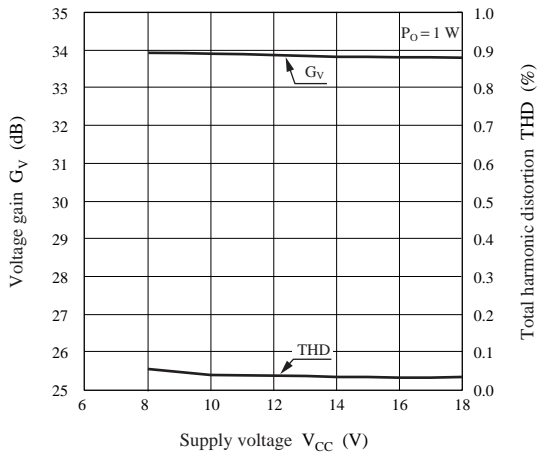

I_{CQ} , I_{STB} — V_{CC}

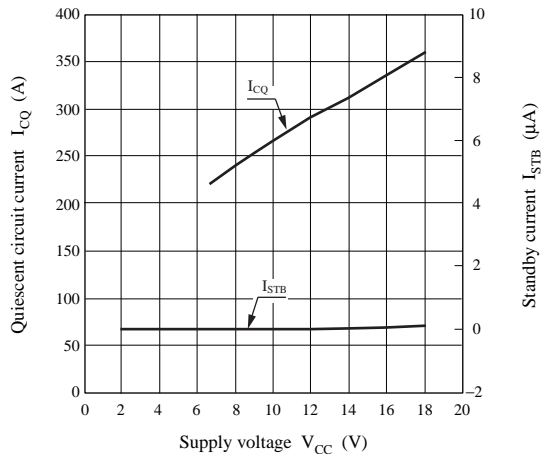

■ Technical Information (continued)

2. Main characteristics (continued)

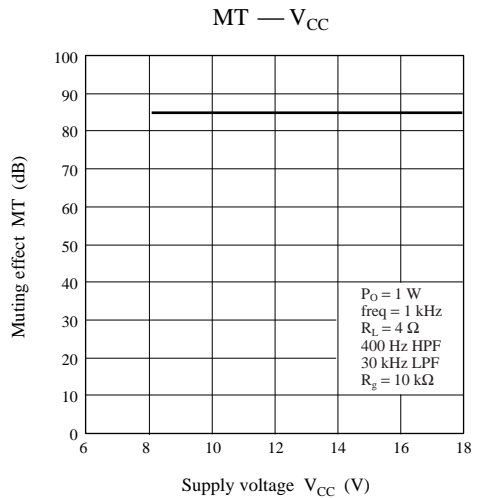
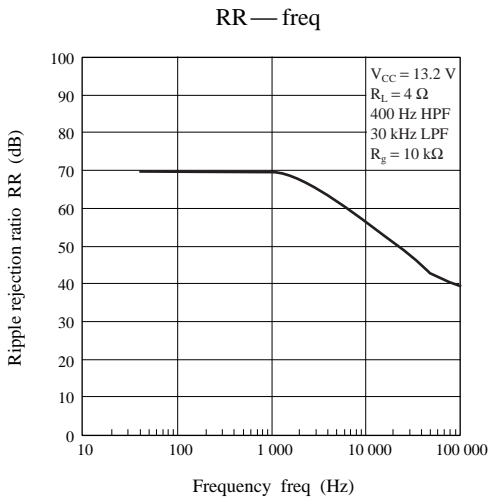
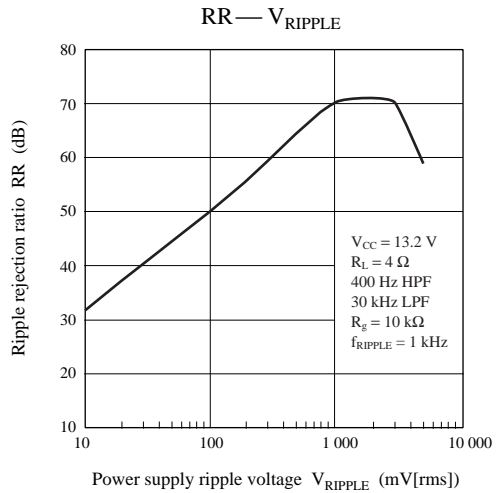
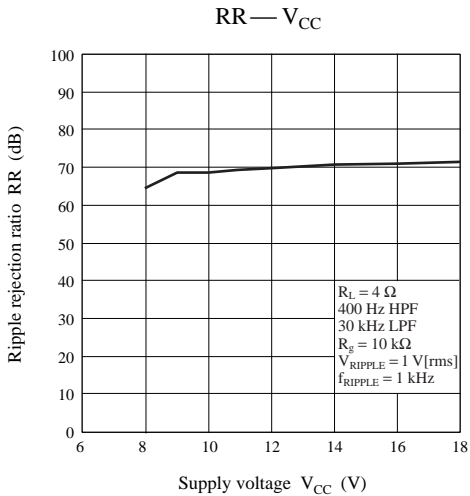
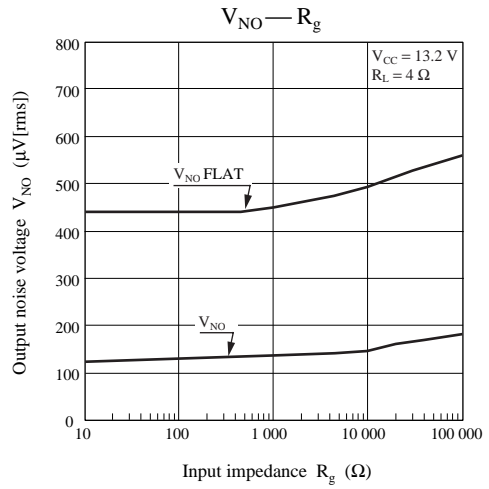
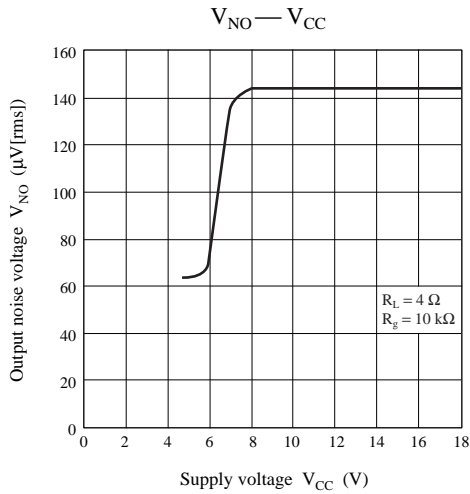

■ Technical Information (continued)

2. Main characteristics (continued)

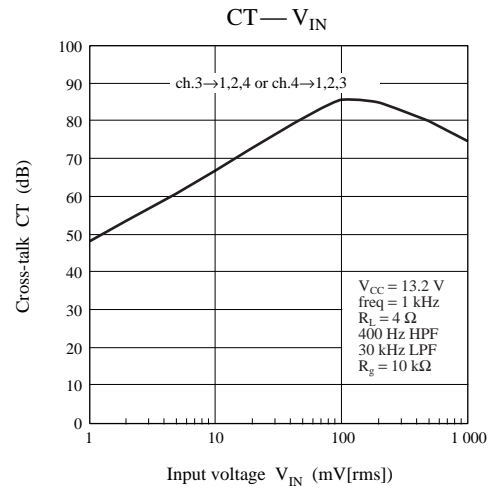
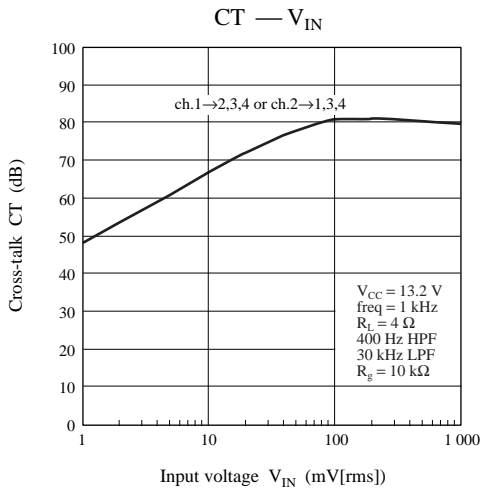
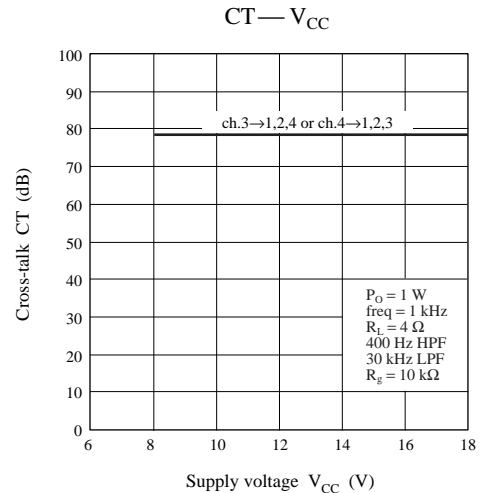
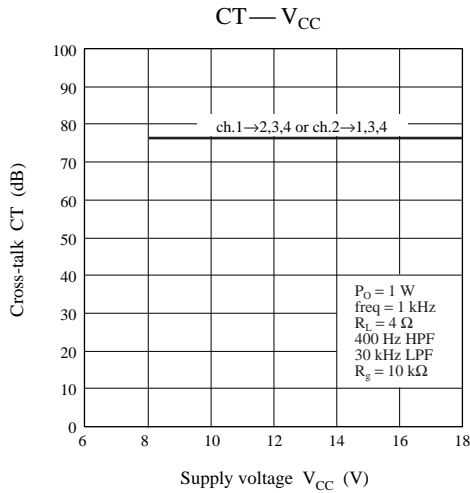
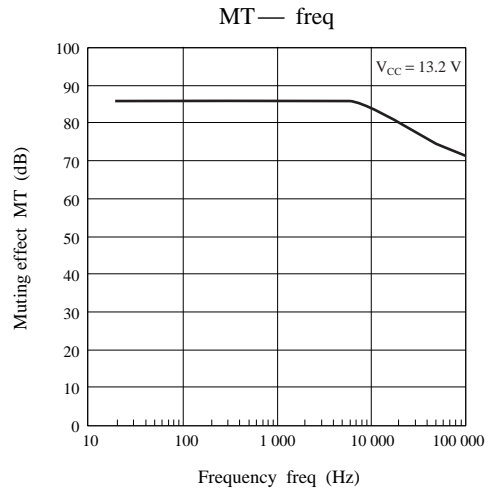
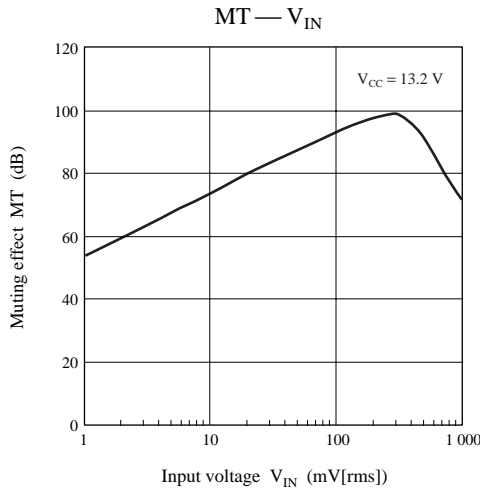

■ Technical Information (continued)

2. Main characteristics (continued)

CT — freq

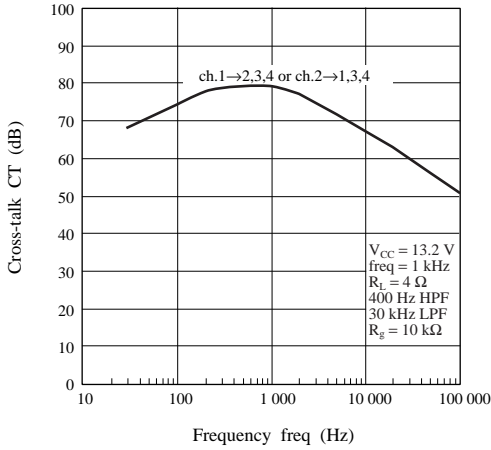

CT — freq

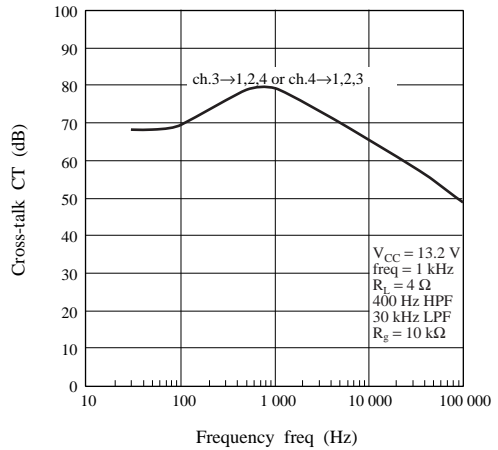

V_{OFFSET} — V_{CC}

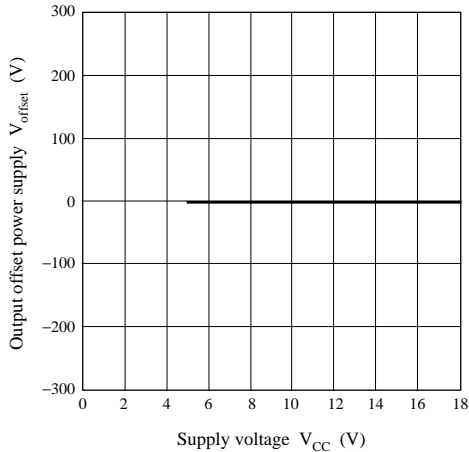

I_{CQ} — V_{STB}

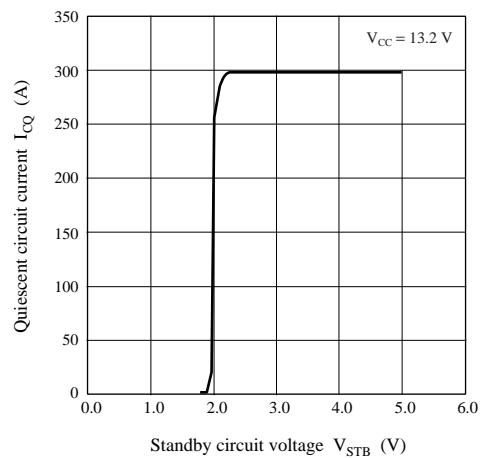

MT — V_{MUTE}

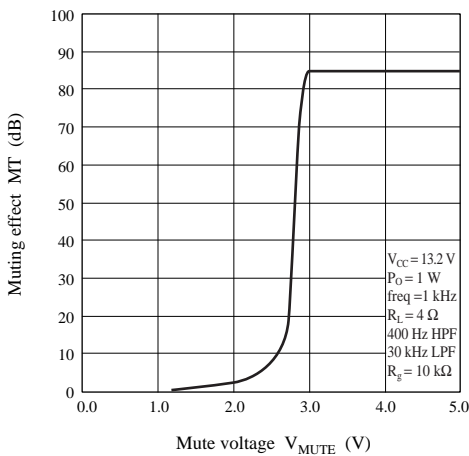

■ Technical Information (continued)

3. Printed circuit board layout example

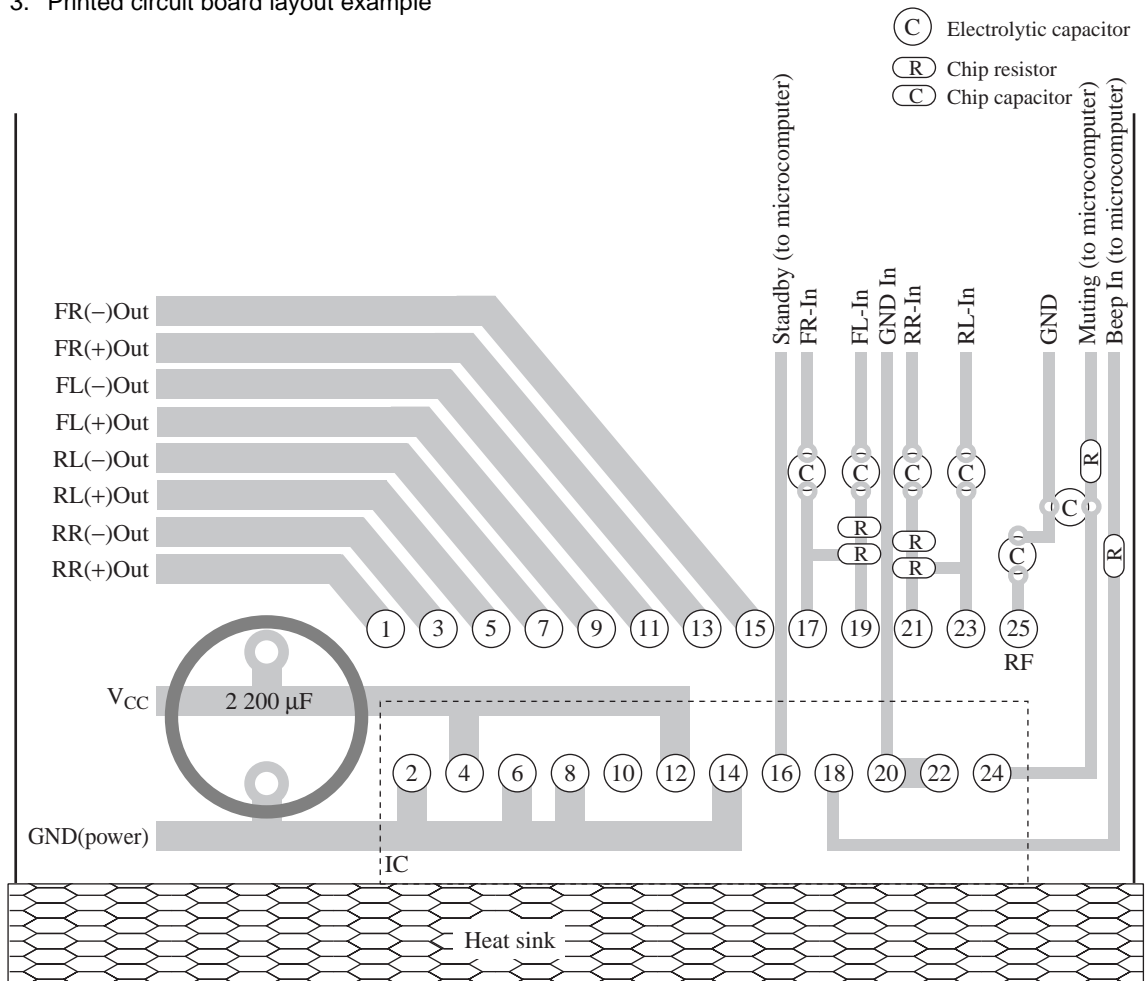

■ Application Circuit Example

