

N-Channel Enhancement Mode MOSFET

Features

- 20V/12A, $R_{DS(ON)}=35m\Omega(\text{typ.}) @ V_{GS}=10V$
 $R_{DS(ON)}=45m\Omega(\text{typ.}) @ V_{GS}=4.5V$
 $R_{DS(ON)}=110m\Omega(\text{typ.}) @ V_{GS}=2.5V$
- Super High Dense Cell Design
- High Power and Current Handling Capability
- TO-252, SOT-89 and SOT-223 Packages

Pin Description

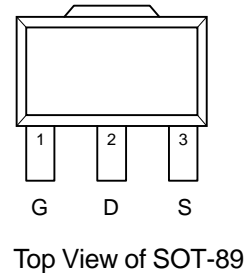
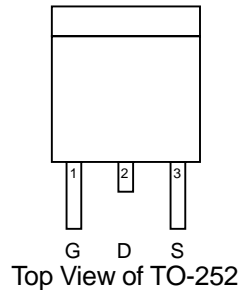

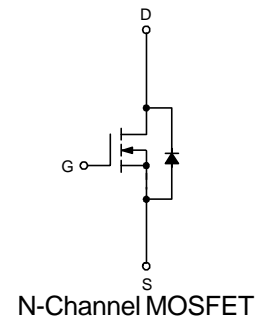
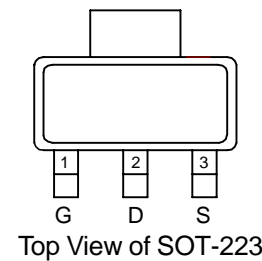

Applications

- Switching Regulators
- Switching Converters

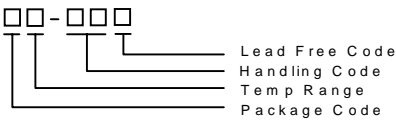

Ordering and Marking Information

<p>APM2054N □□-□□□</p>  <p>Lead Free Code Handling Code Temp Range Package Code</p>	<p>Package Code D : SOT-89 V : SOT-223 U : TO-252 Operation Junction Temp. Range C : -55 to 150 °C Handling Code o TR : Tape & Reel Lead Feed Code L : Lead Free Device Blank : Original Device</p>
<p>APM2054N D/V : APM2054N XXXXX</p>	<p>XXXXX - Date Code</p>
<p>APM2054N U :  APM2054N XXXXX</p>	<p>XXXXX - Date Code</p>

Absolute Maximum Ratings ($T_A = 25^\circ\text{C}$ unless otherwise noted)

Symbol	Parameter		Rating	Unit	
V_{DSS}	Drain-Source Voltage		20	V	
V_{GSS}	Gate-Source Voltage		± 16		
I_D^*	Maximum Drain Current – Continuous		TO-252	10	A
			SOT-223/SOT-89	4	
I_{DM}	Maximum Drain Current – Pulsed		TO-252	25	
			SOT-223/SOT-89	12	
P_D^*	Maximum Power Dissipation	$T_A=25^\circ\text{C}$	TO-252	5	W

ANPEC reserves the right to make changes to improve reliability or manufacturability without notice, and advise customers to obtain the latest version of relevant information to verify before placing orders.

Absolute Maximum Ratings ($T_A = 25^\circ\text{C}$ unless otherwise noted)

Symbol	Parameter	Rating	Unit
P_D^*	Maximum Power Dissipation	$T_A=25^\circ\text{C}$ SOT-223/SOT-89	1.25
		$T_A=100^\circ\text{C}$ TO-252	2
		$T_A=100^\circ\text{C}$ SOT-223/SOT-89	0.5
T_J	Maximum Junction Temperature	150	$^\circ\text{C}$
T_{STG}	Storage Temperature Range	-55 to 150	$^\circ\text{C}$

* Surface Mounted on FR4 Board, $t \leq 10$ sec.

Electrical Characteristics ($T_A=25^\circ\text{C}$ unless otherwise noted)

Symbol	Parameter	Test Condition	APM2054N			Unit
			Min.	Typ.	Max.	
Static						
BV_{DSS}	Drain-Source Breakdown Voltage	$V_{GS}=0V, I_{DS}=250\mu\text{A}$	20			V
I_{DSS}	Zero Gate Voltage Drain Current	$V_{DS}=16V, V_{GS}=0V$			1	μA
$V_{GS(th)}$	Gate Threshold Voltage	$V_{DS}=V_{GS}, I_{DS}=250\mu\text{A}$	0.7	0.9	1.5	V
I_{GSS}	Gate Leakage Current	$V_{GS}=\pm 16V, V_{DS}=0V$			± 100	nA
$R_{DS(ON)}$	Drain-Source On-state Resistance	$V_{GS}=10V, I_{DS}=12A$		35	40	m Ω
		$V_{GS}=4.5V, I_{DS}=6A$		45	54	
		$V_{GS}=2.5V, I_{DS}=2A$		110	130	
V_{SD}	Diode Forward Voltage	$I_{SD}=6A, V_{GS}=0V$		0.7	1.3	V
Dynamic						
Q_g	Total Gate Charge	$V_{DS}=10V, V_{GS}=4.5V, I_{DS}=6A$		11	13	nC
Q_{gs}	Gate-Source Charge			3.8		
Q_{gd}	Gate-Drain Charge			5.2		
$t_{d(ON)}$	Turn-on Delay Time	$V_{DD}=10V, I_{DS}=1A, V_{GEN}=4.5V, R_G=6\Omega$		12	24	ns
t_r	Turn-on Rise Time			10	20	
$t_{d(OFF)}$	Turn-off Delay Time			40	74	
t_f	Turn-off Fall Time			20	38	
C_{iss}	Input Capacitance	$V_{GS}=0V$		450		pF
C_{oss}	Output Capacitance	$V_{DS}=15V$		100		
C_{riss}	Reverse Transfer Capacitance	Frequency=1.0MHz		60		

Notes

^a : Pulse test ; pulse width $\leq 300\mu\text{s}$, duty cycle $\leq 2\%$

^b : Guaranteed by design, not subject to production testing

Typical Characteristics

Output Characteristics

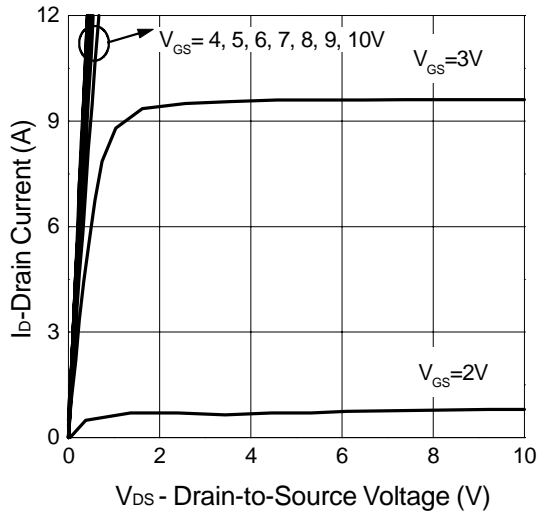

Transfer Characteristics

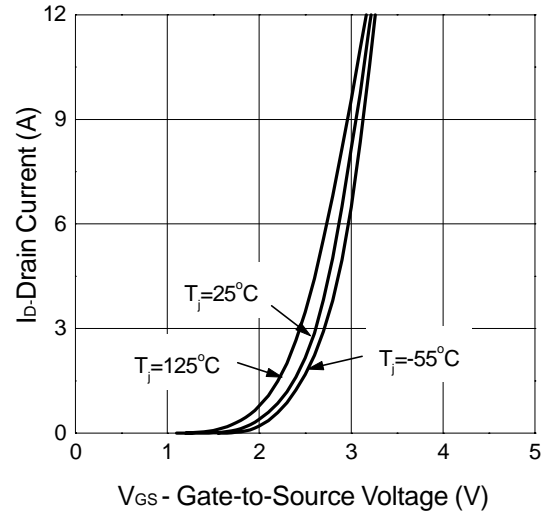

Threshold Voltage vs. Temperature

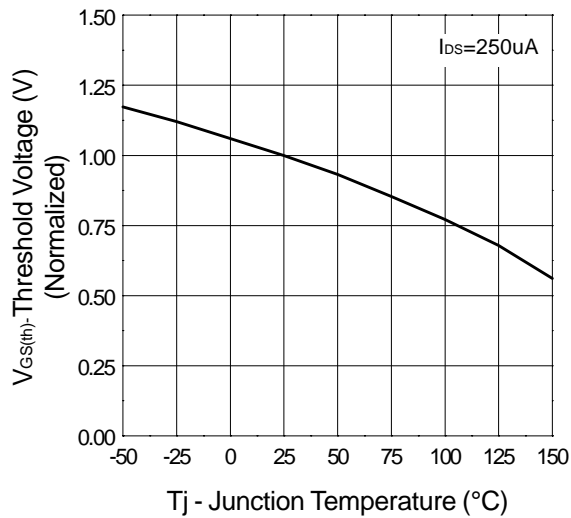

On-Resistance vs. Drain Current

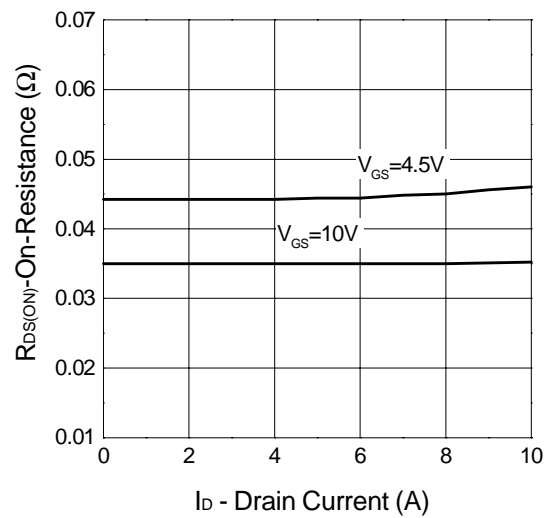

Typical Characteristics

On-Resistance vs. Gate-to-Source Voltage

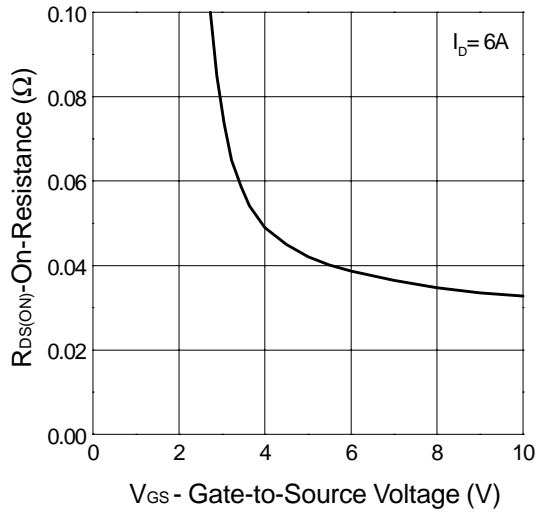

On-Resistance vs. Junction Temperature

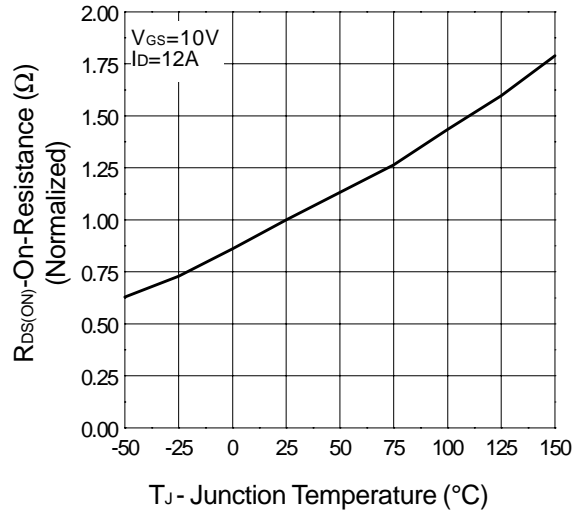

On-Resistance vs. Junction Temperature

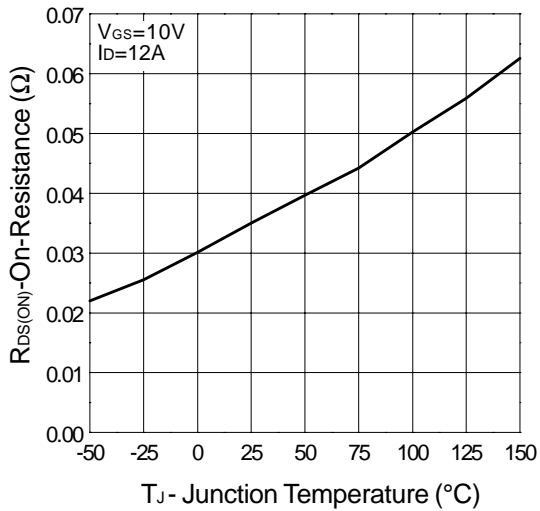

Gate Charge

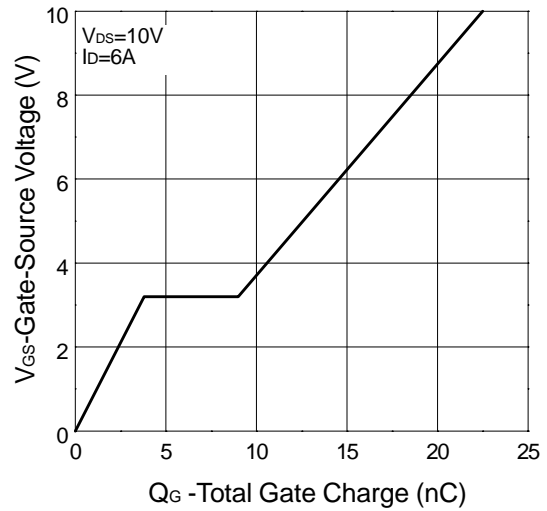

Typical Characteristics

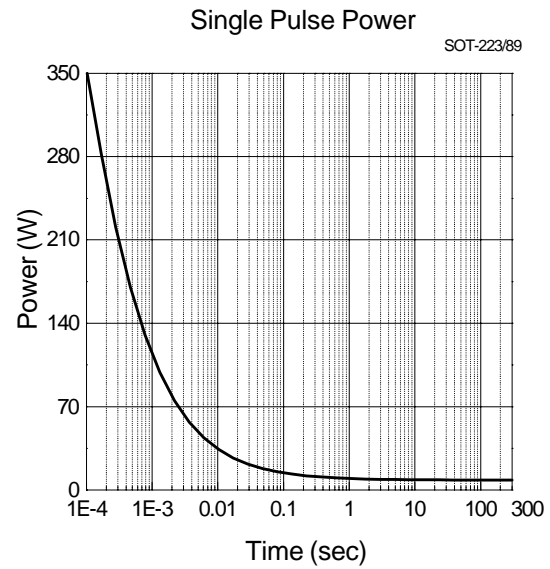
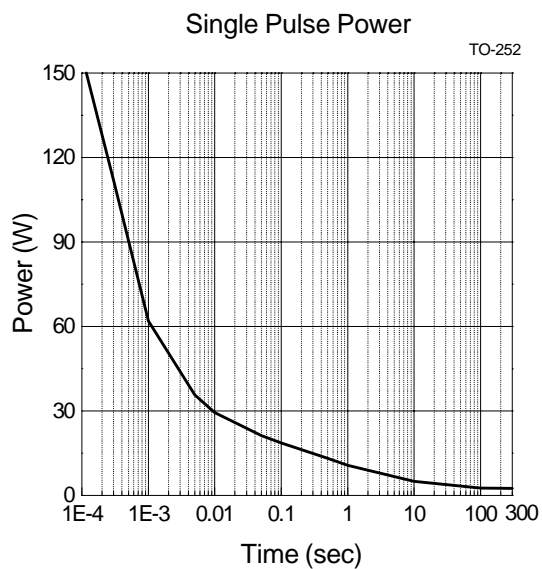
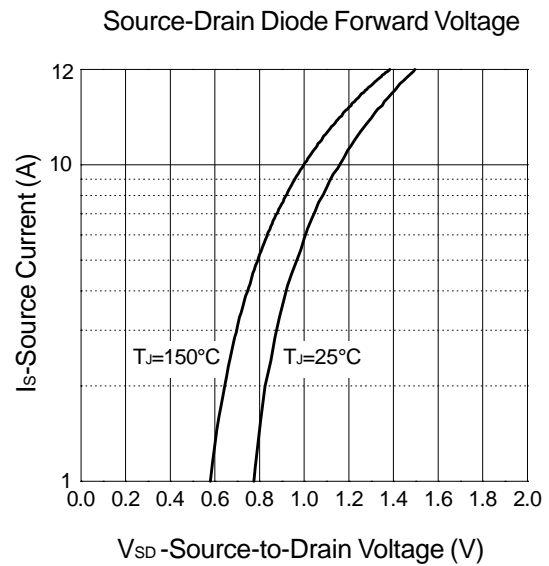
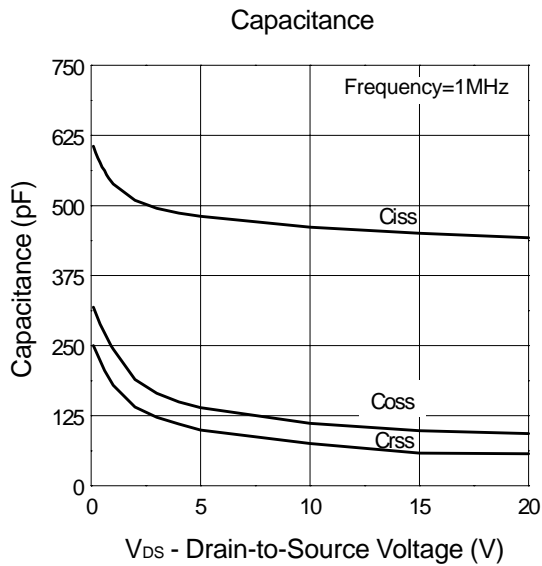

Typical Characteristics

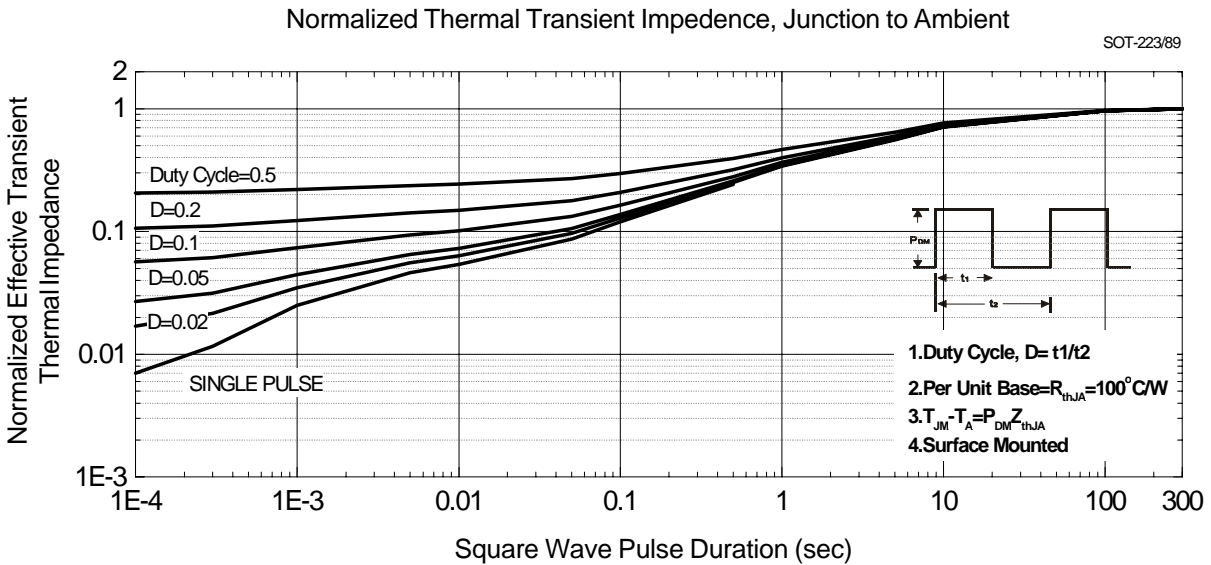
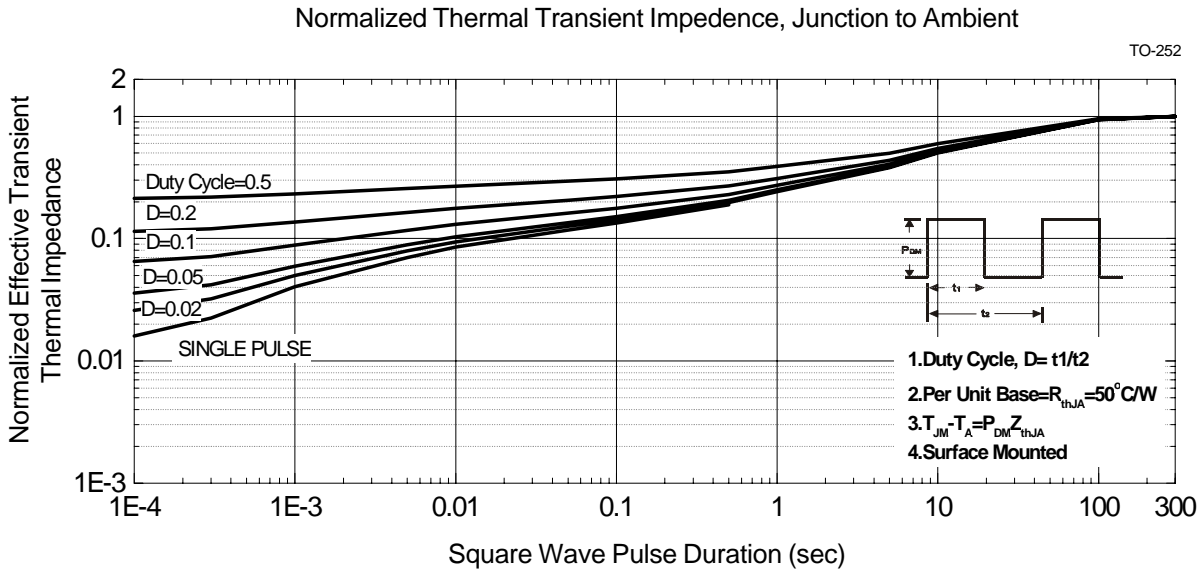

Package Information

TO-252(Reference JEDEC Registration TO-252)

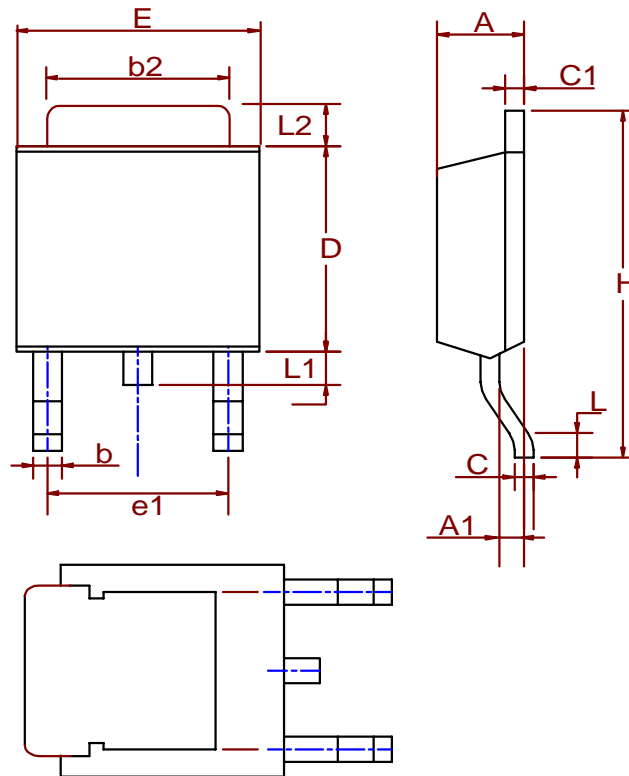

Dim	Millimeters		Inches	
	Min.	Max.	Min.	Max.
A	2.18	2.39	0.086	0.094
A1	0.89	1.27	0.035	0.050
b	0.508	0.89	0.020	0.035
b2	5.207	5.461	0.205	0.215
C	0.46	0.58	0.018	0.023
C1	0.46	0.58	0.018	0.023
D	5.334	6.22	0.210	0.245
E	6.35	6.73	0.250	0.265
e1	3.96	5.18	0.156	0.204
H	9.398	10.41	0.370	0.410
L	0.51		0.020	
L1	0.64	1.02	0.025	0.040
L2	0.89	2.032	0.035	0.080

Package Information

SOT-89 (Reference EIAJ ED-7500A Registration SC-62)

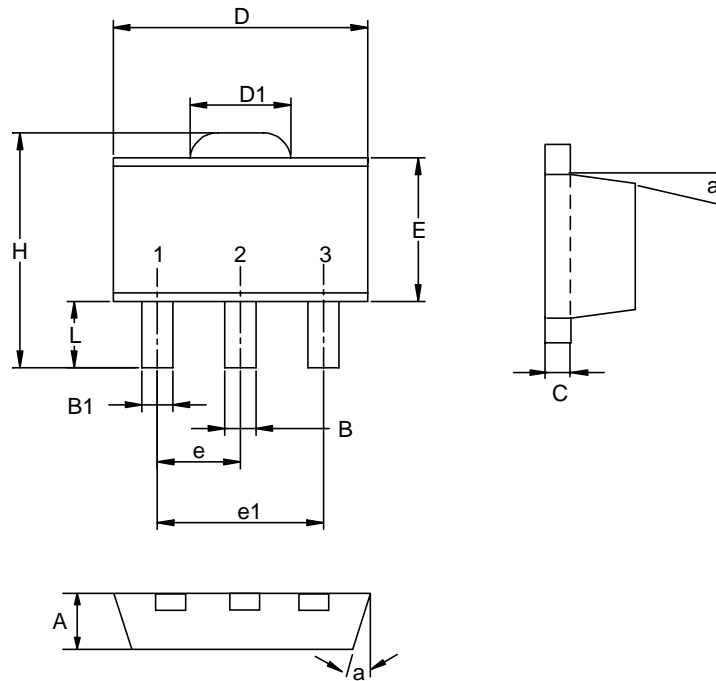

Dim	Millimeters		Inches	
	Min.	Max.	Min.	Max.
A	1.40	1.60	0.055	0.063
B	0.40	0.56	0.016	0.022
B1	0.35	0.48	0.014	0.019
C	0.35	0.44	0.014	0.017
D	4.40	4.60	0.173	0.181
D1	1.35	1.83	0.053	0.072
e	1.50 BSC		0.059 BSC	
e1	3.00 BSC		0.118 BSC	
E	2.29	2.60	0.090	0.102
H	3.75	4.25	0.148	0.167
L	0.80	1.20	0.031	0.047
α		10°		10°

Package Information

SOT-223(Reference JEDEC Registration SOT-223)

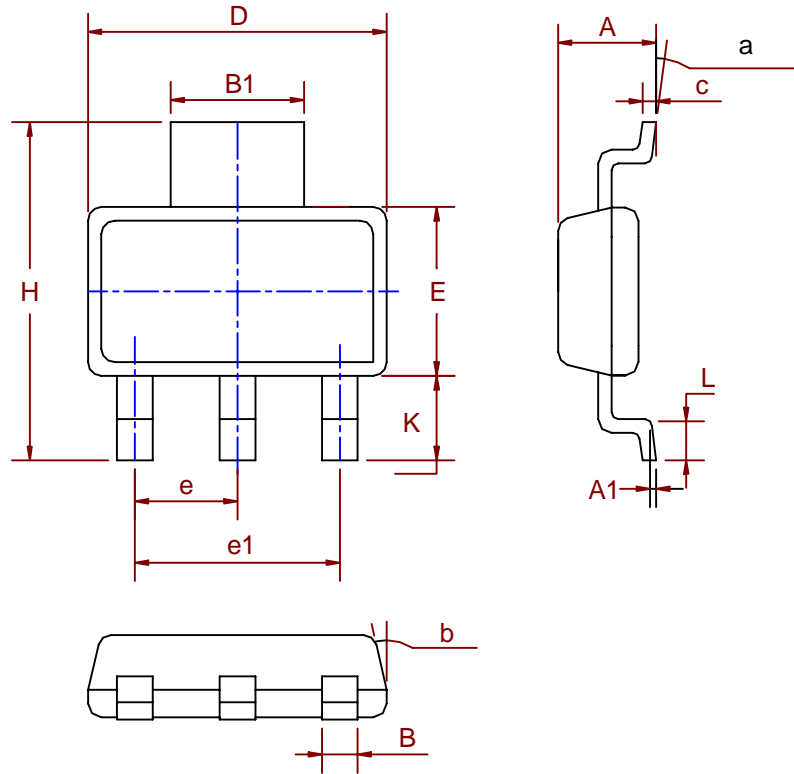

Dim	Millimeters		Inches	
	Min.	Max.	Min.	Max.
A	1.50	1.80	0.06	0.07
A1	0.02	0.08		
B	0.60	0.80	0.02	0.03
B1	2.90	3.10	0.11	0.12
c	0.28	0.32	0.01	0.01
D	6.30	6.70	0.25	0.26
E	3.30	3.70	0.13	0.15
e	2.3 BSC		0.09 BSC	
e1	4.6 BSC		0.18 BSC	
H	6.70	7.30	0.26	0.29
L	0.91	1.10	0.04	0.04
K	1.50	2.00	0.06	0.08
α	0°	10°	0°	10°
β	13°		13°	

Physical Specifications

Terminal Material	Solder-Plated Copper (Solder Material : 90/10 or 63/37 SnPb)
Lead Solderability	Meets EIA Specification RSI86-91, ANSI/J-STD-002 Category 3.

Reflow Condition (IR/Convection or VPR Reflow)

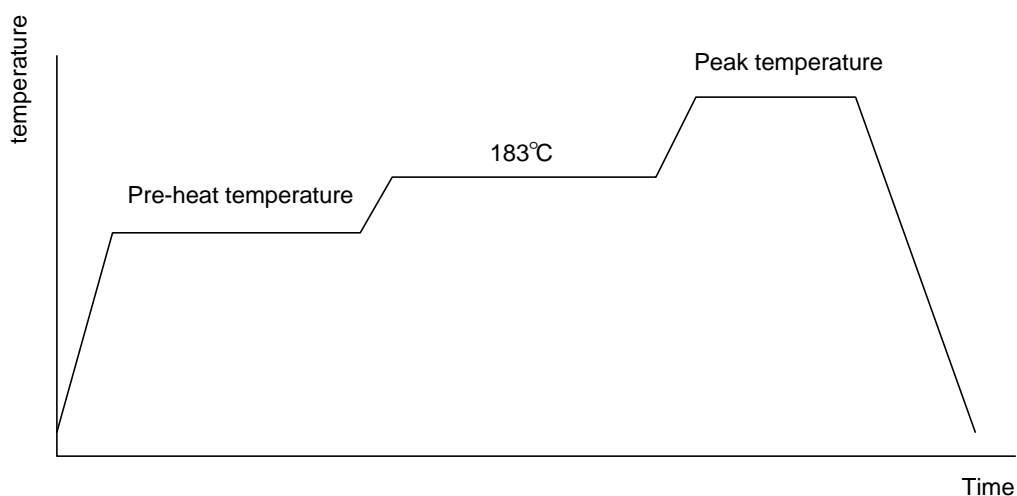

Classification Reflow Profiles

	Convection or IR/ Convection	VPR
Average ramp-up rate(183°C to Peak)	3°C/second max.	10 °C /second max.
Preheat temperature 125 ± 25°C)	120 seconds max	
Temperature maintained above 183°C	60 – 150 seconds	
Time within 5°C of actual peak temperature	10 –20 seconds	60 seconds
Peak temperature range	220 +5/-0°C or 235 +5/-0°C	215-219°C or 235 +5/-0°C
Ramp-down rate	6 °C /second max.	10 °C /second max.
Time 25°C to peak temperature	6 minutes max.	

Package Reflow Conditions

pkg. thickness ≥ 2.5mm and all bgas	pkg. thickness < 2.5mm and pkg. volume ≥ 350 mm ³	pkg. thickness < 2.5mm and pkg. volume < 350mm ³
Convection 220 +5/-0 °C		Convection 235 +5/-0 °C
VPR 215-219 °C		VPR 235 +5/-0 °C
IR/Convection 220 +5/-0 °C		IR/Convection 235 +5/-0 °C

Reflow Condition (IR/Convection or VPR Reflow)

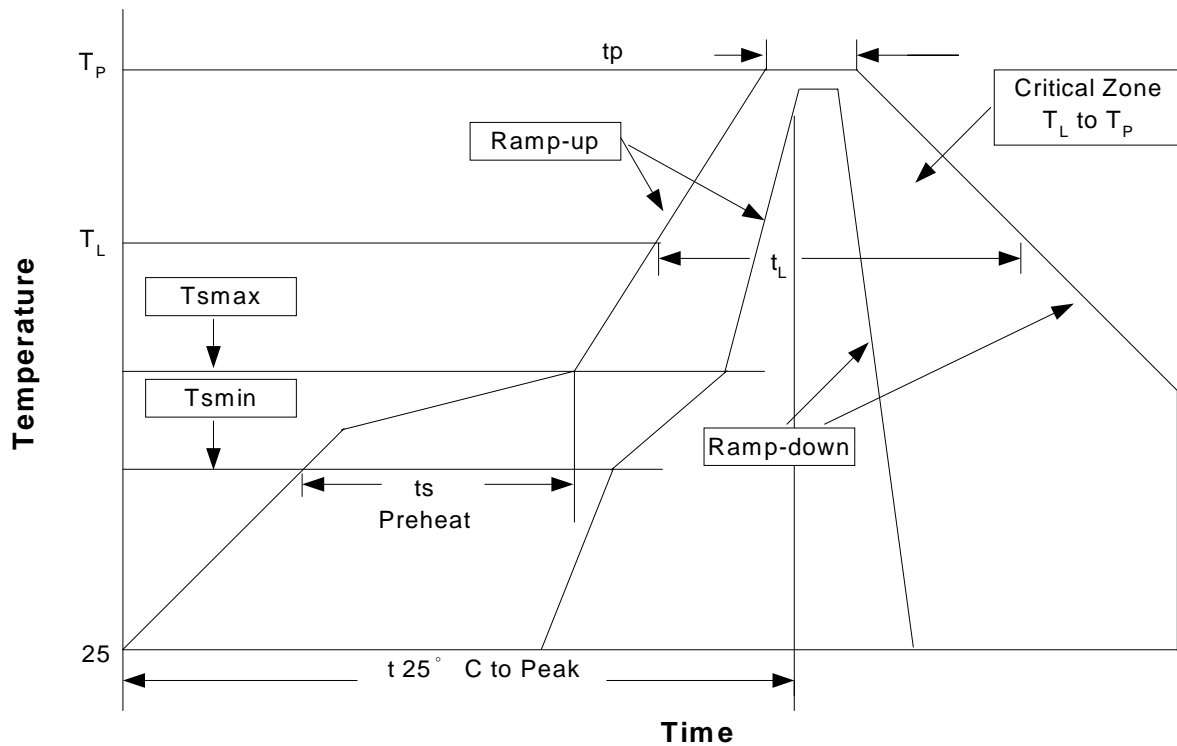

Classification Reflow Profiles

Profile Feature	Sn-Pb Eutectic Assembly		Pb-Free Assembly	
	Large Body	Small Body	Large Body	Small Body
Average ramp-up rate (T _L to T _P)	3°C/second max.		3°C/second max.	
Preheat - Temperature Min (T _{min}) - Temperature Mix (T _{max}) - Time (min to max)(t _s)	100°C 150°C 60-120 seconds		150°C 200°C 60-180 seconds	
T _{max} to T _L - Temperature(T _L) - Time (t _L)			3°C/second max	
Peak Temperature(T _p)	183°C 60-150 seconds		217°C 60-150 seconds	
Time within 5°C of actual Peak Temperature(t _p)	225 +0/-5°C	240 +0/-5°C	245 +0/-5°C	250 +0/-5°C
Ramp-down Rate	10-30 seconds	10-30 seconds	10-30 seconds	20-40 seconds
Time 25°C to Peak Temperature	6°C/second max. 6 minutes max.		6°C/second max. 8 minutes max.	

Note: All temperatures refer to topside of the package. Measured on the body surface.

Reliability test program

Test item	Method	Description
SOLDERABILITY	MIL-STD-883D-2003	245°C, 5 SEC
HOLT	MIL-STD 883D-1005.7	1000 Hrs Bias @ 125°C
PCT	JESD-22-B, A102	168 Hrs, 100% RH, 121°C
TST	MIL-STD 883D-1011.9	-65°C ~ 150°C, 200 Cycles

Carrier Tape & Reel Dimensions

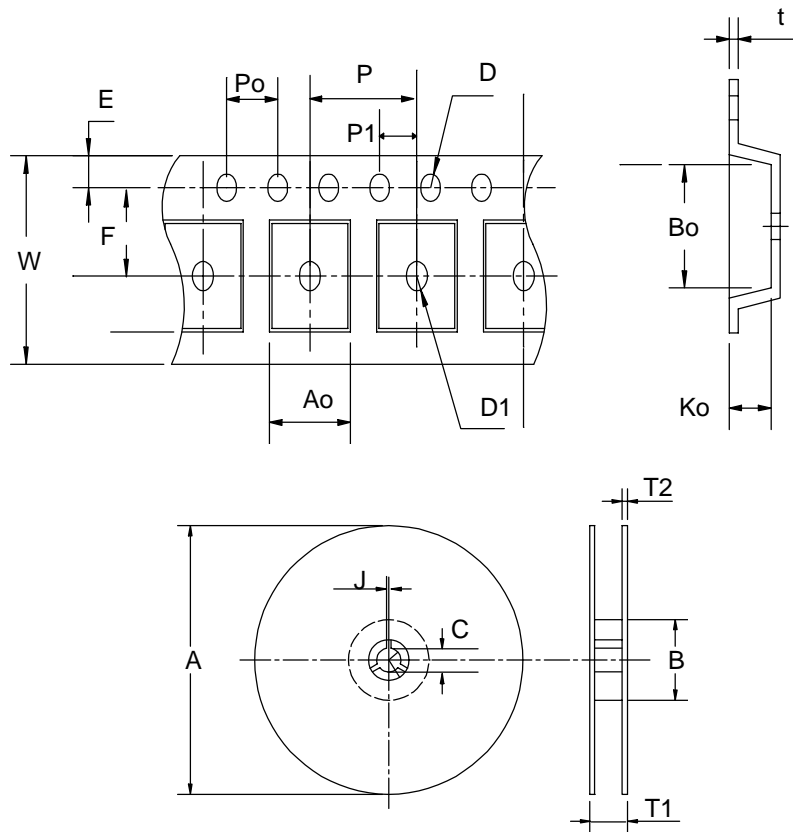

Application	A	B	C	J	T1	T2	W	P	E
TO-252	330±3	100±2	13±0.5	2±0.5	16.4 +0.3 -0.2	2.5±0.5	16+0.3 -0.1	8±0.1	1.75±0.1
	F	D	D1	Po	P1	Ao	Bo	Ko	t
	7.5±0.1	1.5±0.1	1.5±0.25	4.0±0.1	2.0±0.1	6.8±0.1	10.4±0.1	2.5±0.1	0.3±0.05
Application	A	B	C	J	T1	T2	W	P	E
SOT-89	178±1	70±2	13.5±0.15	3±0.15	14±2	1.3±0.3	12+0.3 12-0.1	8±0.1	1.75±0.1
	F	D	D1	Po	P1	Ao	Bo	Ko	t
	5.5±0.05	1.5±0.1	1.5±0.1	4.0±0.1	2.0±0.1	4.8±0.1	4.5±0.1	1.80±0.1	0.3±0.013
Application	A	B	C	J	T1	T2	W	P	E
SOT-223	330±1	62±1.5	12.75± 0.15	2±0.6	12.4+0.2	2±0.2	12±0.3	8±0.1	1.75±0.1
	F	D	D1	Po	P1	Ao	Bo	Ko	t
	5.5±0.05	1.5±0.1	1.5±0.1	4.0±0.1	2.0±0.05	6.9±0.1	7.5±0.1	2.1±0.1	0.3±0.05

Cover Tape Dimensions

Application	Carrier Width	Cover Tape Width	Devices Per Reel
SOT- 89	12	9.3	1000
SOT- 223	12	9.3	2500
TO- 252	16	13.3	2500

Customer Service

Anpec Electronics Corp.

Head Office :

5F, No. 2 Li-Hsin Road, SBIP,

Hsin-Chu, Taiwan, R.O.C.

Tel : 886-3-5642000

Fax : 886-3-5642050

Taipei Branch :

7F, No. 137, Lane 235, Pac Chiao Rd.,

Hsin Tien City, Taipei Hsien, Taiwan, R. O. C.

Tel : 886-2-89191368

Fax : 886-2-89191369