

REVISIONS		
ISS	ZONE	DESCRIPTION\PER REQUEST\DATE

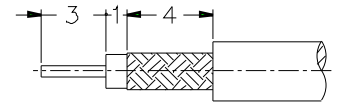

RECOMMENDED
CABLE STRIPPING DIM'S

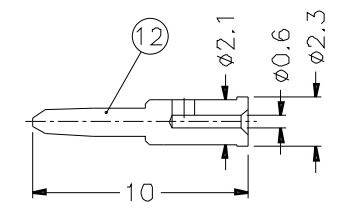
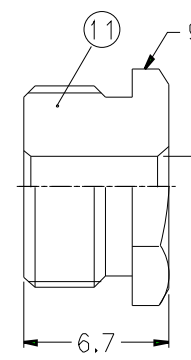
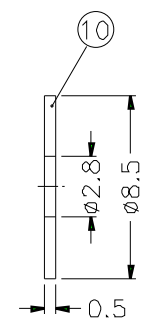
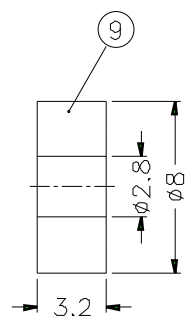
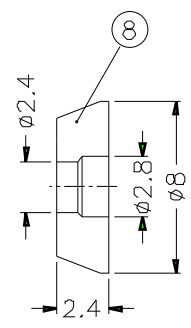
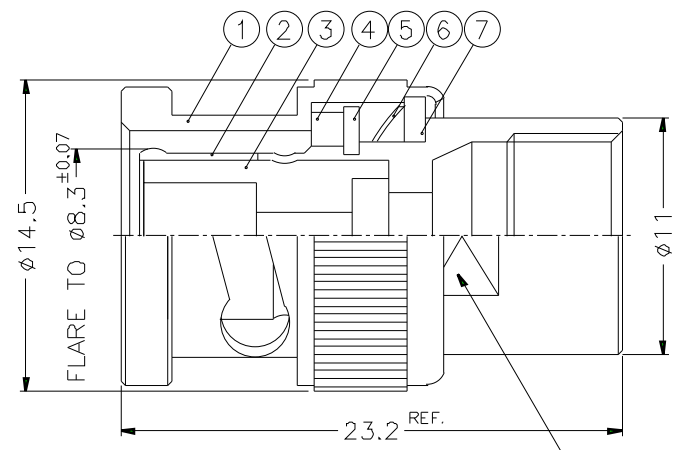

NOTES: FINISH (PLATING THICKNESS IN MICRO-INCHES)
 1. BRASS PER QQ-B-626
 2. BRASS PER QQ-B-613
 3. NICKEL PL. 100 MIN. THICK OVER COPPER STRIKE
 4. NICKEL PL. 200 MIN. THICK OVER COPPER STRIKE
 5. GOLD PL. 3 MIN. THICK OVER NICKEL PL. 100 MIN. THICK OVER COPPER STRIKE
 6. TEFLON MIL-P-1946B
 9.5 ON FLATS

1. CRIMPED CONTACT PIN
HEX CRIMP SIZE .068"

12	CONTACT PIN	NOTE 1	NOTE 5	1	B3000-8-23/06
11	HEX NUT	NOTE 1	NOTE 3	1	B5205-12-95/28
10	WASHER	NOTE 2	NOTE 3	1	WS-85/28X05
9	GASKET	SILICONE	RED	1	GS-8/28X32
8	TOP HAT	NOTE 1	NOTE 3	1	B5205-9-28/24-B
7	WASHER	NOTE 2	NOTE 3	1	WS-128/9X08
6	SPRING	SK5	NOTE 4	1	B50000-6
5	RETAINER RING	NOTE 1	NOTE 3	1	B50000-5
4	GASKET	RUBBER	RED	1	GS-115/8X15
3	INSULATOR	NOTE 6	NATURAL	1	ATC B-3000-3T-50
2	BODY	NOTE 1	NOTE 3	1	B5205-2
1	SHELL	NOTE 1	NOTE 3	1	B50000-1-B
NO.	DESCRIPTION	MATERIAL	FINISH	Q'TY	DRAWING NO.

DIMENSIONS ARE IN MILLIMETERS
 UNLESS OTHERWISE SPECIFIED
 TOLERANCES
 0.5-6 = ± 0.2
 6-30 = ± 0.4
 30-120 = ± 0.6
 120-315 = ± 1
 315-1000 = ± 1.6
 1000-2000 = ± 2.4

PART NO.	B1141C1-NT3G-5-50	
APPROVED	DATE	10-11-01'
CHECKED	DATE	10-11-01'
DRAWN	DATE	10-11-01'
SCALE	3/1	ISSUE A
FILE NO.		

Amphenol

TITLE BNC CLAMP PLUG
(FOR RG-174/U,188A/U,316/U)

DRAWING NO. KJ-B1141C1-NT3G-316U-50

ITEM NO.