



Aluminum electrolytic capacitors

Capacitors with screw terminals

Series/Type: B43455, B43457

Date: October 2007

Long-life grade capacitors

Applications

- Frequency converters
- Uninterruptible power supplies
- Professional power supplies

Features

- Long useful life
- All-welded construction ensures reliable electrical contact
- Version with optimized construction for base cooling (heat sink mounting) available
- Version with low-inductance design available
- Self-extinguishing electrolyte

Construction

- Charge-discharge proof, polar
- Aluminum case with insulating sleeve
- Poles with screw terminal connections
- Mounting with ring clips, clamps or threaded stud
- The bases of types with threaded stud and $d \leq 76.9$ mm are not insulated, types with $d = 91$ mm have fully insulated bases

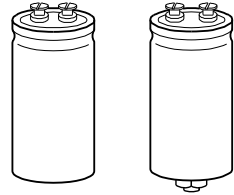

B43455

B43457

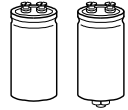

Specifications and characteristics in brief

Rated voltage V_R	350 ... 450 V DC		
Surge voltage V_S	$1.10 \cdot V_R$		
Rated capacitance C_R	1000 ... 15000 μF		
Capacitance tolerance	$\pm 20\% \triangle M$		
Leakage current I_{leak} (20 °C, 5 min)	$I_{\text{leak}} \leq 0.3 \mu\text{A} \cdot \left(\frac{C_R}{\mu\text{F}} \cdot \frac{V_R}{\text{V}} \right)^{0.7} + 4 \mu\text{A}$		
Self-inductance ESL	d = 51.6 mm: approx. 15 nH d \geq 64.3 mm: approx. 20 nH Capacitors with low-inductance design: d \geq 64.3 mm: approx. 13 nH		
Useful life		Requirements:	
85 °C; V_R ; $I_{AC,R}$	> 10000 h	$\Delta C/C$	$\leq \pm 30\%$ of initial value
40 °C; V_R ; $1.5 \cdot I_{AC,R}$	> 200000 h	ESR	≤ 3 times initial specified limit
		I_{leak}	\leq initial specified limit
Voltage endurance test		Post test requirements:	
85 °C; V_R	2 000 h	$\Delta C/C$	$\leq \pm 10\%$ of initial value
		ESR	≤ 1.3 times initial specified limit
		I_{leak}	\leq initial specified limit
Vibration resistance test	To IEC 60068-2-6, test Fc: Displacement amplitude 0.75 mm, frequency range 10 ... 55 Hz, acceleration max. 10 g, duration 3 \times 2 h. Capacitor mounted by its body which is rigidly clamped to the work surface.		
Characteristics at low temperature	Impedance ratio: $Z_{-40^\circ\text{C}}/Z_{+20^\circ\text{C}}$ (100Hz) ≤ 16 (at $V_R = 350$ V DC) ≤ 12 (at $V_R \geq 400$ V DC)		
IEC climatic category	To IEC 60068-1: 25/085/56 (–25 °C/+85 °C/56 days damp heat test) The capacitors can be operated in the temperature range of –40 °C to +85 °C but the impedance at –40 °C should be taken into consideration.		
Detail specification	Similar to CECC 30301-803, CECC 30301-807		
Sectional specification	IEC 60384-4		

Ripple current capability

Due to the ripple current capability of the contact elements, the following current upper limits must not be exceeded:

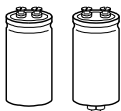
Capacitor diameter	51.6 mm	64.3 mm	76.9 mm	91 mm
$I_{AC,max}$	34 A	45 A	57 A	80 A



B43455, B43457

Long useful life – 85 °C

Dimensional drawings

B43455

Ring clip/clamp mounting

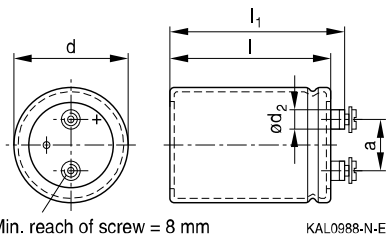

B43457

Threaded stud mounting

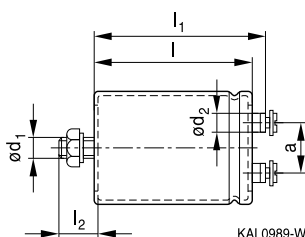

M5: Min. reach of screw = 8 mm
M6: Min. reach of screw = 12 mm^{*)}
^{*)} 9.5 mm for low-inductance design

Positive pole marking: +

The base of types with threaded stud and $d = 91$ mm is fully insulated (the lengths l and l_1 are increased by 0.5 mm in these cases). For types with threaded stud and $d \leq 76$ mm the base is not insulated. Also refer to the mounting instructions in chapter "Capacitors with screw terminals – Accessories".

Dimensions and weights

Terminal	Dimensions (mm) with insulating sleeve							Approx. weight (g)
	d	$l \pm 1$	$l_1 \pm 1$	$l_2 +0/-1$	d_1	d_2 max.	$a +0.2/-0.4$	
M5	51.6 +0/-0.8	80.7	87.2	17	M12	10.2	22.2	220
M5	51.6 +0/-0.8	105.7	112.2	17	M12	10.2	22.2	280
M5	64.3 +0/-0.8	80.7	87.2	17	M12	13.2	28.5	370
M5	64.3 +0/-0.8	105.7	112.2	17	M12	13.2	28.5	440
M5	64.3 +0/-0.8	143.2	149.7	17	M12	13.2	28.5	630
M6	76.9 +0/-0.7	105.7	111.5	17	M12	17.7	31.7	620
M6	76.9 +0/-0.7	143.2	149.0	17	M12	17.7	31.7	840
M6	76.9 +0/-0.7	168.7	174.5	17	M12	17.7	31.7	1000
M6	76.9 +0/-0.7	220.7	226.5	17	M12	17.7	31.7	1300
M6	91.0 +0/-2	144.5	149.8	17	M12	17.7	31.7	1200
M6	91.0 +0/-2	221.0	226.3	17	M12	17.7	31.7	1900

Dimensions are also valid for low-inductance design.



Packing

Capacitor diameter d	Packing units (pcs.)	Capacitor diameter d	Packing units (pcs.)
51.6 mm	22	76.9 mm	12
64.3 mm	15	91.0 mm	8

For ecological reasons the packing is pure cardboard.

Special designs

- Low-inductance design
- For heat sink mounting

Design for optimal connection of capacitors to the heat sink when using base cooling with the following features (refer to chapter "General technical information, 5.2 Cooling"):

- Electrical insulation of the capacitors base with 2 overlapping thermal pads for optimal heat flow (minimal thermal resistance at the capacitor base)
- Minimal overall length tolerance (± 0.35 mm) for mounting between heat sink and bus bar
- Case with extra groove near the base for clamp mounting (recommended ring clamp B44030A0165B ... A0190B)

This version is available only for capacitors without threaded stud and for diameters ≥ 64.3 mm. Regarding ripple current and useful life, please refer to column $I_{AC,R}(B)$ in the table "Technical data and ordering codes" and in the useful life curves.

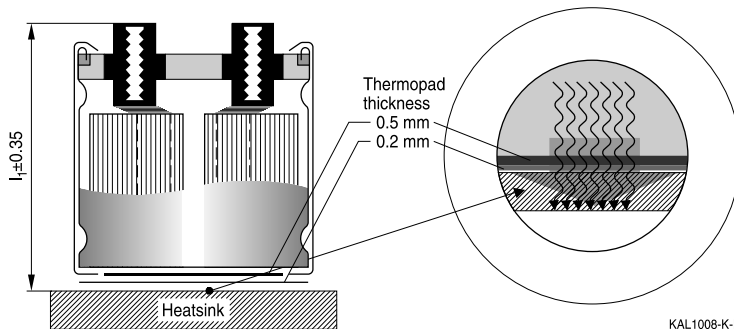

KAL1008-K-E

Ordering codes:

Design	Identification in 3rd block of ordering code	Remark
Low inductance (13 nH)	M003	For capacitors with diameter $d \geq 64.3$ mm
For heat sink mounting	M007	For capacitors with diameter $d \geq 64.3$ mm and without threaded stud

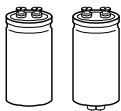
B43455, B43457
Long useful life – 85 °C

Dimensions and weights for heat sink mounting:

Terminal	Dimensions (mm) with insulating sleeve							Min. reach of screw mm	Approx. weight g
	d	l ±1	l ₁ ±0.35	l ₂ +0/-1	d ₁	d ₂ max.	a +0.2/-0.4		
M5	64.3 +0/-0.8	80.7	86.3	17	M12	13.2	28.5	7.3	370
M5	64.3 +0/-0.8	105.7	111.3	17	M12	13.2	28.5	7.3	440
M6	76.9 +0/-0.7	105.7	110.6	17	M12	17.7	31.7	9.7	620
M6	76.9 +0/-0.7	143.2	148.1	17	M12	17.7	31.7	9.7	840
M6	91.0 +0/-2	97.0	101.4	17	M12	17.7	31.7	9.7	1000
M6	91.0 +0/-2	144.5	148.9	17	M12	17.7	31.7	9.7	1200

Dimensions for other sizes are available upon request.

Accessories

The following items are included in the delivery package, but are not fastened to the capacitors:

	Thread	Toothed washers	Screws/nuts	Maximum torque
For terminals	M5	A 5.1 DIN 6797	Cylinder-head screw M5 × 8 DIN 84-4.8	2 Nm
	M6	A 6.4 DIN 6797	Cylinder-head screw M6 × 12 DIN 85-4.8	2.5 Nm
For mounting	M8	J 8.2 DIN 6797	Hex nut BM 8 DIN 439	4 Nm
	M12	J 12.5 DIN 6797	Hex nut BM 12 DIN 439	10 Nm

The following items must be ordered separately. For details, refer to chapter "Capacitors with screw terminals – Accessories".

Item	Type
Ring clips	B44030
Clamps for capacitors with d ≥ 64.3 mm	B44030
Insulating parts	B44020

Overview of available types

V_R (V DC)	350	400	450
	Case dimensions $d \times l$ (mm)		
C_R (μF)			
1000			51.6 × 80.7
1500	51.6 × 80.7	51.6 × 80.7	51.6 × 105.7 64.3 × 80.7
2200	51.6 × 105.7	51.6 × 105.7 64.3 × 80.7	64.3 × 105.7
3300	64.3 × 105.7	64.3 × 105.7	64.3 × 143.2 76.9 × 105.7
4700	64.3 × 143.2 76.9 × 105.7	76.9 × 105.7	76.9 × 143.2
5600	76.9 × 105.7	76.9 × 143.2	76.9 × 168.7
6800	76.9 × 143.2	76.9 × 143.2	76.9 × 220.7
8200	76.9 × 168.7	91.0 × 144.5	76.9 × 220.7
10000	76.9 × 220.7	76.9 × 220.7	91.0 × 221.0
12000	76.9 × 220.7	91.0 × 221.0	
15000	91.0 × 221.0		

The capacitance and voltage ratings listed above are available in different cases upon request.

Other voltage and capacitance ratings are also available upon request.

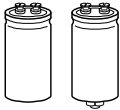

B43455, B43457

Long useful life – 85 °C

Technical data and ordering codes

C_R	Case dimensions	ESR _{typ} 100 Hz	ESR _{max} 100 Hz	Z _{max} 10 kHz	I _{AC,max} 100 Hz	I _{AC,R} 100 Hz	I _{AC,R(B)} 100 Hz	Ordering code (composition see below)
100 Hz	d × l	20 °C	20 °C	20 °C	40 °C	85 °C	85 °C	
μF	mm	mΩ	mΩ	mΩ	A	A	A	

V_R = 350 V DC

1500	51.6 × 80.7	80	120	96	14	4.9	9.4	B4345*C4158M000
2200	51.6 × 105.7	48	72	58	20	7.1	12.7	B4345*D4228M000
3300	64.3 × 105.7	32	48	38	22	8.1	14.2	B4345*C4338M00#
4700	64.3 × 143.2	25	38	30	27	9.9	15.1	B4345*C4478M00#
4700	76.9 × 105.7	25	38	30	28	10.2	19.7	B4345*B4478M00#
5600	76.9 × 105.7	21	32	25	31	11.3	22.4	B4345*A4568M00#
6800	76.9 × 143.2	18	27	22	35	12.8	21.4	B4345*A4688M00#
8200	76.9 × 168.7	15	23	18	42	15.4	23.7	B4345*B4828M00#
10000	76.9 × 220.7	10	15	12	55	19.8	27.5	B4345*C4109M00#
12000	76.9 × 220.7	9.0	14	11	57	22.5	31.7	B4345*B4129M00#
15000	91.0 × 221.0	7.0	11	8.0	73	26.5	39.2	B4345*A4159M00#

V_R = 400 V DC

1500	51.6 × 80.7	69	104	83	15	5.4	10.9	B4345*D9158M000
2200	51.6 × 105.7	59	89	71	18	6.5	11.6	B4345*B9228M000
2200	64.3 × 80.7	59	89	71	18	6.4	12.3	B4345*C9228M00#
3300	64.3 × 105.7	36	54	43	25	9.0	15.9	B4345*A9338M00#
4700	76.9 × 105.7	27	41	32	27	9.9	19.3	B4345*A9478M00#
5600	76.9 × 143.2	22	33	26	31	11.4	18.8	B4345*A9568M00#
6800	76.9 × 143.2	20	30	24	35	12.6	21.9	B4345*A9688M00#
8200	91.0 × 144.5	17	26	20	40	14.5	24.6	B4345*A9828M00#
10000	76.9 × 220.7	15	23	18	47	17.1	23.8	B4345*A9109M00#
12000	91.0 × 221.0	12	18	14	54	19.6	28.5	B4345*A9129M00#

Composition of ordering code

* = Mounting style

5 = for capacitors with ring clip/clamp mounting

7 = for capacitors with threaded stud

= Design

0 = for capacitors with standard inductance

3 = for capacitors with low inductance (13 nH) - only capacitors with diameter d ≥ 64.3 mm

7 = for heat sink mounting - only capacitors with diameter d ≥ 64.3 mm and without threaded stud

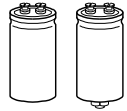
Technical data and ordering codes

C_R 100 Hz 20 °C μF	Case dimensions $d \times l$ mm	ESR_{typ} 100 Hz 20 °C m Ω	ESR_{max} 100 Hz 20 °C m Ω	Z_{max} 10 kHz 20 °C m Ω	$I_{\text{AC,max}}$ 100 Hz 40 °C A	$I_{\text{AC,R}}$ 100 Hz 85 °C A	$I_{\text{AC,R(B)}}$ 100 Hz 85 °C A	Ordering code (composition see below)
$V_R = 450 \text{ V DC}$								
1000	51.6 × 80.7	99	149	119	12	4.5	8.6	B4345*D5108M000
1500	51.6 × 105.7	63	95	76	17	6.2	10.7	B4345*C5158M000
1500	64.3 × 80.7	63	95	76	17	6.1	11.4	B4345*D5158M00#
2200	64.3 × 105.7	50	75	60	21	7.5	12.8	B4345*C5228M00#
3300	64.3 × 143.2	30	45	36	26	9.4	14.3	B4345*B5338M00#
3300	76.9 × 105.7	30	45	36	26	9.4	17.7	B4345*C5338M00#
4700	76.9 × 143.2	23	35	28	32	11.7	19.6	B4345*B5478M00#
5600	76.9 × 168.7	20	30	24	36	13.2	20.0	B4345*A5568M00#
6800	76.9 × 220.7	16	24	19	43	15.7	21.0	B4345*A5688M00#
8200	76.9 × 220.7	13	20	16	51	18.5	25.6	B4345*B5828M00#
10000	91.0 × 221.0	11	17	13	57	20.7	29.9	B4345*A5109M00#

Composition of ordering code

* = Mounting style

5 = for capacitors with ring clip/clamp mounting

7 = for capacitors with threaded stud

= Design

0 = for capacitors with standard inductance

3 = for capacitors with low inductance (13 nH) -
only capacitors with diameter $d \geq 64.3 \text{ mm}$

7 = for heat sink mounting - only capacitors with
diameter $d \geq 64.3 \text{ mm}$ and without threaded
stud

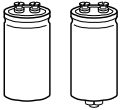

B43455, B43457

Long useful life – 85 °C

Useful life

depending on ambient temperature T_A (for natural cooling) and versus temperature of case base T_B (for base cooling) under ripple current operating conditions^{1) 2)}

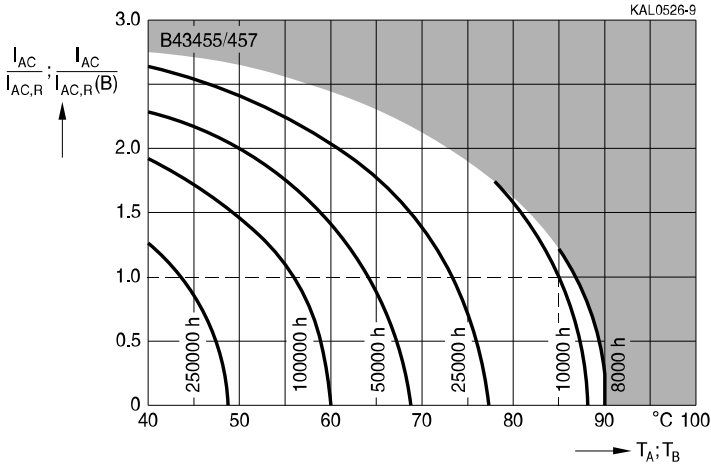

Frequency factor of permissible ripple current I_{AC} versus frequency

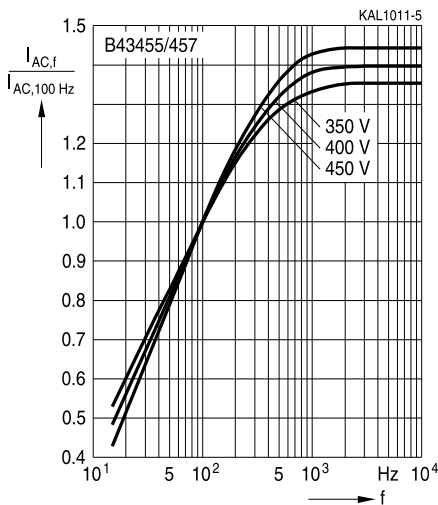

- 1) The ripple current refers to $I_{AC,R}$ for natural cooling or $I_{AC,R}(B)$ for base cooling, respectively.
- 2) Refer to chapter "General technical information, 5.3 Calculation of useful life" on how to interpret the useful life graphs.



Frequency characteristics of ESR

Typical behavior

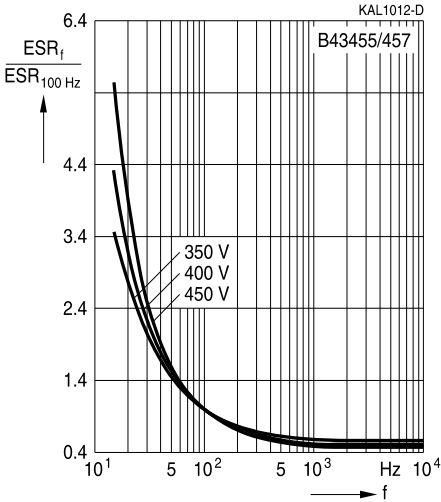

Impedance Z versus frequency f

Typical behavior at 20 °C

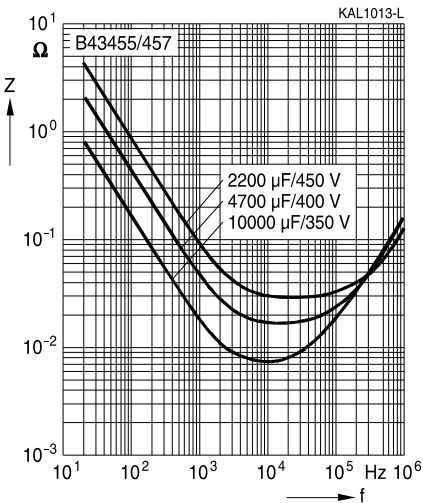

**B43455, B43457****Long useful life – 85 °C**

Cautions and warnings

Personal safety

The electrolytes used by EPCOS have not only been optimized with a view to the intended application, but also with regard to health and environmental compatibility. They do not contain any solvents that are detrimental to health, e.g. dimethyl formamide (DMF) or dimethyl acetamide (DMAC).

Furthermore, part of the high-voltage electrolytes used by EPCOS are self-extinguishing. They contain flame-retarding substances which will quickly extinguish any flame that may have been ignited.

As far as possible, EPCOS does not use any dangerous chemicals or compounds to produce operating electrolytes. However, in exceptional cases, such materials must be used in order to achieve specific physical and electrical properties because no safe substitute materials are currently known. However, the amount of dangerous materials used in our products has been limited to an absolute minimum. Nevertheless, the following rules should be observed when handling Al electrolytic capacitors:

- Any escaping electrolyte should not come into contact with eyes or skin.
- If electrolyte does come into contact with the skin, wash the affected parts immediately with running water. If the eyes are affected, rinse them for 10 minutes with plenty of water. If symptoms persist, seek medical treatment.
- Avoid breathing in electrolyte vapor or mists. Workplaces and other affected areas should be well ventilated. Clothing that has been contaminated by electrolyte must be changed and rinsed in water.

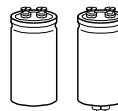

Product safety

The table below summarize the safety instructions that must be observed without fail. A detailed description can be found in the relevant sections of chapter "General technical information".

Topic	Safety information	Reference Chapter "General technical information"
Polarity	Make sure that polar capacitors are connected with the right polarity.	1 "Basic construction of aluminum electrolytic capacitors"
Reverse voltage	Voltages polarity classes should be prevented by connecting a diode.	3.1.6 "Reverse voltage"
Upper category temperature	Do not exceed the upper category temperatur.	7.2 "Maximum permissible operating temperature"
Maintenance	Make periodic inspections of the capacitors. Before the inspection, make sure that the power supply is turned off and carefully discharge the electricity of the capacitors. Do not apply any mechanical stress to the capacitor terminals.	10 "Maintenance"
Mounting position of screw terminal capacitors	Do not mount the capacitor with the terminals (safety vent) upside down.	11.1. "Mounting positions of capacitors with screw terminals"
Mounting of single-ended capacitors	The internal structure of single-ended capacitors might be damaged if excessive force is applied to the lead wires. Avoid any compressive, tensile or flexural stress. Do not move the capacitor after soldering to PC board. Do not pick up the PC board by the soldered capacitor. Do not insert the capacitor on the PC board with a hole space different to the lead space specified.	11.4 "Mounting considerations for single-ended capacitors"
Robustness of terminals	The following maximum tightening torques must not be exceeded when connecting screw terminals: M5: 2 Nm M6: 2.5 Nm	11.3 "Mounting torques"
Soldering	Do not exceed the specified time or temperature limits during soldering.	11.5 "Soldering"

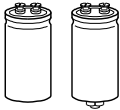

B43455, B43457

Long useful life – 85 °C

Topic	Safety information	Reference Chapter "General technical information"
Soldering, cleaning agents	Do not allow halogenated hydrocarbons to come into contact with aluminum electrolytic capacitors.	11.6 "Cleaning agents"
Passive flammability	Avoid external energy, such as fire or electricity.	8.1 "Passive flammability"
Active flammability	Avoid overload of the capacitors.	8.2 "Active flammability"
		Reference Chapter "Capacitors with screw terminals"
Breakdown strength of insulating sleeves	Do not damage the insulating sleeve, especially when ring clips are used for mounting.	"Screw terminals - accessories"

Important notes

The following applies to all products named in this publication:

1. Some parts of this publication contain **statements about the suitability of our products for certain areas of application**. These statements are based on our knowledge of typical requirements that are often placed on our products in the areas of application concerned. We nevertheless expressly point out **that such statements cannot be regarded as binding statements about the suitability of our products for a particular customer application**. As a rule, EPCOS is either unfamiliar with individual customer applications or less familiar with them than the customers themselves. For these reasons, it is always ultimately incumbent on the customer to check and decide whether an EPCOS product with the properties described in the product specification is suitable for use in a particular customer application.
2. We also point out that **in individual cases, a malfunction of passive electronic components or failure before the end of their usual service life cannot be completely ruled out in the current state of the art, even if they are operated as specified**. In customer applications requiring a very high level of operational safety and especially in customer applications in which the malfunction or failure of a passive electronic component could endanger human life or health (e.g. in accident prevention or life-saving systems), it must therefore be ensured by means of suitable design of the customer application or other action taken by the customer (e.g. installation of protective circuitry or redundancy) that no injury or damage is sustained by third parties in the event of malfunction or failure of a passive electronic component.
3. **The warnings, cautions and product-specific notes must be observed.**
4. In order to satisfy certain technical requirements, **some of the products described in this publication may contain substances subject to restrictions in certain jurisdictions (e.g. because they are classed as hazardous)**. Useful information on this will be found in our Material Data Sheets on the Internet (www.epcos.com/material). Should you have any more detailed questions, please contact our sales offices.
5. We constantly strive to improve our products. Consequently, **the products described in this publication may change from time to time**. The same is true of the corresponding product specifications. Please check therefore to what extent product descriptions and specifications contained in this publication are still applicable before or when you place an order. We also **reserve the right to discontinue production and delivery of products**. Consequently, we cannot guarantee that all products named in this publication will always be available. The aforementioned does not apply in the case of individual agreements deviating from the foregoing for customer-specific products.
6. Unless otherwise agreed in individual contracts, **all orders are subject to the current version of the “General Terms of Delivery for Products and Services in the Electrical Industry” published by the German Electrical and Electronics Industry Association (ZVEI)**.
7. The trade names EPCOS, BAOKE, Alu-X, CeraDiode, CSSP, MiniBlue, MKK, MLSC, MotorCap, PCC, PhaseCap, PhaseMod, SIFERRIT, SIFI, SIKOREL, SilverCap, SIMDAD, SIMID, SineFormer, SIOV, SIP5D, SIP5K, ThermoFuse, WindCap are **trademarks registered or pending** in Europe and in other countries. Further information will be found on the Internet at www.epcos.com/trademarks.