

# BAS19LT1, BAS20LT1, BAS21LT1, BAS21DW5T1

Preferred Devices

## High Voltage Switching Diode

Device Marking:

- BAS19LT1 = JP
- BAS20LT1 = JR
- BAS21LT1 = JS
- BAS21DW5T1 = JS

### Features

- Pb-Free Package is Available

### MAXIMUM RATINGS

Rating	Symbol	Value	Unit
Continuous Reverse Voltage	$V_R$	120 200 250	Vdc
Repetitive Peak Reverse Voltage	$V_{RRM}$	120 200 250	Vdc
Continuous Forward Current	$I_F$	200	mAdc
Peak Forward Surge Current	$I_{FM(surge)}$	625	mAdc
Maximum Junction Temperature	$T_{Jmax}$	150	°C
Power Dissipation (Note 4)	$P_D$	385	mW

1. Mounted on FR-5 Board = 1.0 x 0.75 x 0.062 in.

Maximum ratings are those values beyond which device damage can occur. Maximum ratings applied to the device are individual stress limit values (not normal operating conditions) and are not valid simultaneously. If these limits are exceeded, device functional operation is not implied, damage may occur and reliability may be affected.



ON Semiconductor®

<http://onsemi.com>

## HIGH VOLTAGE SWITCHING DIODE

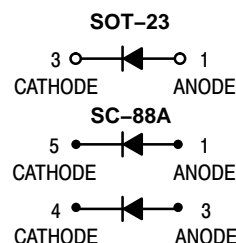

### MARKING DIAGRAMS

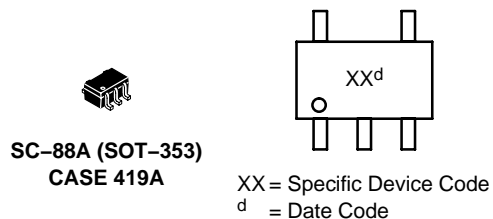
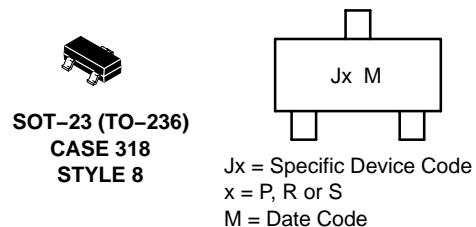

### ORDERING INFORMATION

Device	Package	Shipping†
BAS19LT1	SOT-23	3000 / Tape & Reel
BAS19LT3	SOT-23	10000 / Tape & Reel
BAS20LT1	SOT-23	3000 / Tape & Reel
BAS21LT1	SOT-23	3000 / Tape & Reel
BAS21LT1G	SOT-23 (Pb-Free)	3000 / Tape & Reel
BAS21LT3	SOT-23	10000 / Tape & Reel
BAS21DW5T1	SC-88A	3000 / Tape & Reel

†For information on tape and reel specifications, including part orientation and tape sizes, please refer to our Tape and Reel Packaging Specifications Brochure, BRD8011/D.

Preferred devices are recommended choices for future use and best overall value.

# BAS19LT1, BAS20LT1, BAS21LT1, BAS21DW5T1

## THERMAL CHARACTERISTICS (SOT-23)

Characteristic	Symbol	Max	Unit
Total Device Dissipation FR-5 Board (Note 2) $T_A = 25^\circ\text{C}$ Derate above $25^\circ\text{C}$	$P_D$	225	mW
		1.8	mW/ $^\circ\text{C}$
Thermal Resistance Junction-to-Ambient (SOT-23)	$R_{\theta JA}$	556	$^\circ\text{C}/\text{W}$
Total Device Dissipation Alumina Substrate (Note 3) $T_A = 25^\circ\text{C}$ Derate above $25^\circ\text{C}$	$P_D$	300	mW
		2.4	mW/ $^\circ\text{C}$
Thermal Resistance Junction-to-Ambient	$R_{\theta JA}$	417	$^\circ\text{C}/\text{W}$
Junction and Storage Temperature Range	$T_J, T_{stg}$	-55 to +150	$^\circ\text{C}$

## THERMAL CHARACTERISTICS (SC-88A)

Characteristic	Symbol	Max	Unit
Power Dissipation (Note 4)	$P_D$	385	mW
Thermal Resistance – Junction-to-Ambient Derate Above $25^\circ\text{C}$	$R_{\theta JA}$	328 3.0	$^\circ\text{C}/\text{W}$ mW/ $^\circ\text{C}$
Maximum Junction Temperature	$T_{Jmax}$	150	$^\circ\text{C}$
Operating Junction and Storage Temperature Range	$T_J, T_{stg}$	-55 to +150	$^\circ\text{C}$

2. FR-5 =  $1.0 \times 0.75 \times 0.062$  in.

3. Alumina =  $0.4 \times 0.3 \times 0.024$  in. 99.5% alumina.

4. Mounted on FR-5 Board =  $1.0 \times 0.75 \times 0.062$  in.

## ELECTRICAL CHARACTERISTICS ( $T_A = 25^\circ\text{C}$ unless otherwise noted)

Characteristic	Symbol	Min	Max	Unit
Reverse Voltage Leakage Current ( $V_R = 100$ Vdc)      BAS19 ( $V_R = 150$ Vdc)      BAS20 ( $V_R = 200$ Vdc)      BAS21 ( $V_R = 100$ Vdc, $T_J = 150^\circ\text{C}$ )      BAS19 ( $V_R = 150$ Vdc, $T_J = 150^\circ\text{C}$ )      BAS20 ( $V_R = 200$ Vdc, $T_J = 150^\circ\text{C}$ )      BAS21	$I_R$	–	0.1 0.1 0.1 100 100 100	$\mu\text{A}dc$
Reverse Breakdown Voltage ( $I_{BR} = 100$ $\mu\text{A}dc$ )      BAS19 ( $I_{BR} = 100$ $\mu\text{A}dc$ )      BAS20 ( $I_{BR} = 100$ $\mu\text{A}dc$ )      BAS21	$V_{(BR)}$	120 200 250	– – –	Vdc
Forward Voltage ( $I_F = 100$ mA)dc      BAS19 ( $I_F = 200$ mA)dc      BAS20 ( $I_F = 200$ mA)dc      BAS21	$V_F$	– –	1.0 1.25	Vdc
Diode Capacitance ( $V_R = 0$ , $f = 1.0$ MHz)	$C_D$	–	5.0	pF
Reverse Recovery Time ( $I_F = I_R = 30$ mA)dc, $I_{R(REC)} = 3.0$ mA)dc, $R_L = 100$ )	$t_{rr}$	–	50	ns

# BAS19LT1, BAS20LT1, BAS21LT1, BAS21DW5T1

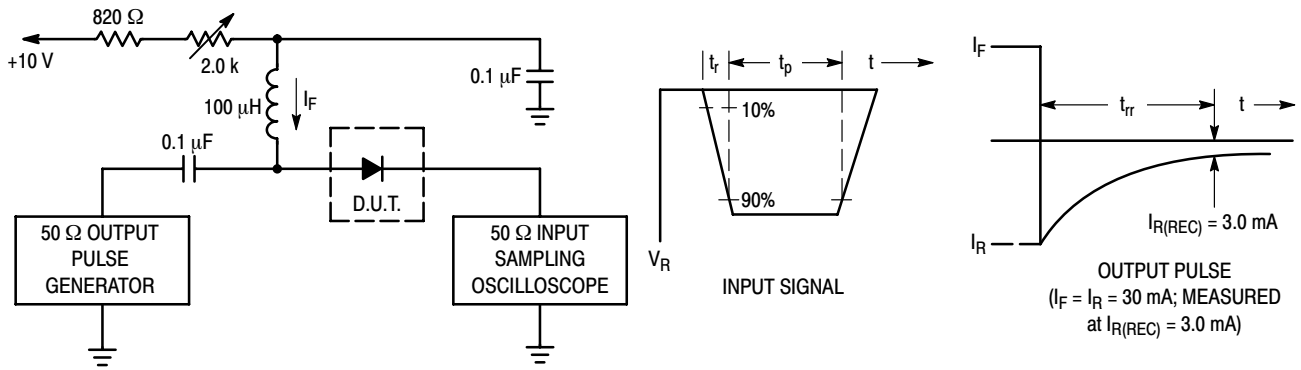

- Notes: 1. A 2.0 kΩ variable resistor adjusted for a Forward Current ( $I_F$ ) of 30 mA.  
 2. Input pulse is adjusted so  $I_{R(\text{peak})}$  is equal to 30 mA.  
 3.  $t_p \gg t_{rr}$

**Figure 1. Recovery Time Equivalent Test Circuit**

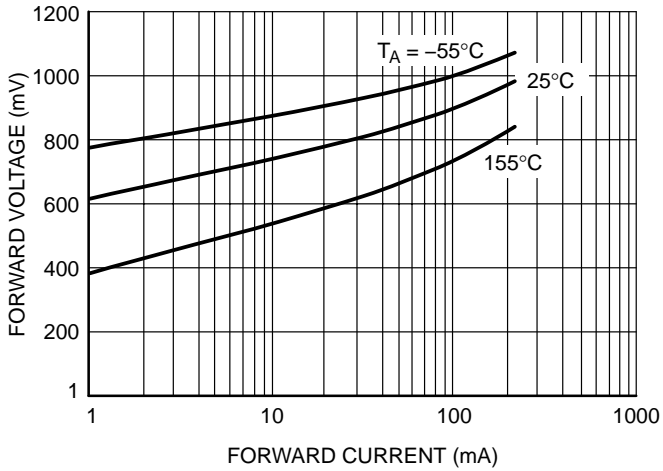

**Figure 2. Forward Voltage**

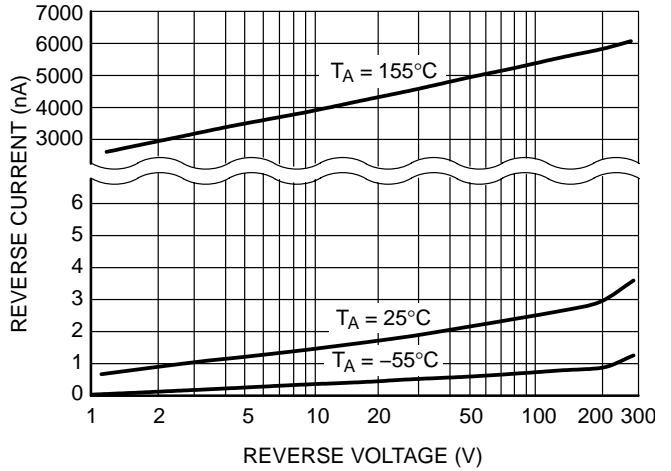
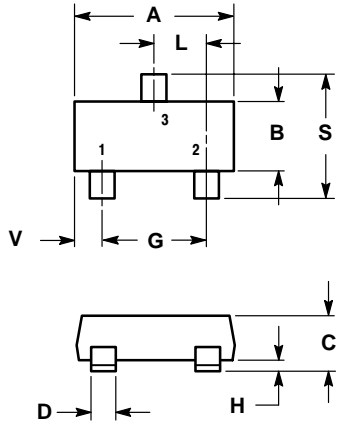

**Figure 3. Reverse Leakage**

# BAS19LT1, BAS20LT1, BAS21LT1, BAS21DW5T1

## PACKAGE DIMENSIONS

SOT-23 (TO-236)  
CASE 318-09  
ISSUE AH



NOTES:

1. DIMENSIONING AND TOLERANCING PER ANSI Y14.5M, 1982.
2. CONTROLLING DIMENSION: INCH.
3. MAXIMUM LEAD THICKNESS INCLUDES LEAD FINISH THICKNESS. MINIMUM LEAD THICKNESS IS THE MINIMUM THICKNESS OF BASE MATERIAL.
4. 318-01, -02, AND -06 OBSOLETE, NEW STANDARD 318-09.

DIM	INCHES		MILLIMETERS	
	MIN	MAX	MIN	MAX
A	0.1102	0.1197	2.80	3.04
B	0.0472	0.0551	1.20	1.40
C	0.0385	0.0498	0.99	1.26
D	0.0140	0.0200	0.36	0.50
G	0.0670	0.0826	1.70	2.10
H	0.0040	0.0098	0.10	0.25
J	0.0034	0.0070	0.085	0.177
K	0.0180	0.0236	0.45	0.60
L	0.0350	0.0401	0.89	1.02
S	0.0830	0.0984	2.10	2.50
V	0.0177	0.0236	0.45	0.60

STYLE 8:

- PIN 1. ANODE
- NO CONNECTION
- CATHODE

### SOLDERING FOOTPRINT\*

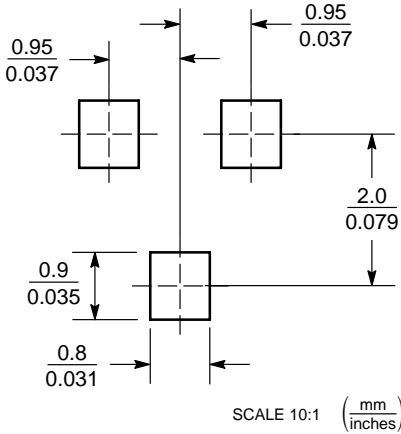

\*For additional information on our Pb-Free strategy and soldering details, please download the ON Semiconductor Soldering and Mounting Techniques Reference Manual, SOLDERRM/D.

# BAS19LT1, BAS20LT1, BAS21LT1, BAS21DW5T1

## PACKAGE DIMENSIONS

SC-88A (SOT-353)  
CASE 419A-02  
ISSUE G

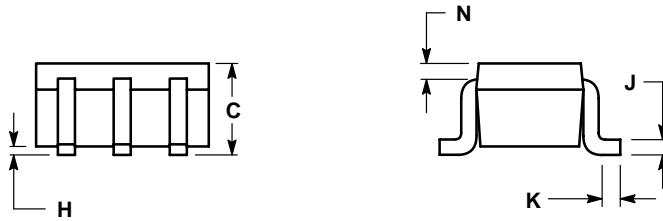
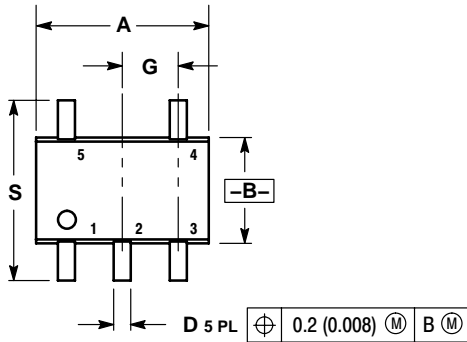

NOTES:

1. DIMENSIONING AND TOLERANCING PER ANSI Y14.5M, 1982.
2. CONTROLLING DIMENSION: INCH.
3. 419A-01 OBSOLETE. NEW STANDARD 419A-02.
4. DIMENSIONS A AND B DO NOT INCLUDE MOLD FLASH, PROTRUSIONS, OR GATE BURRS.

DIM	INCHES		MILLIMETERS	
	MIN	MAX	MIN	MAX
A	0.071	0.087	1.80	2.20
B	0.045	0.053	1.15	1.35
C	0.031	0.043	0.80	1.10
D	0.004	0.012	0.10	0.30
G	0.026 BSC		0.65 BSC	
H	---	0.004	---	0.10
J	0.004	0.010	0.10	0.25
K	0.004	0.012	0.10	0.30
N	0.008 REF		0.20 REF	
S	0.079	0.087	2.00	2.20

### SOLDERING FOOTPRINT\*

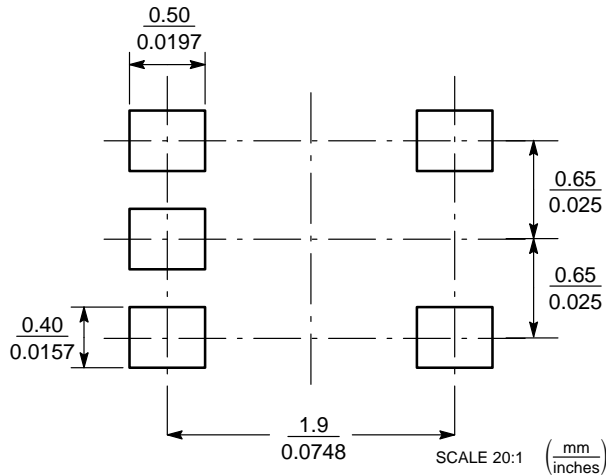

\*For additional information on our Pb-Free strategy and soldering details, please download the ON Semiconductor Soldering and Mounting Techniques Reference Manual, SOLDERRM/D.

# BAS19LT1, BAS20LT1, BAS21LT1, BAS21DW5T1

**ON Semiconductor** and  are registered trademarks of Semiconductor Components Industries, LLC (SCILLC). SCILLC reserves the right to make changes without further notice to any products herein. SCILLC makes no warranty, representation or guarantee regarding the suitability of its products for any particular purpose, nor does SCILLC assume any liability arising out of the application or use of any product or circuit, and specifically disclaims any and all liability, including without limitation special, consequential or incidental damages. "Typical" parameters which may be provided in SCILLC data sheets and/or specifications can and do vary in different applications and actual performance may vary over time. All operating parameters, including "Typicals" must be validated for each customer application by customer's technical experts. SCILLC does not convey any license under its patent rights nor the rights of others. SCILLC products are not designed, intended, or authorized for use as components in systems intended for surgical implant into the body, or other applications intended to support or sustain life, or for any other application in which the failure of the SCILLC product could create a situation where personal injury or death may occur. Should Buyer purchase or use SCILLC products for any such unintended or unauthorized application, Buyer shall indemnify and hold SCILLC and its officers, employees, subsidiaries, affiliates, and distributors harmless against all claims, costs, damages, and expenses, and reasonable attorney fees arising out of, directly or indirectly, any claim of personal injury or death associated with such unintended or unauthorized use, even if such claim alleges that SCILLC was negligent regarding the design or manufacture of the part. SCILLC is an Equal Opportunity/Affirmative Action Employer. This literature is subject to all applicable copyright laws and is not for resale in any manner.

## PUBLICATION ORDERING INFORMATION

### LITERATURE FULFILLMENT:

Literature Distribution Center for ON Semiconductor  
P.O. Box 5163, Denver, Colorado 80217 USA

**Phone:** 303-675-2175 or 800-344-3860 Toll Free USA/Canada

**Fax:** 303-675-2176 or 800-344-3867 Toll Free USA/Canada

**Email:** [orderlit@onsemi.com](mailto:orderlit@onsemi.com)

**N. American Technical Support:** 800-282-9855 Toll Free  
USA/Canada

**Japan:** ON Semiconductor, Japan Customer Focus Center  
2-9-1 Kamimeguro, Meguro-ku, Tokyo, Japan 153-0051  
**Phone:** 81-3-5773-3850

**ON Semiconductor Website:** <http://onsemi.com>

**Order Literature:** <http://www.onsemi.com/litorder>

For additional information, please contact your  
local Sales Representative.