

Optocoupler, Phototriac Output, Zero Crossing

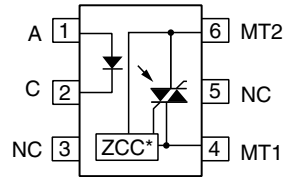

*Zero crossing circuit

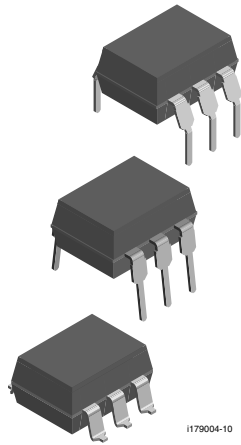

I179030_3

FEATURES

- High input sensitivity $I_{FT} = 1 \text{ mA}$
- $I_{TRMS} = 300 \text{ mA}$
- High static dV/dt $10\,000 \text{ V}/\mu\text{s}$
- Electrically insulated between input and output circuit
- Microcomputer compatible
- Trigger current
 - ($I_{FT} < 1.2 \text{ mA}$) BRT22F, BRT23F,
 - ($I_{FT} < 2 \text{ mA}$) BRT21H, BRT22H, BRT23H
 - ($I_{FT} < 3 \text{ mA}$) BRT21M, BRT22M, BRT23M
- Available surface mount and on on tape and reel
- Zero voltage crossing detector
- Compliant to RoHS Directive 2002/95/EC and in accordance to WEEE 2002/96/EC



RoHS
COMPLIANT

DESCRIPTION

The BRT21, BRT22, BRT23 product family consists of AC switch optocouplers with zero voltage detectors with two electrically insulated lateral power ICs which integrate a thyristor system, a photo detector and noise suppression at the output and an IR GaAs diode input.

High input sensitivity is achieved by using an emitter follower phototransistor and a SCR predriver resulting in an LED trigger current of less than 2 mA or 3 mA (DC). Inverse parallel SCRs provide commutating dV/dt greater than $10 \text{ kV}/\mu\text{s}$.

The zero cross line voltage detection circuit consists of two MOSFETS and a photodiode.

The BRT21, BRT22, BRT23 product family isolates low-voltage logic from 120, 230, and 380 VAC lines to control resistive, inductive or capacitive loads including motors, solenoids, high current thyristors or TRIAC and relays.

APPLICATIONS

- Industrial controls
- Office equipment
- Consumer appliances

AGENCY APPROVALS

- UL file no. E52744 system code H
- DIN EN 60747-5-2 (VDE 0844)/DIN EN 60747-5-5 (pending) available with option 1
- CQC

ORDERING INFORMATION

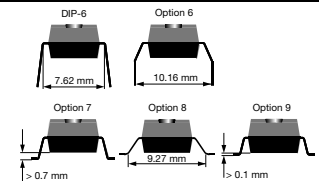
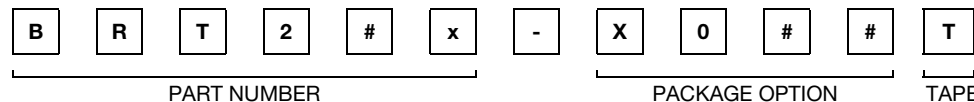

AGENCY CERTIFIED/PACKAGE	$V_{DRM} \text{ (V)}$								
	≤ 400		≤ 600			≤ 800			
UL	$I_{FT} = 2 \text{ mA}$	$I_{FT} = 3 \text{ mA}$	$I_{FT} = 1.2 \text{ mA}$	$I_{FT} = 2 \text{ mA}$	$I_{FT} = 3 \text{ mA}$	$I_{FT} = 1.2 \text{ mA}$	$I_{FT} = 2 \text{ mA}$	$I_{FT} = 3 \text{ mA}$	
DIP-6	BRT21H	BRT21M	BRT22F	BRT22H	BRT22M	BRT23F	BRT23H	BRT23M	
DIP-6, 400 mil, option 6	-	-	BRT22F-X006	-	-	BRT23F-X006	BRT23H-X006	-	
SMD-6, option 7	BRT21H-X007	-	BRT22F-X007T ⁽¹⁾	BRT22H-X007T ⁽¹⁾	-	BRT23F-X007T ⁽¹⁾	BRT23H-X007T ⁽¹⁾	BRT23M-X007T	
SMD-6, option 9	-	-	BRT22F-X009T ⁽¹⁾	-	-	BRT23F-X009T	-	-	



AGENCY CERTIFIED/PACKAGE	V _{DRM} (V)							
	≤ 400		≤ 600			≤ 800		
UL, VDE	I _{FT} = 2 mA	I _{FT} = 3 mA	I _{FT} = 1.2 mA	I _{FT} = 2 mA	I _{FT} = 3 mA	I _{FT} = 1.2 mA	I _{FT} = 2 mA	I _{FT} = 3 mA
DIP-6	-	-	BRT22F-X001	BRT22H-X001	-	-	BRT23H-X001	-
DIP-6, option 6	BRT21H-X016	BRT21M-X016	BRT22F-X016	BRT22H-X016	BRT22M-X016	-	BRT22H-X016	BRT23M-X016
SMD-6, option 7	-	-	BRT22F-X017T	BRT22H-X017	-	-	-	-
SMD-6, option 8	-	-	-	-	-	-	BRT23H-X018T	-

Note

(1) Also available in tube, do not put T on the end.

ABSOLUTE MAXIMUM RATINGS (T _{amb} = 25 °C, unless otherwise specified)						
PARAMETER	TEST CONDITION	PART	SYMBOL	VALUE	UNIT	
INPUT						
Reverse voltage	I _R = 10 μA		V _R	6	V	
Forward current			I _F	60	mA	
Surge current			I _{FSM}	2.5	A	
Power dissipation			P _{diss}	100	mW	
Derate from 25 °C				1.33	mW/°C	
OUTPUT						
Peak off-state voltage		BRT21	V _{DRM}	400	V	
		BRT22	V _{DRM}	600	V	
		BRT23	V _{DRM}	800	V	
On state RMS current			I _{TRM}	300	mA	
Single cycle surge current				3	A	
Power dissipation			P _{diss}	600	mW	
Derate from 25 °C				6.6	mW/°C	
COUPLER						
Isolation test voltage (between emitter and detector, climate per DIN 500414, part 2, Nov. 74)	t = 1 s		V _{ISO}	5300	V _{RMS}	
Pollution degree (DIN VDE 0109)				2		
Creepage distance				≥ 7	mm	
Clearance distance				≥ 7	mm	
Comparative tracking index per DIN IEC 112/VDE 0303 part 1, group IIIa per DIN VDE 6110			CTI	≥ 175		
Isolation resistance	V _{IO} = 500 V, T _{amb} = 25 °C		R _{IO}	≥ 10 ¹²	Ω	
	V _{IO} = 500 V, T _{amb} = 100 °C		R _{IO}	≥ 10 ¹¹	Ω	
Storage temperature range			T _{stg}	- 40 to + 150	°C	
Ambient temperature range			T _{amb}	- 40 to + 100	°C	
Soldering temperature (1)	max. ≤ 10 s dip soldering ≥ 0.5 mm from case bottom		T _{slid}	260	°C	

Notes

- Stresses in excess of the absolute maximum ratings can cause permanent damage to the device. Functional operation of the device is not implied at these or any other conditions in excess of those given in the operational sections of this document. Exposure to absolute maximum ratings for extended periods of the time can adversely affect reliability.

(1) Refer to reflow profile for soldering conditions for surface mounted devices (SMD). Refer to wave profile for soldering conditions for through hole devices (DIP).



ELECTRICAL CHARACTERISTICS ($T_{amb} = 25\text{ }^{\circ}\text{C}$, unless otherwise specified)							
PARAMETER	TEST CONDITION	PART	SYMBOL	MIN.	TYP.	MAX.	UNIT
INPUT							
Forward voltage	$I_F = 10\text{ mA}$		V_F		1.16	1.35	V
Reverse current	$V_R = 6\text{ V}$		I_R		0.1	10	μA
Capacitance	$f = 1\text{ MHz}, V_F = 0\text{ V}$		C_O		25		pF
Thermal resistance, junction to ambient			R_{thJA}		750		K/W
OUTPUT							
Peak off-state voltage	$I_{D(RMS)} = 100\text{ }\mu\text{A}$	BRT21	V_{DM}		400		V
		BRT22			600		
		BRT23			800		
Off-state current	$V_D = V_{DRM}, T_{amb} = 100\text{ }^{\circ}\text{C}, I_F = 0\text{ mA}$		$I_{D(RMS)}$		10	100	μA
On-state voltage	$I_T = 300\text{ mA}$		V_{TM}		1.7	3	V
On-state current	$PF = 1, V_{T(RMS)} = 1.7\text{ V}$		I_{TM}			300	mA
Surge (non-repetitive), on-state current	$f = 50\text{ Hz}$		I_{TSM}			3	A
Trigger current temp. gradient			$\Delta I_{FT1}/\Delta T_j$		7	14	$\mu\text{A/K}$
				$\Delta I_{FT2}/\Delta T_j$		7	14
Inhibit voltage temp. gradient			$\Delta V_{DINH}/\Delta T_j$		-20		mV/K
Off-state current in inhibit state	$I_F = I_{FT1}, V_{DRM}$		I_{DINH}		50	200	μA
Holding current			I_H		65	500	μA
Latching current	$V_T = 2.2\text{ V}$		I_L		5		mA
Zero cross inhibit voltage	$I_F = \text{rated } I_{FT}$		V_{IH}		15	25	V
Turn-on time	$V_{RM} = V_{DM} = V_{D(RMS)}$		t_{on}		35		μs
Turn-off time	$PF = 1, I_T = 300\text{ mA}$		t_{off}		50		μs
Critical rate of rise of off-state voltage	$V_D = 0.67 V_{DRM}, T_j = 25\text{ }^{\circ}\text{C}$		dV/dt_{cr}	10 000			V/ μs
				5000			V/ μs
Critical rate of rise of voltage at current commutation	$V_D = 230 V_{RMS}, I_D = 300\text{ mA}_{RMS}, T_j = 25\text{ }^{\circ}\text{C}$		dV/dt_{crq}		8		V/ μs
					7		V/ μs
Critical rate of rise of on-state at current commutation	$V_D = 230 V_{RMS}, I_D = 300\text{ mA}_{RMS}, T_j = 25\text{ }^{\circ}\text{C}$		dl/dt_{crq}		12		A/ms
Thermal resistance, junction to ambient			R_{thJA}		125		K/W
COUPLER							
Critical rate of rise of coupled input/output voltage	$I_T = 0\text{ A}, V_{RM} = V_{DM} = V_{D(RMS)}$		dV_{IO}/dt		10 000		V/ μs
Common mode coupling capacitance			C_{CM}		0.01		pF
Capacitance (input to output)	$f = 1\text{ MHz}, V_{IO} = 0\text{ V}$		C_{IO}		0.8		pF
Isolation resistance	$V_{IO} = 500\text{ V}, T_{amb} = 25\text{ }^{\circ}\text{C}$		R_{is}		$\geq 10^{12}$		Ω
	$V_{IO} = 500\text{ V}, T_{amb} = 100\text{ }^{\circ}\text{C}$		R_{is}		$\geq 10^{11}$		Ω
Trigger current	$V_D = 5\text{ V}, F$ - versions		I_{FT}			1.2	mA
	$V_D = 5\text{ V}, H$ - versions		I_{FT}			2	mA
	$V_D = 5\text{ V}, M$ - versions		I_{FT}			3	mA

Note

- Minimum and maximum values are testing requirements. Typical values are characteristics of the device and are the result of engineering evaluation. Typical values are for information only and are not part of the testing requirements.



SAFETY AND INSULATION RATINGS						
PARAMETER	TEST CONDITION	SYMBOL	MIN.	TYP.	MAX.	UNIT
Climatic classification (according to IEC 68 part 1)				40/100/21		
Comparative tracking index		CTI	175		399	
V _{IOTM}			6000			V
V _{IORM}			630			V
P _{SO}					200	mW
I _{SI}					400	mA
T _{SI}					175	°C
Creepage distance	standard DIP-6		7			mm
Clearance distance	standard DIP-6		7			mm
Creepage distance	400 mil DIP-6		8			mm
Clearance distance	400 mil DIP-6		8			mm

Note

- As per IEC 60747-5-2, § 7.4.3.8.1, this optocoupler is suitable for “safe electrical insulation” only within the safety ratings. Compliance with the safety ratings shall be ensured by means of protective circuits.

POWER FACTOR CONSIDERATIONS

A snubber is not needed to eliminate false operation of the TRIAC driver because of the high static and commutating dV/dt with loads between 1.0 and 0.8 power factors. When inductive loads with power factors less than 0.8 are being driven, include a RC snubber or a single capacitor directly across the device to damp the peak commutating dV/dt spike. Normally a commutating dV/dt causes a turning-off device to stay on due to the stored energy remaining in the turning-off device.

But in the case of a zero voltage crossing optotriac, the commutating dV/dt spikes can inhibit one half of the TRIAC from turning on. If the spike potential exceeds the inhibit voltage of the zero cross detection circuit, half of the TRIAC will be held off and not turn-on. This hold-off condition can be eliminated by using a snubber or capacitor placed directly across the optotriac as shown in figure 1. Note that the value of the capacitor increases as a function of the load current.

The hold-off condition also can be eliminated by providing a higher level of LED drive current. The higher LED drive provides a larger photocurrent which causes the phototransistor to turn-on before the commutating spike has activated the zero cross network. Figure 2 shows the relationship of the LED drive for power factors of less than 1.0. The curve shows that if a device requires 1.5 mA for a resistive load, then 1.8 times 2.7 mA that amount would be required to control an inductive load whose power factor is less than 0.3.

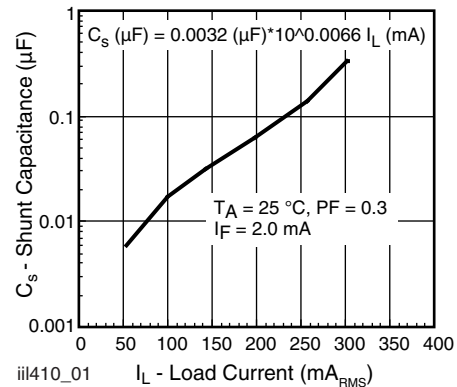
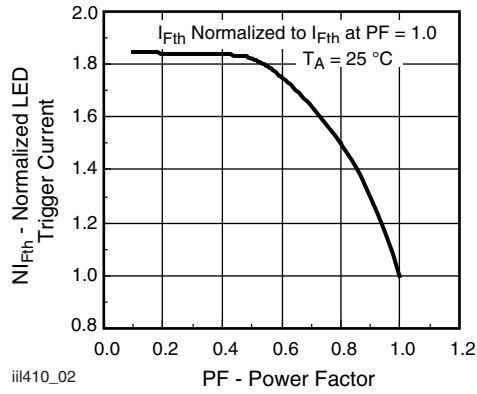

Fig. 1 - Shunt Capacitance vs. Load Current

TYPICAL CHARACTERISTICS ($T_{amb} = 25\text{ }^{\circ}\text{C}$, unless otherwise specified)



iii410_02

Fig. 2 - Normalized LED Trigger Current vs. Power Factor

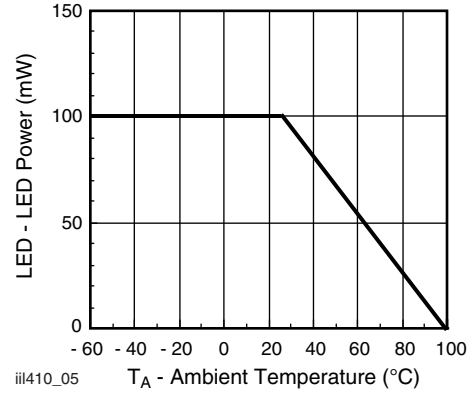

iii410_05

Fig. 5 - Maximum LED Power Dissipation

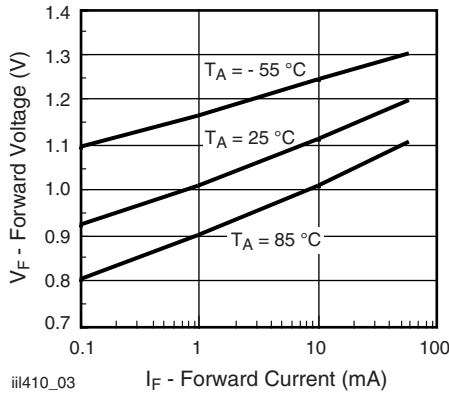

iii410_03

Fig. 3 - Forward Voltage vs. Forward Current

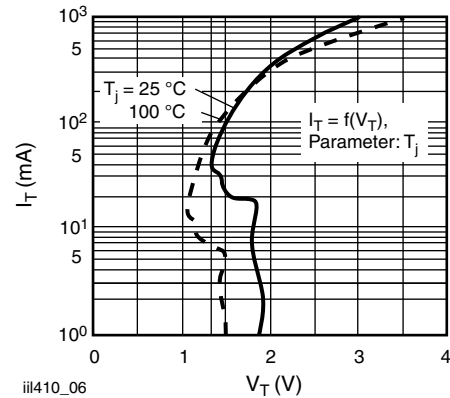

iii410_06

Fig. 6 - Typical Output Characteristics

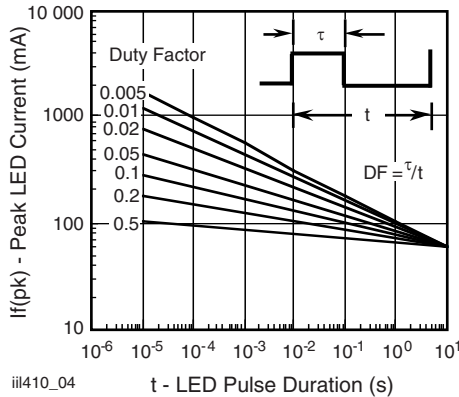

iii410_04

Fig. 4 - Peak LED Current vs. Duty Factor, τ

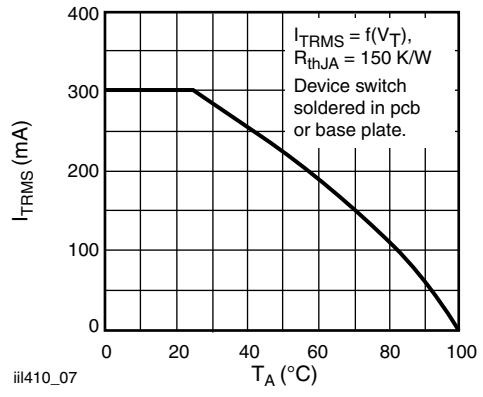

iii410_07

Fig. 7 - Current Reduction

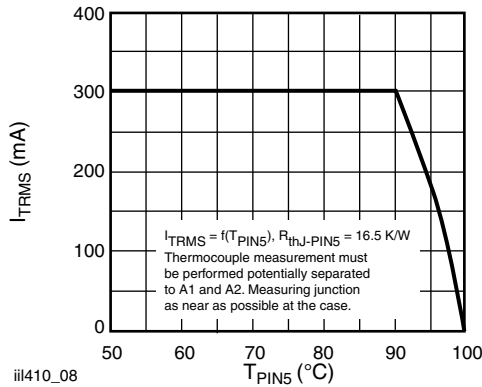

Fig. 8 - Current Reduction

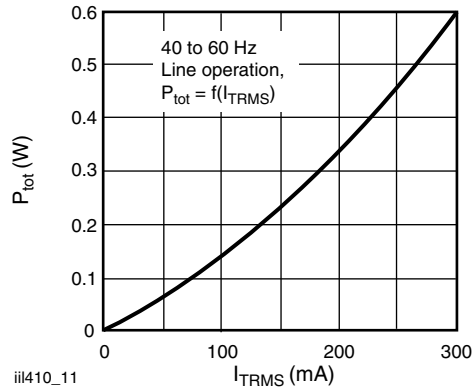

Fig. 11 - Power Dissipation 40 Hz to 60 Hz Line Operation

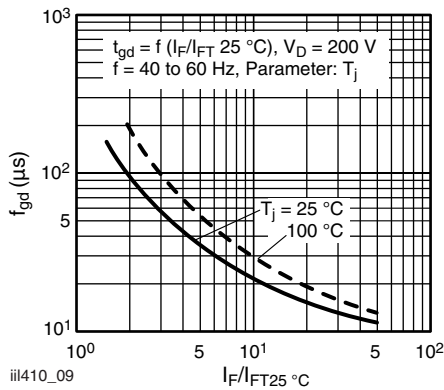

Fig. 9 - Typical Trigger Delay Time

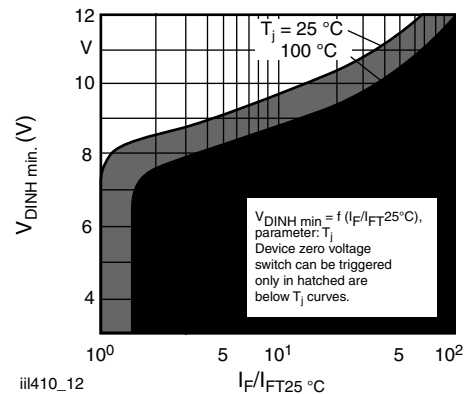

Fig. 12 - Typical Static Inhibit Voltage Limit

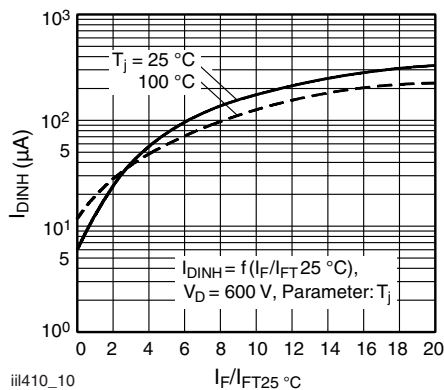

Fig. 10 - Typical Inhibit Current

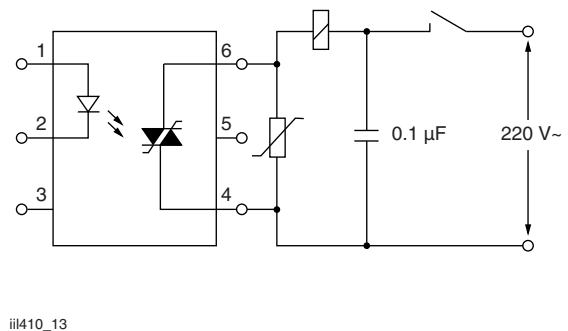
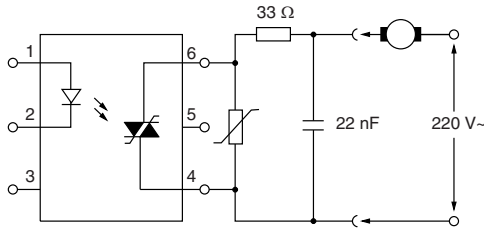
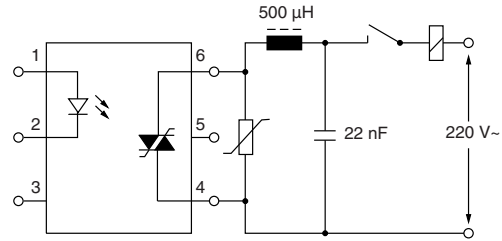

Fig. 13 - Apply a Capacitor to the Supply Pins at the Load-Side



iii410_14

Fig. 14 - Connect a Series Resistor to the Output and Bridge Both by a Capacitor



iii410_15

Fig. 15 - Connect a Choke of Low Winding Cap. in Series, e.g., a Ringcore Choke, with Higher Load Currents

TECHNICAL INFORMATION

See Application Note for additional information.

PACKAGE DIMENSIONS in millimeters

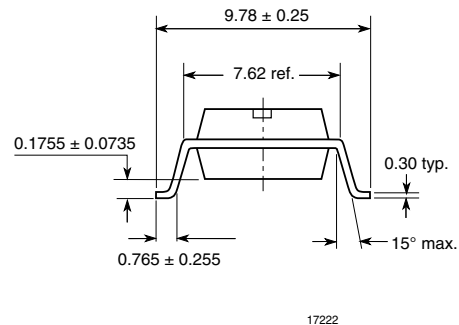
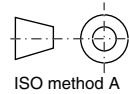
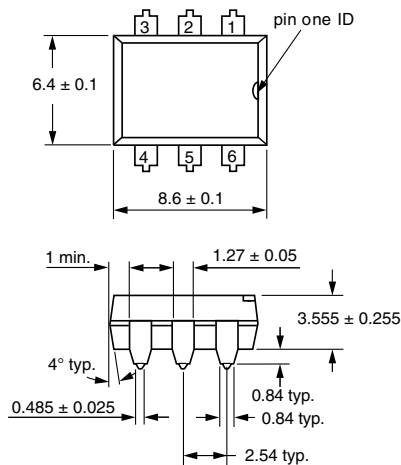

17222

Option 6

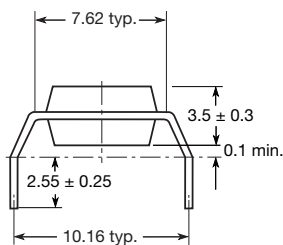

Option 7

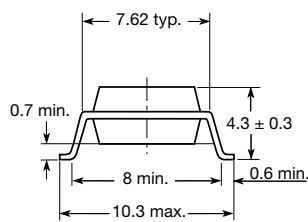

Option 8

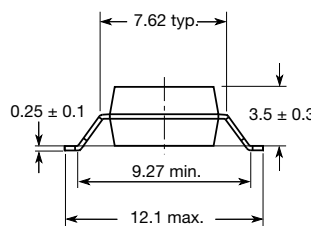

Option 9

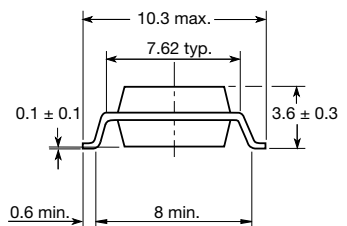

20802-40

PACKAGE MARKING (example)

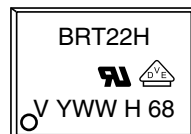

Note

- Basic product marking only, refer to option information document number 83713 for option marking



Disclaimer

ALL PRODUCT, PRODUCT SPECIFICATIONS AND DATA ARE SUBJECT TO CHANGE WITHOUT NOTICE TO IMPROVE RELIABILITY, FUNCTION OR DESIGN OR OTHERWISE.

Vishay Intertechnology, Inc., its affiliates, agents, and employees, and all persons acting on its or their behalf (collectively, "Vishay"), disclaim any and all liability for any errors, inaccuracies or incompleteness contained in any datasheet or in any other disclosure relating to any product.

Vishay makes no warranty, representation or guarantee regarding the suitability of the products for any particular purpose or the continuing production of any product. To the maximum extent permitted by applicable law, Vishay disclaims (i) any and all liability arising out of the application or use of any product, (ii) any and all liability, including without limitation special, consequential or incidental damages, and (iii) any and all implied warranties, including warranties of fitness for particular purpose, non-infringement and merchantability.

Statements regarding the suitability of products for certain types of applications are based on Vishay's knowledge of typical requirements that are often placed on Vishay products in generic applications. Such statements are not binding statements about the suitability of products for a particular application. It is the customer's responsibility to validate that a particular product with the properties described in the product specification is suitable for use in a particular application. Parameters provided in datasheets and/or specifications may vary in different applications and performance may vary over time. All operating parameters, including typical parameters, must be validated for each customer application by the customer's technical experts. Product specifications do not expand or otherwise modify Vishay's terms and conditions of purchase, including but not limited to the warranty expressed therein.

Except as expressly indicated in writing, Vishay products are not designed for use in medical, life-saving, or life-sustaining applications or for any other application in which the failure of the Vishay product could result in personal injury or death. Customers using or selling Vishay products not expressly indicated for use in such applications do so at their own risk. Please contact authorized Vishay personnel to obtain written terms and conditions regarding products designed for such applications.

No license, express or implied, by estoppel or otherwise, to any intellectual property rights is granted by this document or by any conduct of Vishay. Product names and markings noted herein may be trademarks of their respective owners.

Material Category Policy

Vishay Intertechnology, Inc. hereby certifies that all its products that are identified as RoHS-Compliant fulfill the definitions and restrictions defined under Directive 2011/65/EU of The European Parliament and of the Council of June 8, 2011 on the restriction of the use of certain hazardous substances in electrical and electronic equipment (EEE) - recast, unless otherwise specified as non-compliant.

Please note that some Vishay documentation may still make reference to RoHS Directive 2002/95/EC. We confirm that all the products identified as being compliant to Directive 2002/95/EC conform to Directive 2011/65/EU.

Vishay Intertechnology, Inc. hereby certifies that all its products that are identified as Halogen-Free follow Halogen-Free requirements as per JEDEC JS709A standards. Please note that some Vishay documentation may still make reference to the IEC 61249-2-21 definition. We confirm that all the products identified as being compliant to IEC 61249-2-21 conform to JEDEC JS709A standards.