

Circular Connectors C 16-3 Female cable connector size 1; straight, No. of contacts 17 + PE, 100 V, 6 A

Part No. C016 10E017 002 1



Series Circular Connectors C 16-3

View represents all available contact positions.

Subseries Circular Connector C 16-3

COMMON CHARACTERISTICS		
No. of contacts		17 + PE
Version		size 1; straight
Cable diameter		10-12
ELECTRICAL CHARACTERISTICS		
Rated voltage	DIN EN 60664-1 / IEC 60664-1	100V
Rated voltage	UL 1977	250V
Rated impulse voltage	DIN EN 60664-1 / IEC 60664-1	3000V
Rated current at 40°C		6 A
Installation category	DIN EN 60664-1 / IEC 60664-1	III
Insulation group	DIN EN 60664-1 / IEC 60664-1	II
Insulation resistance	DIN EN 60512-2, Test 3a / IEC 60512-2, Test 3a	≥ 10 ⁸
Contact resistance	DIN EN 60512-2, Test 2a / IEC 60512-2 Test 2a	≤ 5 m
Current carrying capacity	DIN EN 60512-3, Test 5b / IEC 60512-2 Test 5b	6 A
Pollution degree	DIN EN 60664-1 / IEC 60664-1	3
CLIMATICAL CHARACTERISTICS		
Climatic category	DIN EN 60068-1 / IEC 60068-1	40 / 125 / 56
Operating temperature		-40°C ... +125°C
MECHANICAL CHARACTERISTICS		
IP degree of protection	DIN EN 60529 / IEC 60529	IP 65
Insertion and withdrawal force	DIN EN 60512-13-2, Test 13b / IEC 60512-13-2, Test 13b	≤ 22 N
Mechanical lifetime	DIN EN 60512-9-1, Test 9a	≥ 500 Steckzyklen
Strain relief		Cable retention
MATERIALS		
Contact plating		silver plated / gold plated
Housing		Polyamid 6.6
Gasket		Neoprene
Dielectric material		Polyamid 6.6
FURTHER CHARACTERISTICS		
Termination		crimp
Wire gauge		0,09 - 1,0 mm ²
Wire gauge (AWG)		28 - 18
Flammability	UL 94	V-0
Locking		Bayonet



3964



E63093



48932

Circular Connectors C 16-3 Female cable connector size 1; straight, No. of contacts 17 + PE, 100 V, 6 A

Part No. C016 10E017 002 1

Series Circular Connectors C 16-3

Subseries Circular Connector C 16-3



View represents all available contact positions.

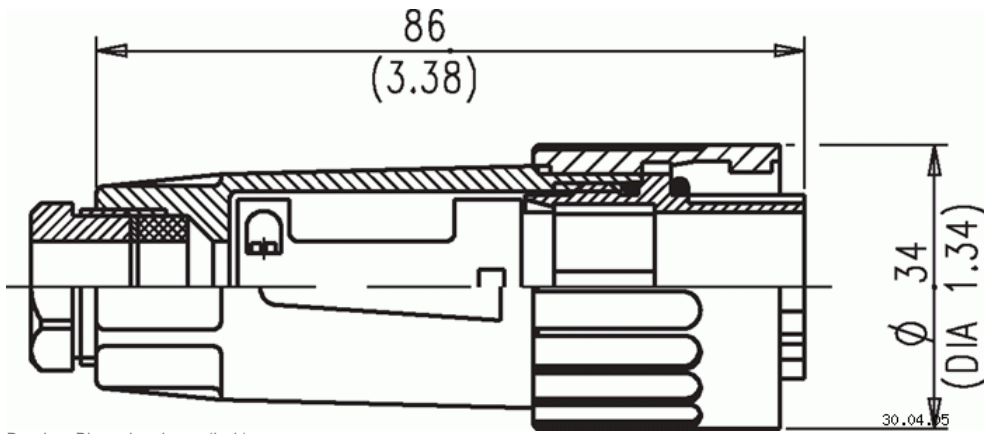

Drawing Dimensions in mm (Inch)

Circular Connectors C 16-3 Female cable connector size 1; straight, No. of contacts 17 + PE, 100 V, 6 A

Part No. C016 10E017 002 1

Series Circular Connectors C 16-3

Subseries Circular Connector C 16-3



View represents all available contact positions.

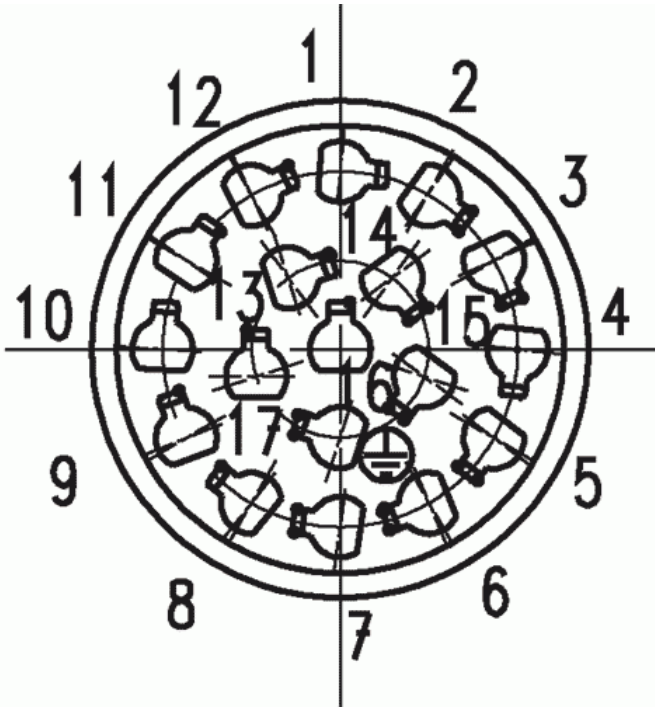

Contact arrangement

30.04.05