

Copying of this document and giving it to others and the use or communication of the contents thereof, are forbidden without express authority. Offenders are liable to the payment of damages. All rights are reserved in the event of the grant of a patent or the registration of the utility model or design.

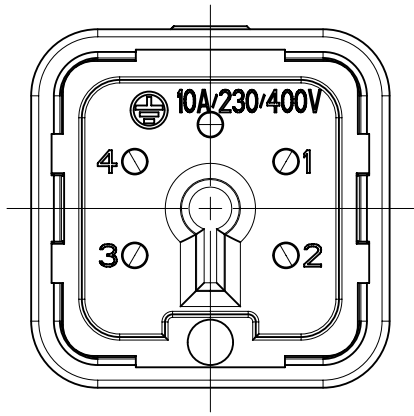

Ansicht von hinten
view from behind

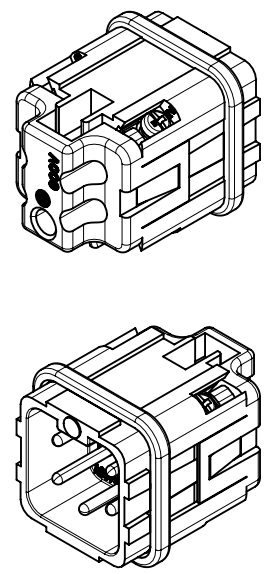
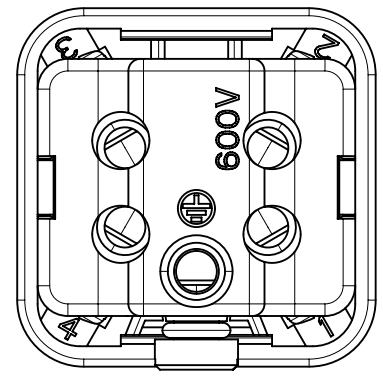
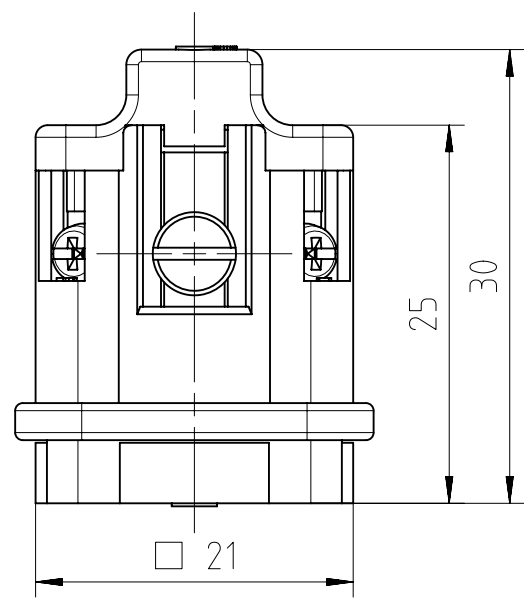

Alle technischen Daten wurden unter Laborbedingungen ermittelt und können im Praxisbetrieb abweichen.
 Es handelt sich bei den Angaben weder um Beschaffenheits- noch um Haltbarkeitsgarantien.
 All technical data have been measured in a laboratory environment and can be different during practical usage of the product. Any product information is for descriptive usage only and not legally binding; particularly the information does not constitute or provide any legal guarantees ("Beschaffenheitsgarantie" or "Haltbarkeitsgarantie").

Weitergabe sowie Vervielfältigung dieser Unterlage, Verwertung und Mitteilung ihres Inhalts nicht gestattet, soweit nicht ausdrücklich zugestanden. Zuwiderhandlungen verpflichten zu Schadensersatz. Alle Rechte für den Fall der Patenterteilung oder Gebrauchsmuster-Eintragung vorbehalten.

Gewicht (errechnet) / Calc WT: 15,56 g		Zul. Abw./Tolerances:		Maßstab / Scale: 2:1 (1:1)		A4			
Prüfmaß / Testdimension		ISO 2768-m				CUSTOMER DRAWING			
Teileindex / Partindexnumber:									
Bagatelle change:						Stifteinsatz 4-Pol + PE pin insert 4 pole + PE			
		Gez. 16.10.2015							
		Drawn JHOENNIGE2							
		Status Released							
		Gepr. 27.11.2018				M C146 10A004 002 4			
		Checked MBERTSCH							
05	201800446	27.11.2018	PWÖLF	Amphenol Tuchel Industrial GmbH		Blatt / Sheet 1		1 Bl.	
04	201600656	20.09.2016	JHÖNN						
03	201500015	16.10.2015	JHÖNN						
Index	Anderung / Description	Datum / Date	Name			Ers. f. / Replacement for: M-C146 10A004 002 4 Rev02			