

CD4094B Types

CMOS 8-Stage Shift-and-Store Bus Register

High-Voltage Types (20-Volt Rating)

■ CD4094B is an 8-stage serial shift register having a storage latch associated with each stage for strobing data from the serial input to parallel buffered 3-state outputs. The parallel outputs may be connected directly to common bus lines. Data is shifted on positive clock transitions. The data in each shift register stage is transferred to the storage register when the STROBE input is high. Data in the storage register appears at the outputs whenever the OUTPUT-ENABLE signal is high.

Two serial outputs are available for cascading a number of CD4094B devices. Data is available at the Q_S serial output terminal on positive clock edges to allow for high-speed operation in cascaded systems in which the clock rise time is fast. The same serial information, available at the Q_S terminal on the next negative clock edge, provides a means for cascading CD4094B devices when the clock rise time is slow.

The CD4094B types are supplied in 16-lead hermetic dual-in-line ceramic packages (F3A suffix), 16-lead dual-in-line plastic packages (E suffix), 16-lead small-outline packages (NSR suffix), and 16-lead thin shrink small-outline packages (PW and PWR suffixes).

Features:

- 3-state parallel outputs for connection to common bus
- Separate serial outputs synchronous to both positive and negative clock edges for cascading
- Medium speed operation - 5 MHz at 10 V (typ.)
- Standardized, symmetrical output characteristics
- 100% tested for quiescent current at 20 V
- Maximum input current of 1 μ A at 18 V over full package-temperature range; 100 nA at 18 V and 25°C
- Noise margin (full package temperature range):
1 V at V_{DD} = 5 V 2 V at V_{DD} = 10 V
2.5 V at V_{DD} = 15 V
- 5-V, 10-V, and 15-V parametric ratings
- Meets all requirements of JEDEC Tentative Standard No. 13B, "Standard Specifications for Description of 'B' Series CMOS Devices"

Applications:

- Serial-to-parallel data conversion
- Remote control holding register
- Dual-rank shift, hold, and bus applications

MAXIMUM RATINGS, Absolute-Maximum Values:

| | |
|---|-------------------------------------|
| DC SUPPLY-VOLTAGE RANGE, (V _{DD}) | -0.5V to +20V |
| Voltages referenced to V _{SS} Terminal) | |
| INPUT VOLTAGE RANGE, ALL INPUTS | -0.5V to V _{DD} + 0.5V |
| DC INPUT CURRENT, ANY ONE INPUT | ±10mA |
| POWER DISSIPATION PER PACKAGE (P _D): | |
| For T _A = -55°C to +100°C | 500mW |
| For T _A = +100°C to +125°C | Derate Linearly at 12mW/°C to 200mW |
| DEVICE DISSIPATION PER OUTPUT TRANSISTOR | |
| FOR T _A = FULL PACKAGE-TEMPERATURE RANGE (All Package Types) | 100mW |
| OPERATING-TEMPERATURE RANGE (T _A) | -55°C to +125°C |
| STORAGE TEMPERATURE RANGE (T _{stg}) | -65°C to +150°C |
| LEAD TEMPERATURE (DURING SOLDERING): | |
| At distance 1/16 ± 1/32 inch (1.59 ± 0.79mm) from case for 10s max | +265°C |

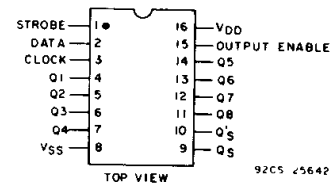
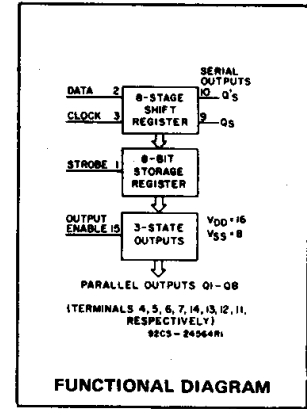

Fig. 1 - Terminal assignment.

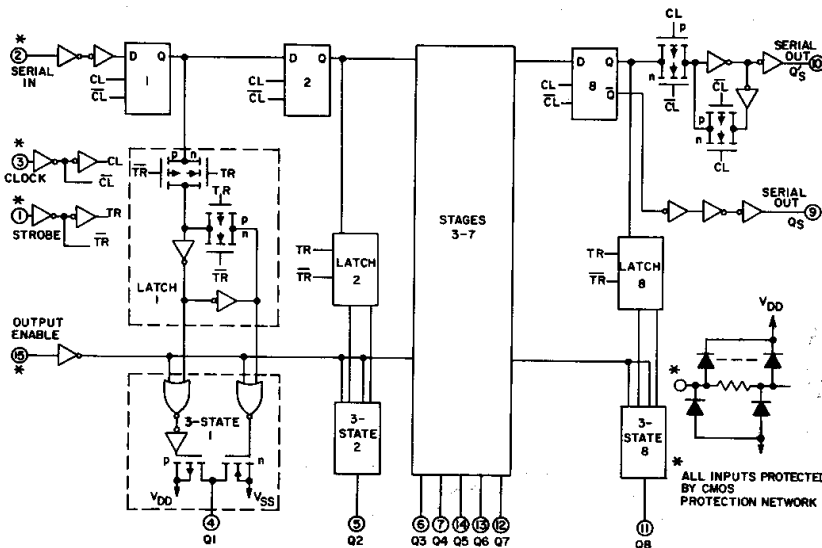

Fig. 2 - CD4094B Logic diagram.

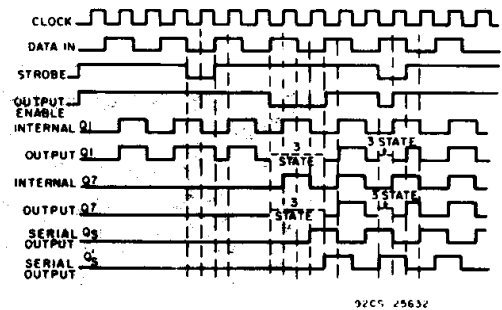

Fig. 3 - Timing diagram.

CD4094B Types

RECOMMENDED OPERATING CONDITIONS at $T_A = 25^\circ\text{C}$, Except as Noted.
 For maximum reliability, nominal operating conditions should be selected so that operation is always within the following ranges:

| CHARACTERISTIC | VDD (V) | LIMITS | | UNITS |
|--|---------|--------|------|---------------|
| | | MIN. | MAX. | |
| Supply-Voltage Range (For T_A =Full Package-Temperature Range) | | 3 | 18 | V |
| Data Setup Time, t_S | 5 | 125 | — | ns |
| | 10 | 55 | — | |
| | 15 | 35 | — | |
| Clock Pulse Width, t_W | 5 | 200 | — | ns |
| | 10 | 100 | — | |
| | 15 | 83 | — | |
| Clock Input Frequency, f_{CL} | 5 | | 1.25 | MHz |
| | 10 | dc | 2.5 | |
| | 15 | | 3 | |
| Clock Input Rise or Fall time, t_{rCL}, t_{fCL} * | 5 | | 15 | μs |
| | 10 | — | 5 | |
| | 15 | | 5 | |
| Strobe Pulse Width, t_W | 5 | 200 | — | ns |
| | 10 | 80 | — | |
| | 15 | 70 | — | |

*If more than one unit is cascaded t_{fCL} (for Q_S only) should be made less than or equal to the sum of the fixed propagation delay at 50 pF and the transition time of the output driving stage for the estimated capacitive load.

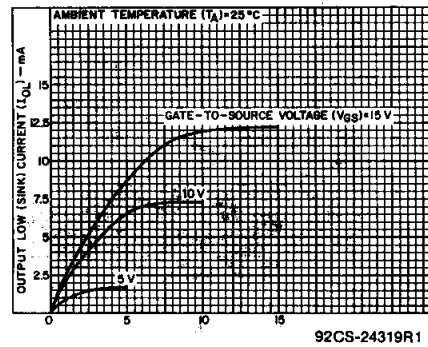

Fig. 5 - Minimum output low (sink) current characteristics.

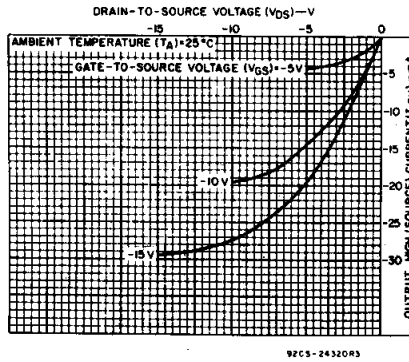

Fig. 6 - Typical output high (source) current characteristics.

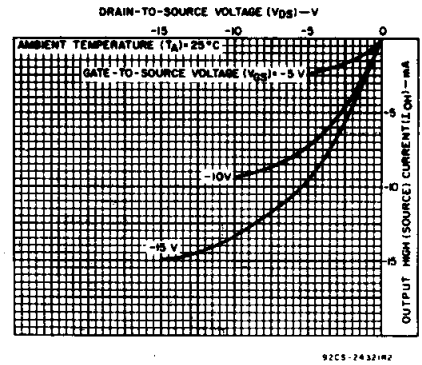

Fig. 7 - Minimum output high (source) current characteristics.

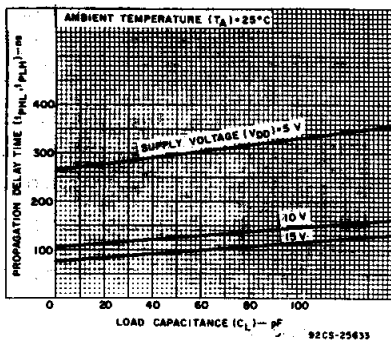

Fig. 8 - Clock-to-serial output Q_S propagation delay vs C_L .

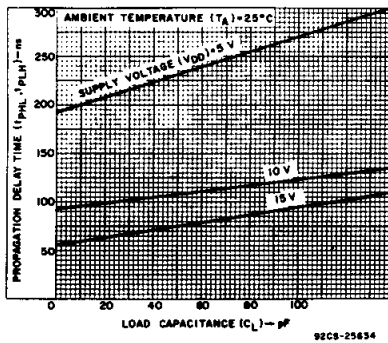

Fig. 9 - Clock-to-serial output Q'_S propagation delay vs C_L .

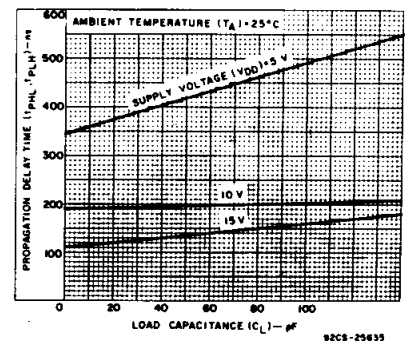

Fig. 10 - Clock-to-parallel output propagation delay vs C_L .

TRUTH TABLE

| CL [▲] | Output Enable | Strobe | Data | Parallel Outputs | | Serial Outputs | |
|-----------------|---------------|--------|------|------------------|------------------|----------------|----|
| | | | | Q1 | Q2 | Q3* | Q4 |
| 0 | X | X | X | OC | OC | Q7 | NC |
| 0 | X | X | X | OC | OC | NC | Q7 |
| 1 | 0 | X | X | NC | NC | Q7 | NC |
| 1 | 1 | 0 | 0 | Q _{N-1} | Q _{N-1} | Q7 | NC |
| 1 | 1 | 1 | 1 | Q _{N-1} | Q _{N-1} | Q7 | NC |
| 1 | 1 | 1 | 1 | NC | NC | NC | Q7 |

▲ = Level Change
 X = Don't Care
 NC = No Change
 OC = Open Circuit
 Logic 1 \equiv High
 Logic 0 \equiv Low

* At the positive clock edge information in the 7th shift register stage is transferred to the 8th register stage and the Q_S output.

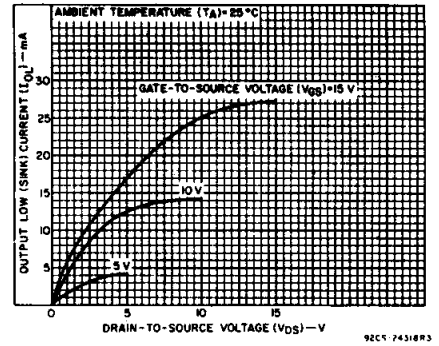

Fig. 4 - Typical output low (sink) current characteristics.

3
COMMERCIAL CMOS
HIGH VOLTAGE ICs

CD4094B Types

STATIC ELECTRICAL CHARACTERISTICS

| CHARACTERISTIC | CONDITIONS | | | LIMITS AT INDICATED TEMPERATURES (°C) | | | | | | | UNITS |
|--|--------------------|---------------------|---------------------|---------------------------------------|-------|-------|-------|-------|-------------------|------|-------|
| | V _O (V) | V _{IN} (V) | V _{DD} (V) | -55 | -40 | +85 | +125 | +25 | | | |
| | | | | | | | | Min. | Typ. | Max. | |
| Quiescent Device Current, I _{DD} Max. | - | 0.5 | 5 | 5 | 5 | 150 | 150 | - | 0.04 | 5 | μA |
| | - | 0.10 | 10 | 10 | 10 | 300 | 300 | - | 0.04 | 10 | |
| | - | 0.15 | 15 | 20 | 20 | 600 | 600 | - | 0.04 | 20 | |
| | - | 0.20 | 20 | 100 | 100 | 3000 | 3000 | - | 0.08 | 100 | |
| Output Low (Sink) Current, I _{OL} Min. | 0.4 | 0.5 | 5 | 0.64 | 0.61 | 0.42 | 0.36 | 0.51 | 1 | - | mA |
| | 0.5 | 0.10 | 10 | 1.6 | 1.5 | 1.1 | 0.9 | 1.3 | 2.6 | - | |
| | 1.5 | 0.15 | 15 | 4.2 | 4 | 2.8 | 2.4 | 3.4 | 6.8 | - | |
| Output High (Source) Current, I _{OH} Min. | 4.6 | 0.5 | 5 | -0.64 | -0.61 | -0.42 | -0.36 | -0.51 | -1 | - | mA |
| | 2.5 | 0.5 | 5 | -2 | -1.8 | -1.3 | -1.15 | -1.6 | -3.2 | - | |
| | 9.5 | 0.10 | 10 | -1.6 | -1.5 | -1.1 | -0.9 | -1.3 | -2.6 | - | |
| | 13.5 | 0.15 | 15 | -4.2 | -4 | -2.8 | -2.4 | -3.4 | -6.8 | - | |
| Output Voltage: Low-Level, V _{OL} Max. | - | 0.5 | 5 | 0.05 | | | | - | 0 | 0.05 | V |
| | - | 0.10 | 10 | 0.05 | | | | - | 0 | 0.05 | |
| | - | 0.15 | 15 | 0.05 | | | | - | 0 | 0.05 | |
| Output Voltage: High-Level, V _{OH} Min. | - | 0.5 | 5 | 4.95 | | | | 4.95 | 5 | - | V |
| | - | 0.10 | 10 | 9.95 | | | | 9.95 | 10 | - | |
| | - | 0.15 | 15 | 14.95 | | | | 14.95 | 15 | - | |
| | - | 0.15 | 15 | 14.95 | | | | 14.95 | 15 | - | |
| Input Low Voltage, V _{IL} Max. | 0.5, 4.5 | - | 5 | 1.5 | | | | - | - | 1.5 | V |
| | 1.9 | - | 10 | 3 | | | | - | - | 3 | |
| | 1.5, 13.5 | - | 15 | 4 | | | | - | - | 4 | |
| Input High Voltage, V _{IH} Min. | 0.5, 4.5 | - | 5 | 3.5 | | | | 3.5 | - | - | V |
| | 1.9 | - | 10 | 7 | | | | 7 | - | - | |
| | 1.5, 13.5 | - | 15 | 11 | | | | 11 | - | - | |
| Input Current I _{IN} Max. | - | 0.18 | 18 | ±0.1 | ±0.1 | ±1 | ±1 | - | ±10 ⁻⁵ | ±0.1 | μA |
| 3-State Output Leakage Current I _{OUT} Max. | 0.18 | 0.18 | 18 | ±0.4 | ±0.4 | ±12 | ±12 | - | ±10 ⁻⁴ | ±0.4 | μA |

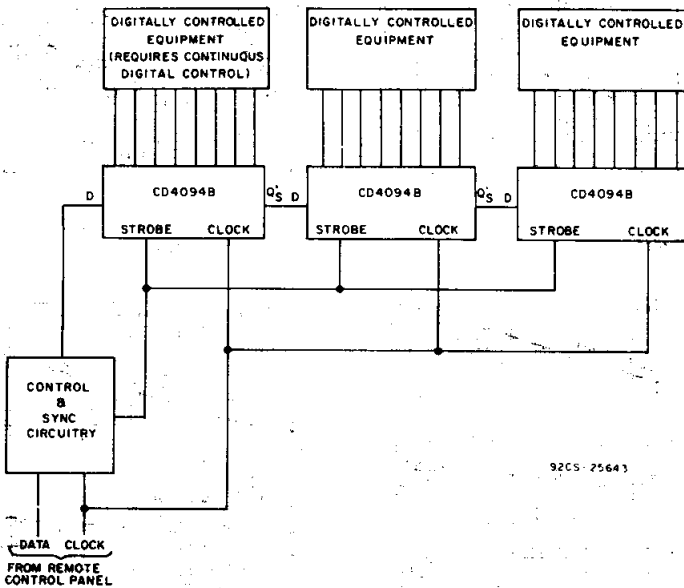

Fig. 14 - Remote control holding register.

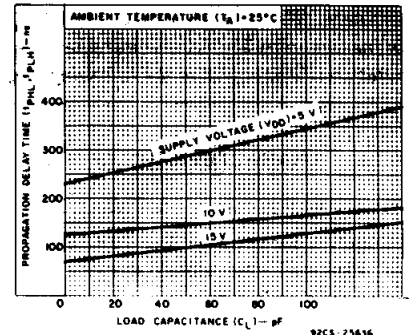

Fig. 11 - Strobe-to-parallel output propagation delay vs. C_L.

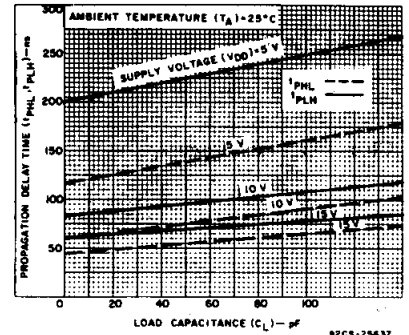

Fig. 12 - Output enable-to-parallel output propagation delay vs. C_L.

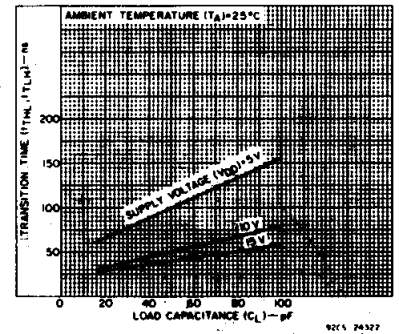

Fig. 13 - Typical transition time vs. load capacitance.

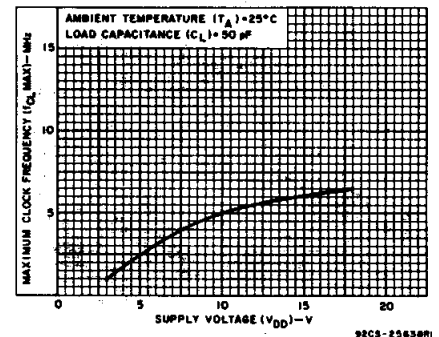

Fig. 15 - Typical maximum-clock-frequency vs. supply voltage.

CD4094B Types

DYNAMIC ELECTRICAL CHARACTERISTICS

At $T_A = 25^\circ\text{C}$; Input $t_r, t_f = 20\text{ ns}$, $C_L = 50\text{ pF}$, $R_L = 200\text{ k}\Omega$

| CHARACTERISTIC | VDD (V) | LIMITS | | | UNITS |
|--|---------|--------|------|------|---------------|
| | | MIN. | TYP. | MAX. | |
| Propagation Delay Time, t_{PHL}, t_{PLH} Clock to Serial Output Q_S | 5 | — | 300 | 600 | ns |
| | 10 | — | 125 | 250 | |
| | 15 | — | 95 | 190 | |
| Clock to Serial Output Q'_S | 5 | — | 230 | 460 | ns |
| | 10 | — | 110 | 220 | |
| | 15 | — | 75 | 150 | |
| Clock to Parallel Output | 5 | — | 420 | 840 | ns |
| | 10 | — | 195 | 390 | |
| | 15 | — | 135 | 270 | |
| Strobe to Parallel Output | 5 | — | 290 | 580 | ns |
| | 10 | — | 145 | 290 | |
| | 15 | — | 100 | 200 | |
| Output Enable to Parallel Output: t_{PHZ}, t_{PZH} | 5 | — | 140 | 280 | ns |
| | 10 | — | 60 | 120 | |
| | 15 | — | 45 | 90 | |
| t_{PLZ}, t_{PZL} | 5 | — | 100 | 200 | ns |
| | 10 | — | 50 | 100 | |
| | 15 | — | 40 | 80 | |
| Minimum Strobe Pulse Width, t_W | 5 | — | 100 | 200 | ns |
| | 10 | — | 40 | 80 | |
| | 15 | — | 35 | 70 | |
| Minimum Clock Pulse Width, t_W | 5 | — | 100 | 200 | ns |
| | 10 | — | 50 | 100 | |
| | 15 | — | 40 | 83 | |
| Minimum Data Setup Time, t_S | 5 | — | 60 | 125 | ns |
| | 10 | — | 30 | 55 | |
| | 15 | — | 20 | 35 | |
| Transition Time; t_{THL}, t_{TLH} | 5 | — | 100 | 200 | ns |
| | 10 | — | 50 | 100 | |
| | 15 | — | 40 | 80 | |
| Maximum Clock Input Rise or Fall Time, t_{rCL}, t_{fCL} | 5 | 15 | — | — | μs |
| | 10 | 5 | — | — | |
| | 15 | 5 | — | — | |
| Maximum Clock Input Frequency, f_{CL} | 5 | 1.25 | 2.5 | — | MHz |
| | 10 | 2.5 | 5 | — | |
| | 15 | 3 | 6 | — | |
| Input Capacitance C_{iN} (Any Input) | — | — | 5 | 7.5 | pF |

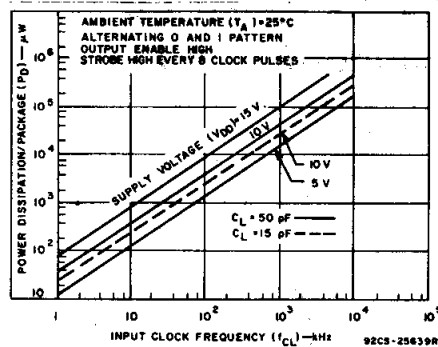

Fig. 16 — Dynamic power dissipation vs input clock frequency.

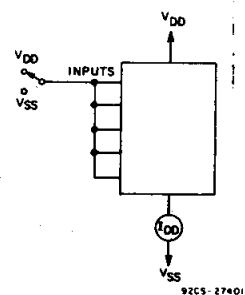

Fig. 17 — Quiescent device current test circuit.

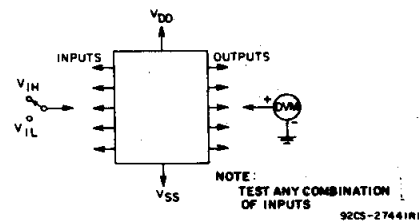

Fig. 18 — Input voltage test circuit.

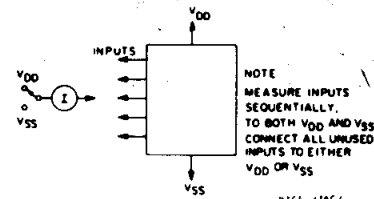
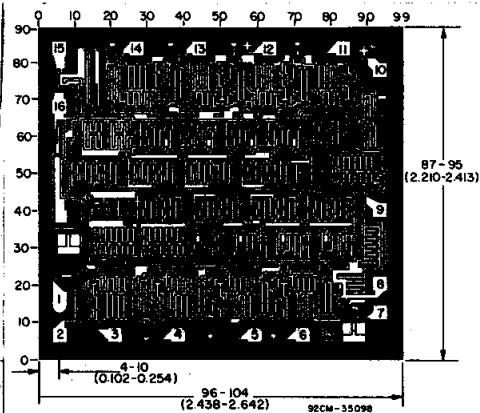

Fig. 19 — Input current test circuit.



Dimensions and Pad Layout for CD4094B Chip.

Dimensions in parentheses are in millimeters and are derived from the basic inch dimensions as indicated. Grid graduations are in mils (10^{-3} inch).

3
COMMERCIAL CMOS
HIGH VOLTAGE ICs

PACKAGING INFORMATION

| Orderable Device | Status ⁽¹⁾ | Package Type | Package Drawing | Pins | Package Qty | Eco Plan ⁽²⁾ | Lead/Ball Finish | MSL Peak Temp ⁽³⁾ |
|------------------|-----------------------|--------------|-----------------|------|-------------|-------------------------|------------------|--|
| 7702501EA | ACTIVE | CDIP | J | 16 | 1 | TBD | Call TI | Level-NC-NC-NC |
| CD4094BE | ACTIVE | PDIP | N | 16 | 25 | Pb-Free (RoHS) | CU NIPDAU | Level-NC-NC-NC |
| CD4094BF | ACTIVE | CDIP | J | 16 | 1 | TBD | Call TI | Level-NC-NC-NC |
| CD4094BF3A | ACTIVE | CDIP | J | 16 | 1 | TBD | Call TI | Level-NC-NC-NC |
| CD4094BNSR | ACTIVE | SO | NS | 16 | 2000 | Pb-Free (RoHS) | CU NIPDAU | Level-2-260C-1 YEAR/ Level-1-235C-UNLIM |
| CD4094BNSRE4 | ACTIVE | SO | NS | 16 | 2000 | TBD | Call TI | Call TI |
| CD4094BPW | ACTIVE | TSSOP | PW | 16 | 90 | Pb-Free (RoHS) | CU NIPDAU | Level-1-250C-UNLIM |
| CD4094BPWE4 | ACTIVE | TSSOP | PW | 16 | 90 | Pb-Free (RoHS) | CU NIPDAU | Level-1-250C-UNLIM |
| CD4094BPWR | ACTIVE | TSSOP | PW | 16 | 2000 | Pb-Free (RoHS) | CU NIPDAU | Level-1-250C-UNLIM |
| CD4094BPWRE4 | ACTIVE | TSSOP | PW | 16 | 2000 | Pb-Free (RoHS) | CU NIPDAU | Level-1-250C-UNLIM |

⁽¹⁾ The marketing status values are defined as follows:

ACTIVE: Product device recommended for new designs.

LIFEBUY: TI has announced that the device will be discontinued, and a lifetime-buy period is in effect.

NRND: Not recommended for new designs. Device is in production to support existing customers, but TI does not recommend using this part in a new design.

PREVIEW: Device has been announced but is not in production. Samples may or may not be available.

OBSELETE: TI has discontinued the production of the device.

⁽²⁾ Eco Plan - The planned eco-friendly classification: Pb-Free (RoHS) or Green (RoHS & no Sb/Br) - please check <http://www.ti.com/productcontent> for the latest availability information and additional product content details.

TBD: The Pb-Free/Green conversion plan has not been defined.

Pb-Free (RoHS): TI's terms "Lead-Free" or "Pb-Free" mean semiconductor products that are compatible with the current RoHS requirements for all 6 substances, including the requirement that lead not exceed 0.1% by weight in homogeneous materials. Where designed to be soldered at high temperatures, TI Pb-Free products are suitable for use in specified lead-free processes.

Green (RoHS & no Sb/Br): TI defines "Green" to mean Pb-Free (RoHS compatible), and free of Bromine (Br) and Antimony (Sb) based flame retardants (Br or Sb do not exceed 0.1% by weight in homogeneous material)

⁽³⁾ MSL, Peak Temp. -- The Moisture Sensitivity Level rating according to the JEDEC industry standard classifications, and peak solder temperature.

Important Information and Disclaimer:The information provided on this page represents TI's knowledge and belief as of the date that it is provided. TI bases its knowledge and belief on information provided by third parties, and makes no representation or warranty as to the accuracy of such information. Efforts are underway to better integrate information from third parties. TI has taken and continues to take reasonable steps to provide representative and accurate information but may not have conducted destructive testing or chemical analysis on incoming materials and chemicals. TI and TI suppliers consider certain information to be proprietary, and thus CAS numbers and other limited information may not be available for release.

In no event shall TI's liability arising out of such information exceed the total purchase price of the TI part(s) at issue in this document sold by TI to Customer on an annual basis.

J (R-GDIP-T**)

14 LEADS SHOWN

CERAMIC DUAL IN-LINE PACKAGE

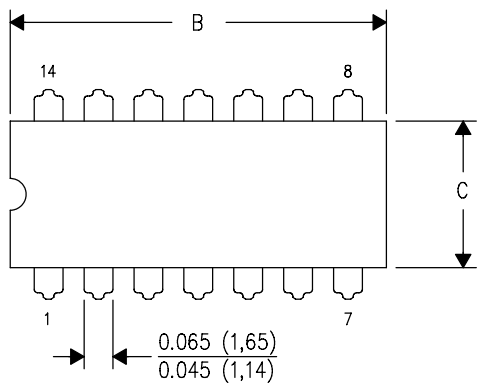

| DIM \ PINS ** | 14 | 16 | 18 | 20 |
|---------------|------------------------|------------------------|------------------------|------------------------|
| A | 0.300 (7,62) BSC | 0.300 (7,62) BSC | 0.300 (7,62) BSC | 0.300 (7,62) BSC |
| B MAX | 0.785 (19,94) | .840 (21,34) | 0.960 (24,38) | 1.060 (26,92) |
| B MIN | — | — | — | — |
| C MAX | 0.300 (7,62) | 0.300 (7,62) | 0.310 (7,87) | 0.300 (7,62) |
| C MIN | 0.245 (6,22) | 0.245 (6,22) | 0.220 (5,59) | 0.245 (6,22) |



4040083/F 03/03

- NOTES:
- A. All linear dimensions are in inches (millimeters).
 - B. This drawing is subject to change without notice.
 - C. This package is hermetically sealed with a ceramic lid using glass frit.
 - D. Index point is provided on cap for terminal identification only on press ceramic glass frit seal only.
 - E. Falls within MIL STD 1835 GDIP1-T14, GDIP1-T16, GDIP1-T18 and GDIP1-T20.

N (R-PDIP-T**)

PLASTIC DUAL-IN-LINE PACKAGE

16 PINS SHOWN



4040049/E 12/2002

- NOTES:
- A. All linear dimensions are in inches (millimeters).
 - B. This drawing is subject to change without notice.
 - (C) Falls within JEDEC MS-001, except 18 and 20 pin minimum body length (Dim A).
 - (D) The 20 pin end lead shoulder width is a vendor option, either half or full width.

MECHANICAL DATA

NS (R-PDSO-G**)

PLASTIC SMALL-OUTLINE PACKAGE

14-PINS SHOWN



- NOTES:
- A. All linear dimensions are in millimeters.
 - B. This drawing is subject to change without notice.
 - C. Body dimensions do not include mold flash or protrusion, not to exceed 0,15.

PW (R-PDSO-G**)

PLASTIC SMALL-OUTLINE PACKAGE

14 PINS SHOWN



- NOTES: A. All linear dimensions are in millimeters.
 B. This drawing is subject to change without notice.
 C. Body dimensions do not include mold flash or protrusion not to exceed 0,15.
 D. Falls within JEDEC MO-153

IMPORTANT NOTICE

Texas Instruments Incorporated and its subsidiaries (TI) reserve the right to make corrections, modifications, enhancements, improvements, and other changes to its products and services at any time and to discontinue any product or service without notice. Customers should obtain the latest relevant information before placing orders and should verify that such information is current and complete. All products are sold subject to TI's terms and conditions of sale supplied at the time of order acknowledgment.

TI warrants performance of its hardware products to the specifications applicable at the time of sale in accordance with TI's standard warranty. Testing and other quality control techniques are used to the extent TI deems necessary to support this warranty. Except where mandated by government requirements, testing of all parameters of each product is not necessarily performed.

TI assumes no liability for applications assistance or customer product design. Customers are responsible for their products and applications using TI components. To minimize the risks associated with customer products and applications, customers should provide adequate design and operating safeguards.

TI does not warrant or represent that any license, either express or implied, is granted under any TI patent right, copyright, mask work right, or other TI intellectual property right relating to any combination, machine, or process in which TI products or services are used. Information published by TI regarding third-party products or services does not constitute a license from TI to use such products or services or a warranty or endorsement thereof. Use of such information may require a license from a third party under the patents or other intellectual property of the third party, or a license from TI under the patents or other intellectual property of TI.

Reproduction of information in TI data books or data sheets is permissible only if reproduction is without alteration and is accompanied by all associated warranties, conditions, limitations, and notices. Reproduction of this information with alteration is an unfair and deceptive business practice. TI is not responsible or liable for such altered documentation.

Resale of TI products or services with statements different from or beyond the parameters stated by TI for that product or service voids all express and any implied warranties for the associated TI product or service and is an unfair and deceptive business practice. TI is not responsible or liable for any such statements.

Following are URLs where you can obtain information on other Texas Instruments products and application solutions:

| Products | | Applications | |
|------------------|--|---------------------|--|
| Amplifiers | amplifier.ti.com | Audio | www.ti.com/audio |
| Data Converters | dataconverter.ti.com | Automotive | www.ti.com/automotive |
| DSP | dsp.ti.com | Broadband | www.ti.com/broadband |
| Interface | interface.ti.com | Digital Control | www.ti.com/digitalcontrol |
| Logic | logic.ti.com | Military | www.ti.com/military |
| Power Mgmt | power.ti.com | Optical Networking | www.ti.com/opticalnetwork |
| Microcontrollers | microcontroller.ti.com | Security | www.ti.com/security |
| | | Telephony | www.ti.com/telephony |
| | | Video & Imaging | www.ti.com/video |
| | | Wireless | www.ti.com/wireless |

Mailing Address: Texas Instruments
Post Office Box 655303 Dallas, Texas 75265