

CMOS Dual 64-Stage Static Shift Register

CD4517B Types

High-Voltage Types (20-Volt Rating)

■ CD4517B dual 64-stage static shift register consists of two independent registers each having a clock, data, and write enable input and outputs accessible at taps following the 16th, 32nd, 48th, and 64th stages. These taps also serve as input points allowing data to be inputted at the 17th, 33rd, and 49th stages when the write enable input is a logic 1 and the clock goes through a low-to-high transition. The truth table indicates how the clock and write enable inputs control the operation of the CD4517B. Inputs at the intermediate taps allow entry of 64 bits into the register with 16 clock pulses. The 3-state outputs permit connection of this device to an external bus.

The CD4517B is supplied in 16-lead hermetic dual-in-line ceramic packages (D and F suffixes), 16-lead dual-in-line plastic packages (E suffix), and in chip form (H suffix).

Features:

- Low quiescent current – 10 nA/pkg (typ.) at $V_{DD} = 5\text{ V}$
- Clock frequency 12 MHz (typ.) at $V_{DD} = 10\text{ V}$
- Schmitt trigger clock inputs allow operation with very slow clock rise and fall times
- Capable of driving two low-power TTL loads, one low-power Schottky TTL load, or two HTL loads
- Three-state outputs
- 100% tested for quiescent current at 20 V
- Standardized, symmetrical output characteristics
- 5-V, 10-V and 15-V parametric ratings
- Meets all requirements of JEDEC Tentative Standard No. 13B, "Standard Specifications for Description of 'B' Series CMOS Devices"

Applications:

- Time-delay circuits
- Scratch-pad memories
- General-purpose serial shift-register applications

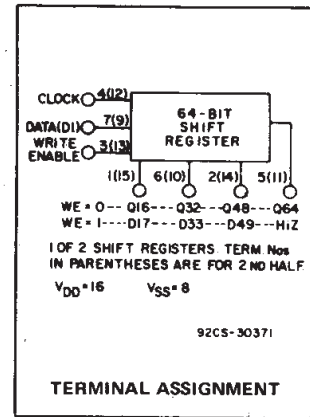
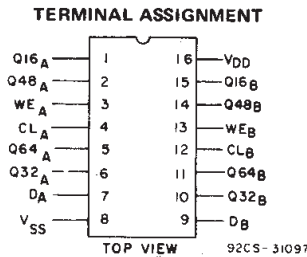

MAXIMUM RATINGS, Absolute-Maximum Values:

DC SUPPLY-VOLTAGE RANGE, (V_{DD}) -0.5V to +20V
Voltages referenced to V_{SS} Terminal) -0.5V to $V_{DD} + 0.5\text{ V}$
INPUT VOLTAGE RANGE, ALL INPUTS -0.5V to $V_{DD} + 0.5\text{ V}$
DC INPUT CURRENT, ANY ONE INPUT $\pm 10\text{ mA}$
POWER DISSIPATION PER PACKAGE (P_D): $\pm 10\text{ mA}$
For $T_A = -55^\circ\text{C}$ to $+100^\circ\text{C}$ 500mW
For $T_A = +100^\circ\text{C}$ to $+125^\circ\text{C}$ Derate Linearly at 12mW/ $^\circ\text{C}$ to 200mW
DEVICE DISSIPATION PER OUTPUT TRANSISTOR
FOR $T_A = \text{FULL PACKAGE-TEMPERATURE RANGE (All Package Types)}$ 100mW
OPERATING-TEMPERATURE RANGE (T_A) -55°C to $+125^\circ\text{C}$
STORAGE TEMPERATURE RANGE (T_{stg}) -65°C to $+150^\circ\text{C}$
LEAD TEMPERATURE (DURING SOLDERING):
At distance 1/16 \pm 1/32 inch (1.59 \pm 0.79mm) from case for 10s max $+265^\circ\text{C}$

RECOMMENDED OPERATING CONDITIONS

For maximum reliability, nominal operating conditions should be selected so that operation is always within the following ranges:

CHARACTERISTIC	LIMITS		UNITS
	MIN.	MAX.	
Supply-Voltage Range (For $T_A = \text{Full Package Temperature Range}$)	3	18	V

TRUTH TABLE

Clock	Write Enable	Data	Stage 16 Tap	Stage 32 Tap	Stage 48 Tap	Stage 64 Tap
0	0	X	Q16	Q32	Q48	Q64
0	1	X	Z	Z	Z	Z
1	0	X	Q16	Q32	Q48	Q64
1	1	X	Z	Z	Z	Z
~	0	DI In	Q16	Q32	Q48	Q64
~	1	DI In	D17 In	D33 In	D49 In	Z
~	0	X	Q16	Q32	Q48	Q64
~	1	X	Z	Z	Z	Z

X = Don't Care

Z = High Impedance

3
COMMERCIAL CMOS
HIGH VOLTAGE ICs

CD4517B Types

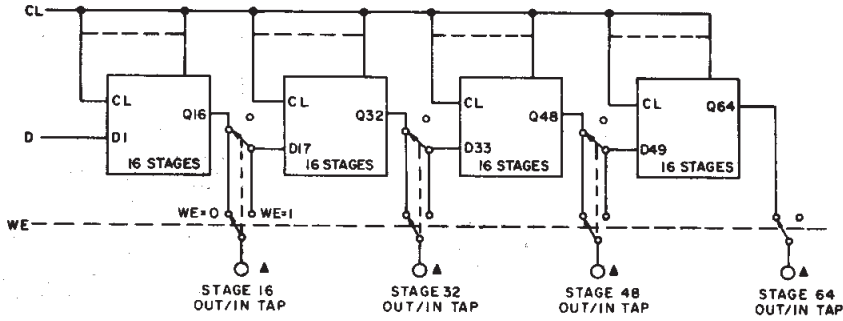

Fig. 1—CD4517B functional block diagram (one half).

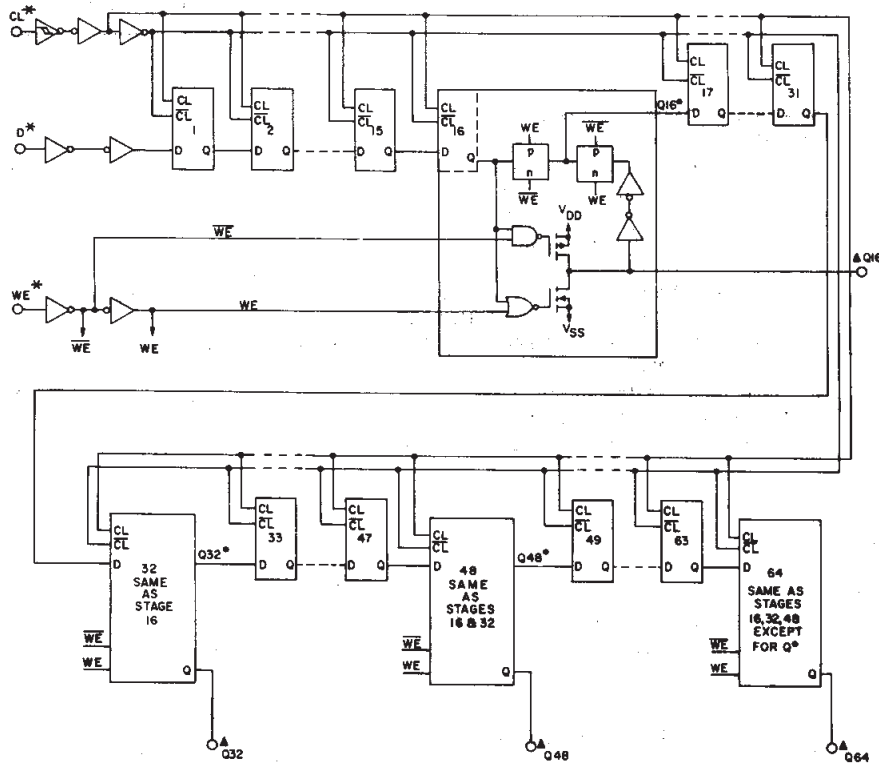

Fig. 2—CD4517B logic block diagram (one half).

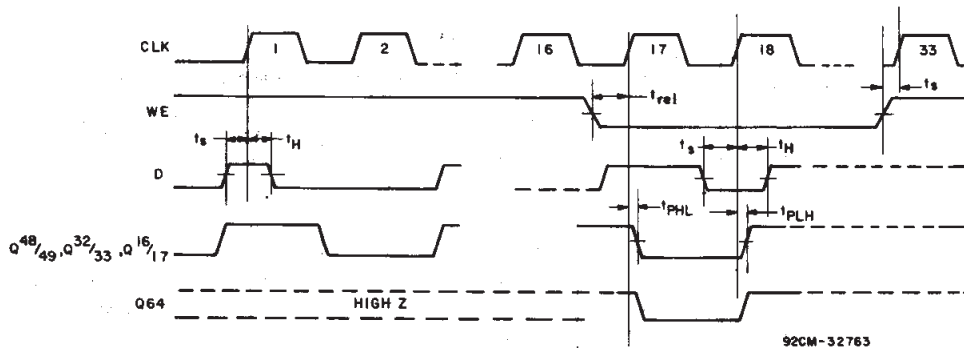
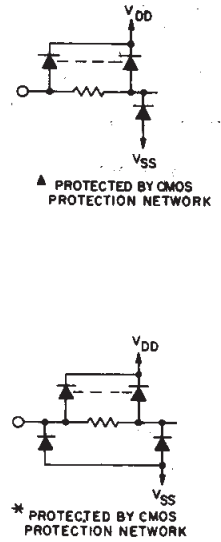

Fig. 3—Dynamic test waveforms.

CD4517B Types

STATIC ELECTRICAL CHARACTERISTICS

CHARACTERISTIC	CONDITIONS			LIMITS AT INDICATED TEMPERATURES (°C)							UNITS
	V _O (V)	V _{IN} (V)	V _{DD} (V)	-55	-40	+85	+125	+25			
								Min.	Typ.	Max.	
Quiescent Device Current, I _{DD} Max.	-	0,5	5	5	5	150	150	-	0,04	5	μA
	-	0,10	10	10	10	300	300	-	0,04	10	
	-	0,15	15	20	20	600	600	-	0,04	20	
	-	0,20	20	100	100	3000	3000	-	0,08	100	
Output Low (Sink) Current I _{OL} Min.	0,4	0,5	5	0,64	0,61	0,42	0,36	0,51	1	-	mA
	0,5	0,10	10	1,6	1,5	1,1	0,9	1,3	2,6	-	
	1,5	0,15	15	4,2	4	2,8	2,4	3,4	6,8	-	
Output High (Source) Current, I _{OH} Min.	4,6	0,5	5	-0,64	-0,61	-0,42	-0,36	-0,51	-1	-	mA
	2,5	0,5	5	-2	-1,8	-1,3	-1,15	-1,6	-3,2	-	
	9,5	0,10	10	-1,6	-1,5	-1,1	-0,9	-1,3	-2,6	-	
	13,5	0,15	15	-4,2	-4	-2,8	-2,4	-3,4	-6,8	-	
Output Voltage: Low-Level, V _{OL} Max.	-	0,5	5	0,05			-	0	0,05	-	V
	-	0,10	10	0,05			-	0	0,05	-	
	-	0,15	15	0,05			-	0	0,05	-	
Output Voltage: High-Level, V _{OH} Min.	-	0,5	5	4,95			4,95	5	-	-	V
	-	0,10	10	9,95			9,95	10	-	-	
	-	0,15	15	14,95			14,95	15	-	-	
Input Low Voltage V _{IL} Max.	0,5, 4,5	-	5	1,5			-	-	1,5	-	V
	1,9	-	10	3			-	-	3	-	
	1,5, 13,5	-	15	4			-	-	4	-	
Input High Voltage V _{IH} Min.	0,5, 4,5	-	5	3,5			3,5	-	-	-	V
	1,9	-	10	7			7	-	-	-	
	1,5, 13,5	-	15	11			11	-	-	-	
Input Current I _{IN} Max.	-	0,18	18	±0,1	±0,1	±1	±1	-	±10 ⁻⁵	±0,1	μA
3-State Output Leakage Current I _{OUT} Max.	0,18	0,18	18	±0,4	±0,4	±12	±12	-	±10 ⁻⁴	±0,4	μA

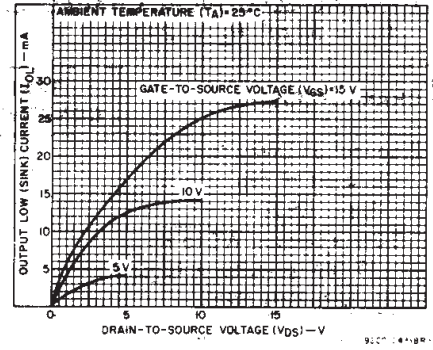

Fig. 4—Typical n-channel output low (sink) current characteristics.

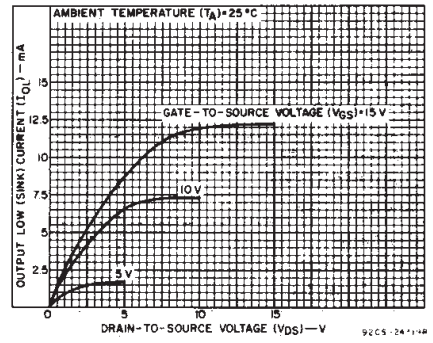

Fig. 5—Minimum n-channel output low (sink) current characteristics.

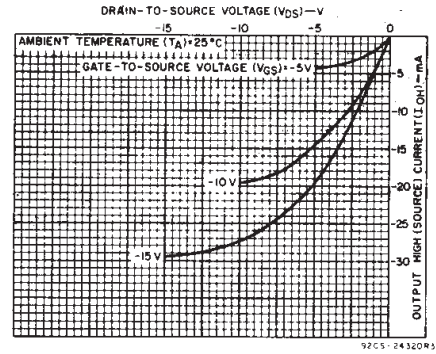

Fig. 6—Typical p-channel output high (source) current characteristics.

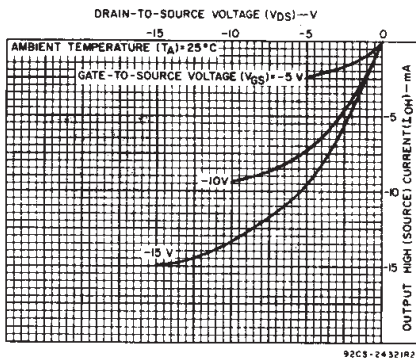

Fig. 7—Minimum p-channel output high (source) current characteristics.

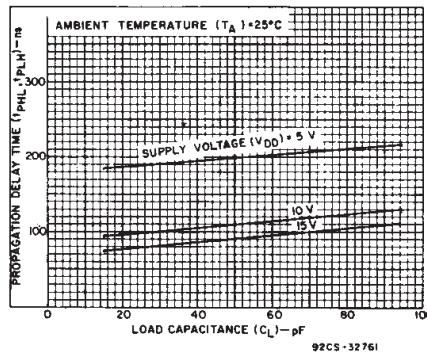

Fig. 8—Typical propagation delay time as a function of load capacitance.

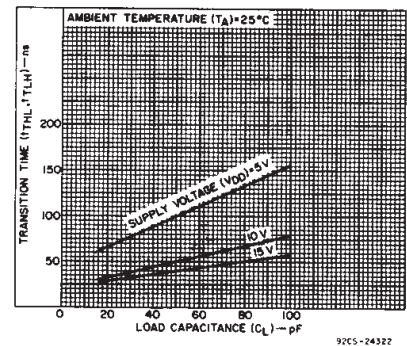

Fig. 9—Typical transition time as a function of load capacitance.

3
COMMERCIAL CMOS
HIGH VOLTAGE ICs

CD4517B Types

DYNAMIC ELECTRICAL CHARACTERISTICS at $T_A = 25^\circ\text{C}$; Input $t_r, t_f = 20\text{ ns}$, $C_L = 50\text{ pF}$, $R_L = 200\text{ k}\Omega$

CHARACTERISTIC	TEST CONDITIONS	V _{DD} (V)	LIMITS			UNITS
			Min.	Typ.	Max.	
Propagation Delay Time: CL to Bit 16 Tap t _{PHL} , t _{PLH}		5	—	200	400	ns
		10	—	110	220	
		15	—	90	180	
3-State Output, WE to Bit 16 Tap t _{PZH} , t _{PLZ} ; t _{PZH} , t _{PZL} (See Note)		5	—	75	150	ns
		10	—	40	80	
		15	—	30	60	
Output Transition Time t _{THL} , t _{TLH}		5	—	100	200	ns
		10	—	50	100	
		15	—	40	80	
Write Enable-to-Clock Setup Time		5	0	-50	—	ns
		10	0	-25	—	
		15	0	-15	—	
Data-to-Clock Setup Time, t _s		5	20	0	—	ns
		10	10	0	—	
		15	10	0	—	
Minimum Write Enable-to-Clock Release Time		5	—	50	100	ns
		10	—	25	50	
		15	—	20	40	
Minimum Data-to-Clock Hold Time, t _H		5	—	100	200	ns
		10	—	50	100	
		15	—	25	50	
Minimum Clock Pulse Width, t _w		5	—	90	180	ns
		10	—	40	80	
		15	—	25	50	
Maximum Clock Input Frequency, f _{CL}		5	3	6	—	MHz
		10	6	12	—	
		15	8	15	—	
Maximum Clock Input Rise or Fall Time, t _{rCL} , t _{fCL}		5	UNLIMITED			μs
		10	UNLIMITED			
		15	UNLIMITED			
Input Capacitance C _{IN}	Any Input		—	5	7.5	pF

NOTE: Measured at the point of 10% change in output with an output load of 50 pF, R_L = 1 kΩ to V_{DD} for t_{PZL}, t_{PLZ} and R_L = 1 kΩ to V_{SS} for t_{PZH}, t_{PHZ}.

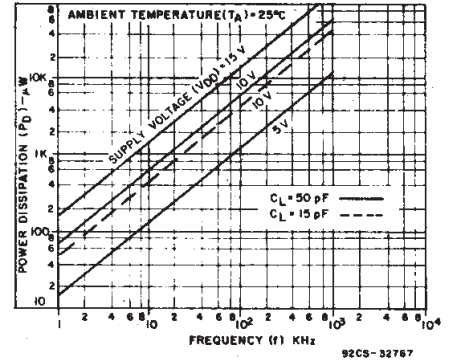

Fig. 10—Typical power dissipation as a function of frequency.

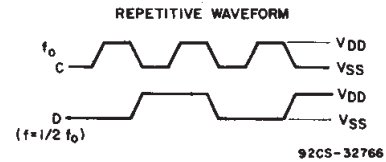
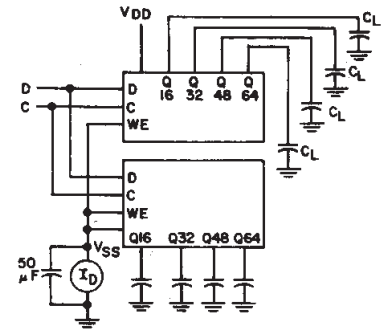

Fig. 11—Dynamic power dissipation test circuit and waveforms.

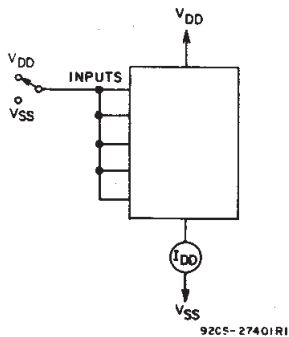

Fig. 12—Quiescent device current test circuit.

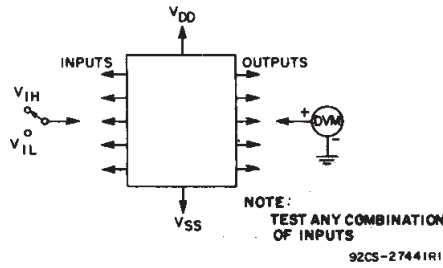

Fig. 13—Input voltage test circuit.

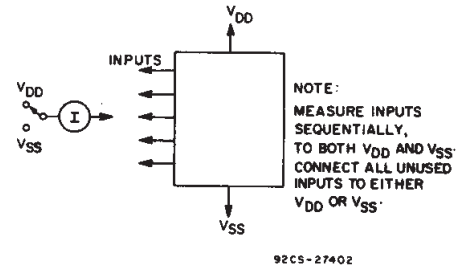
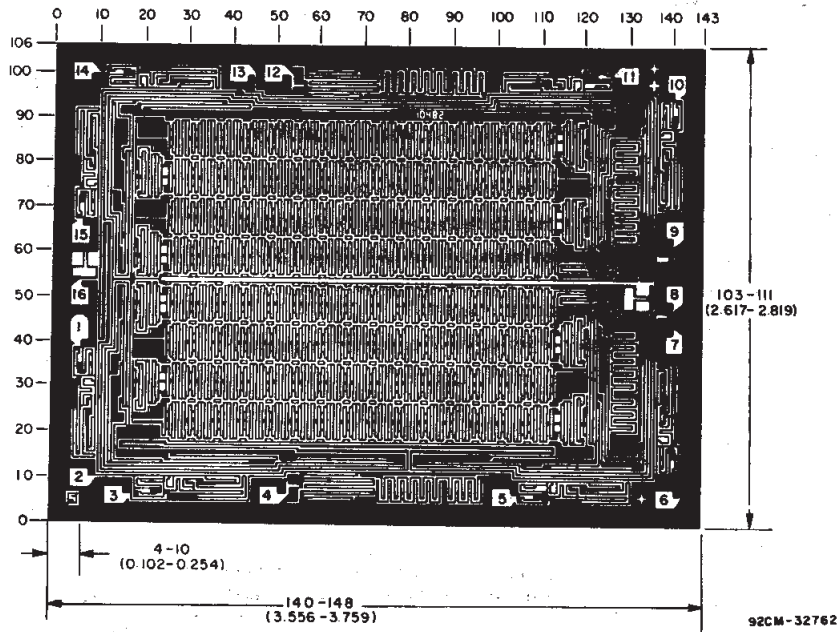

Fig. 14—Input current test circuit.

CD4517B Types



Dimensions and pad layout for CD4517B.

Dimensions in parentheses are in millimeters and are derived from the basic inch dimensions as indicated. Grid graduations are in mils (10^{-3} inch).

3
COMMERCIAL CMOS
HIGH VOLTAGE ICs

PACKAGING INFORMATION

Orderable Device	Status ⁽¹⁾	Package Type	Package Drawing	Pins	Package Qty	Eco Plan ⁽²⁾	Lead/Ball Finish	MSL Peak Temp ⁽³⁾
CD4517BE	ACTIVE	PDIP	N	16	25	Pb-Free (RoHS)	CU NIPDAU	Level-NC-NC-NC
CD4517BEE4	ACTIVE	PDIP	N	16	25	Pb-Free (RoHS)	CU NIPDAU	Level-NC-NC-NC
CD4517BF3A	ACTIVE	CDIP	J	16	1	TBD	Call TI	Level-NC-NC-NC

⁽¹⁾ The marketing status values are defined as follows:

ACTIVE: Product device recommended for new designs.

LIFEBUY: TI has announced that the device will be discontinued, and a lifetime-buy period is in effect.

NRND: Not recommended for new designs. Device is in production to support existing customers, but TI does not recommend using this part in a new design.

PREVIEW: Device has been announced but is not in production. Samples may or may not be available.

OBSOLETE: TI has discontinued the production of the device.

⁽²⁾ Eco Plan - The planned eco-friendly classification: Pb-Free (RoHS) or Green (RoHS & no Sb/Br) - please check <http://www.ti.com/productcontent> for the latest availability information and additional product content details.

TBD: The Pb-Free/Green conversion plan has not been defined.

Pb-Free (RoHS): TI's terms "Lead-Free" or "Pb-Free" mean semiconductor products that are compatible with the current RoHS requirements for all 6 substances, including the requirement that lead not exceed 0.1% by weight in homogeneous materials. Where designed to be soldered at high temperatures, TI Pb-Free products are suitable for use in specified lead-free processes.

Green (RoHS & no Sb/Br): TI defines "Green" to mean Pb-Free (RoHS compatible), and free of Bromine (Br) and Antimony (Sb) based flame retardants (Br or Sb do not exceed 0.1% by weight in homogeneous material)

⁽³⁾ MSL, Peak Temp. -- The Moisture Sensitivity Level rating according to the JEDEC industry standard classifications, and peak solder temperature.

Important Information and Disclaimer:The information provided on this page represents TI's knowledge and belief as of the date that it is provided. TI bases its knowledge and belief on information provided by third parties, and makes no representation or warranty as to the accuracy of such information. Efforts are underway to better integrate information from third parties. TI has taken and continues to take reasonable steps to provide representative and accurate information but may not have conducted destructive testing or chemical analysis on incoming materials and chemicals. TI and TI suppliers consider certain information to be proprietary, and thus CAS numbers and other limited information may not be available for release.

In no event shall TI's liability arising out of such information exceed the total purchase price of the TI part(s) at issue in this document sold by TI to Customer on an annual basis.

J (R-GDIP-T**)

14 LEADS SHOWN

CERAMIC DUAL IN-LINE PACKAGE



DIM \ PINS **	14	16	18	20
A	0.300 (7,62) BSC	0.300 (7,62) BSC	0.300 (7,62) BSC	0.300 (7,62) BSC
B MAX	0.785 (19,94)	.840 (21,34)	0.960 (24,38)	1.060 (26,92)
B MIN	—	—	—	—
C MAX	0.300 (7,62)	0.300 (7,62)	0.310 (7,87)	0.300 (7,62)
C MIN	0.245 (6,22)	0.245 (6,22)	0.220 (5,59)	0.245 (6,22)



4040083/F 03/03

- NOTES:
- All linear dimensions are in inches (millimeters).
 - This drawing is subject to change without notice.
 - This package is hermetically sealed with a ceramic lid using glass frit.
 - Index point is provided on cap for terminal identification only on press ceramic glass frit seal only.
 - Falls within MIL STD 1835 GDIP1-T14, GDIP1-T16, GDIP1-T18 and GDIP1-T20.

N (R-PDIP-T**)

PLASTIC DUAL-IN-LINE PACKAGE

16 PINS SHOWN



- NOTES:
- A. All linear dimensions are in inches (millimeters).
 - B. This drawing is subject to change without notice.
 - $\triangle C$ Falls within JEDEC MS-001, except 18 and 20 pin minimum body length (Dim A).
 - $\triangle D$ The 20 pin end lead shoulder width is a vendor option, either half or full width.

4040049/E 12/2002

IMPORTANT NOTICE

Texas Instruments Incorporated and its subsidiaries (TI) reserve the right to make corrections, modifications, enhancements, improvements, and other changes to its products and services at any time and to discontinue any product or service without notice. Customers should obtain the latest relevant information before placing orders and should verify that such information is current and complete. All products are sold subject to TI's terms and conditions of sale supplied at the time of order acknowledgment.

TI warrants performance of its hardware products to the specifications applicable at the time of sale in accordance with TI's standard warranty. Testing and other quality control techniques are used to the extent TI deems necessary to support this warranty. Except where mandated by government requirements, testing of all parameters of each product is not necessarily performed.

TI assumes no liability for applications assistance or customer product design. Customers are responsible for their products and applications using TI components. To minimize the risks associated with customer products and applications, customers should provide adequate design and operating safeguards.

TI does not warrant or represent that any license, either express or implied, is granted under any TI patent right, copyright, mask work right, or other TI intellectual property right relating to any combination, machine, or process in which TI products or services are used. Information published by TI regarding third-party products or services does not constitute a license from TI to use such products or services or a warranty or endorsement thereof. Use of such information may require a license from a third party under the patents or other intellectual property of the third party, or a license from TI under the patents or other intellectual property of TI.

Reproduction of information in TI data books or data sheets is permissible only if reproduction is without alteration and is accompanied by all associated warranties, conditions, limitations, and notices. Reproduction of this information with alteration is an unfair and deceptive business practice. TI is not responsible or liable for such altered documentation.

Resale of TI products or services with statements different from or beyond the parameters stated by TI for that product or service voids all express and any implied warranties for the associated TI product or service and is an unfair and deceptive business practice. TI is not responsible or liable for any such statements.

Following are URLs where you can obtain information on other Texas Instruments products and application solutions:

Products		Applications	
Amplifiers	amplifier.ti.com	Audio	www.ti.com/audio
Data Converters	dataconverter.ti.com	Automotive	www.ti.com/automotive
DSP	dsp.ti.com	Broadband	www.ti.com/broadband
Interface	interface.ti.com	Digital Control	www.ti.com/digitalcontrol
Logic	logic.ti.com	Military	www.ti.com/military
Power Mgmt	power.ti.com	Optical Networking	www.ti.com/opticalnetwork
Microcontrollers	microcontroller.ti.com	Security	www.ti.com/security
		Telephony	www.ti.com/telephony
		Video & Imaging	www.ti.com/video
		Wireless	www.ti.com/wireless

Mailing Address: Texas Instruments
Post Office Box 655303 Dallas, Texas 75265