

Thick Film Array Chip Resistor—CN Series

Construction

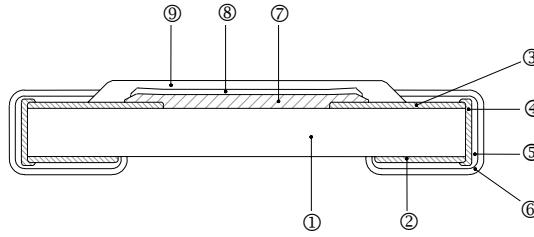

① Alumina Substrate	④ Edge Electrode (Ag)	⑦ Resistor Layer (RuO ₂ /Ag)
② Bottom Electrode (Ag)	⑤ Barrier Layer (Ni)	⑧ Primary Overcoat (Glass)
③ Top Electrode (Ag-Pd)	⑥ External Electrode (Sn)	⑨ Secondary Overcoat (Epoxy)

Features

- Small size and light weight
- Reduction of assembly costs and matching with placement machines
- Reliability, high quality
- Suitable for both IR reflow soldering and wave soldering

Applications

- Entertainment
- Computer & Related Products
- Communication Equipment
- Power Equipment
- Measuring Instrument

Part Numbering

CN-	42	F	L	6	----1K
Product Type	Dimensions	Resistance Tolerance	Function Code	Packaging Code	Resistance
CN- (Convex) CNA (Concave)	42: 0402x4 43: 0603x4	F: ±1% J: ±5%	L: 4P2R/8P4R	6: 7" Reel 10Kpcs 7: 7" Reel 5Kpcs A: 10" Reel 10Kpcs B: 10" Reel 20Kpcs C: 13" Reel 40Kpcs D: 13" Reel 20Kpcs F: Bulk	----1K: 1KΩ ---3K3: 3.3KΩ ---10K: 10KΩ *-* to fill up 6 spaces

Dimensions

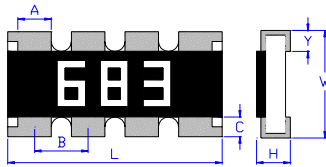

CN-42/CN-43

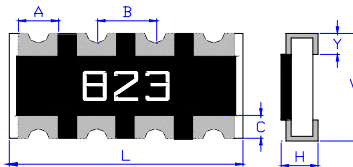

CNA42/43

Unit: mm

Type	Number of Resistors	L	W	H	A	B	C	Y	Weight (g) (1000pcs)
CN-42	4	2.00±0.10	1.00±0.10	0.45±0.10	0.30±0.10	0.50±0.05	0.22±0.15	0.22±0.15	2.817
CN-43	4	3.20±0.15	1.60±0.15	0.55±0.10	0.50±0.15	0.80±0.05	0.30±0.15	0.30±0.15	8.288
CNA42	4	2.00±0.10	1.00±0.10	0.40±0.10	0.30±0.10	0.50±0.05	0.20±0.10	0.25±0.10	3.003
CNA43	4	3.20±0.15	1.60±0.15	0.55±0.10	0.50±0.15	0.80±0.05	0.30±0.15	0.40±0.15	10.115

Derating Curve

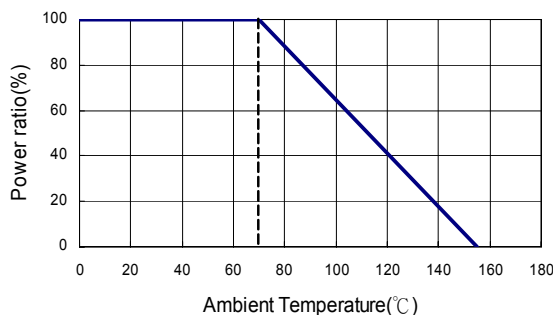

Standard Electrical Specifications

Type	Item	Power Rating / Rated Current	Operating Temp. Range	Max. Operating Voltage	Max. Overload Voltage	Number of Resistors	Resistance Range		TCR (PPM/°C)
							±1%	±5%	
CN-42	1/16W	1A	-55 ~ +155°C	25V	50V	4	10Ω - 1MΩ	1Ω - 1MΩ	±200
Jumper	0Ω (<50mΩ)								
CN-43	1/10W	1A	-55 ~ +155°C	50V	100V	4	10Ω - 1MΩ	1Ω - 1MΩ	±200
Jumper	0Ω (<50mΩ)								
CNA42	1/16W	1A	-55 ~ +155°C	25V	50V	4	10Ω - 1MΩ		±200
Jumper	0Ω (<50mΩ)								
CNA43	1/16W	1A	-55 ~ +155°C	50V	100V	4	10Ω - 1MΩ		±200
Jumper	0Ω (<50mΩ)								

Operating Voltage= $\sqrt{P \cdot R}$ or Max. operating voltage Listed above, whichever is lower.

Overload Voltage= $2.5 \cdot \sqrt{P \cdot R}$ or Max. overload voltage Listed above, whichever is lower.

■ Viking is capable of manufacturing the optional spec based on customer's requirement.

Environmental Characteristics

Item	Requirement			Test Method
	±1%	±5%	Jumper	
Temperature Coefficient of Resistance (T.C.R.)	As Spec.			-55°C~+125°C, 25°C is the reference temperature
Short Time Overload	$\pm(1.0\%+0.05\Omega)$	$\pm(2.0\%+0.05\Omega)$	<50mΩ	RCWV*2.5 or Max. overload voltage for 5 seconds
Insulation Resistance	≥10G			Max. overload voltage for 1 minute
Endurance	$\pm(2.0\%+0.10\Omega)$	$\pm(3.0\%+0.10\Omega)$	<50mΩ	70±2°C, Max. working voltage for 1000 hrs with 1.5 hrs "ON" and 0.5 hrs "OFF"
Damp Heat with Load	$\pm(2.0\%+0.10\Omega)$	$\pm(3.0\%+0.10\Omega)$	<50mΩ	40±2°C, 90~95% R.H. Max. working voltage for 1000 hrs with 1.5 hrs "ON" and 0.5 hrs "OFF"
Dry Heat	$\pm(1.0\%+0.05\Omega)$	$\pm(1.5\%+0.10\Omega)$	<50mΩ	at +155°C for 1000 hrs
Bending Strength	$\pm(1.0\%+0.05\Omega)$	$\pm(1.0\%+0.05\Omega)$	<50mΩ	Bending once for 5 seconds with 3mm
Solderability	95% min. coverage			245±5°C for 3 seconds
Resistance to Soldering Heat	$\pm(0.5\%+0.05\Omega)$	$\pm(1.0\%+0.05\Omega)$	<50mΩ	260±5°C for 10 seconds
Voltage Proof	No breakdown or flashover			1.42 times RCWV (RMS) for 1 minute
Leaching	Individual leaching area ≤5% Total leaching area ≤ 10%			260±5°C for 30 seconds
Rapid Change of Temperature	$\pm(0.5\%+0.05\Omega)$	$\pm(1.0\%+0.05\Omega)$	<50mΩ	-55°C to +155°C, 5 cycles

■ Reference Standards: IEC 60115-1, 60068-2-58; JIS-C 5201-1

■ Storage Temperature: 25±3°C; Humidity < 80%RH

■ Packaging

Reel Specifications & Packaging Quantity

Unit: mm

Type	Packaging Quantity	Tape Width	Reel Diameter	ΦA	ΦB	ΦC	W	T
CN-42 CNA42	Paper 10K 20K 40K	8mm	7 inch	178.5±1.5	60 ^{+1/-0}	13.0±0.2	9.0±0.5	12.5±0.5
			10 inch	254±1.0	100±0.5	13.0±0.2	9.5±0.5	13.5±0.5
			13 inch	330±1.0	100±0.5	13.0±0.2	9.5±0.5	13.5±0.5
CN-43 CNA43	Paper 5K 10K 20K	8mm	7 inch	178.5±1.5	60 ^{+1/-0}	13.0±0.2	9.0±0.5	12.5±0.5
			10 inch	254±1.0	100±0.5	13.0±0.2	9.5±0.5	13.5±0.5
			13 inch	330±1.0	100±0.5	13.0±0.2	9.5±0.5	13.5±0.5

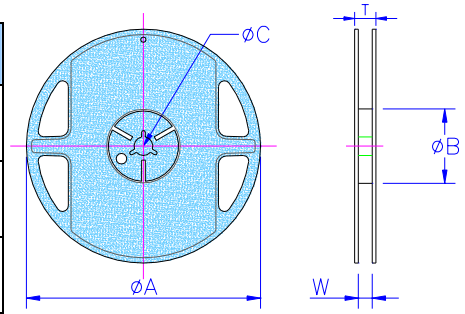

Paper Tape Specifications

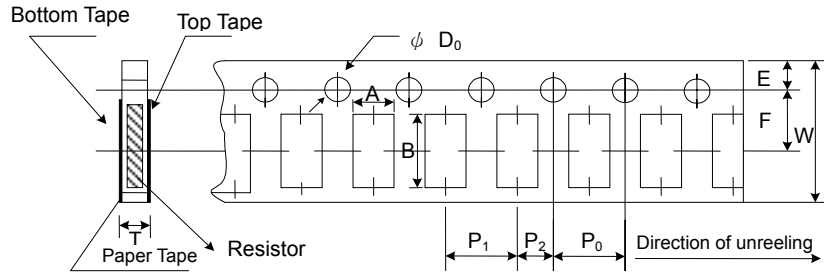

Unit: mm

Type	A	B	W	E	F	P ₀	P ₁	P ₂	ΦD_0	T
CN-42	1.20±0.10	2.20±0.10	8.0±0.20	1.75±0.10	3.5±0.05	4.0±0.10	2.0±0.05	2.0±0.05	1.5 ^{+0.1/-0}	0.70±0.10
CN-43	1.95±0.10	3.50±0.10	8.0±0.20	1.75±0.10	3.5±0.05	4.0±0.10	4.0±0.05	2.0±0.05	1.5 ^{+0.1/-0}	0.85±0.10
CNA42	1.20±0.10	2.20±0.10	8.0±0.20	1.75±0.10	3.5±0.05	4.0±0.10	2.0±0.05	2.0±0.05	1.5 ^{+0.1/-0}	0.70±0.10
CNA43	1.95±0.10	3.50±0.10	8.0±0.20	1.75±0.10	3.5±0.05	4.0±0.10	4.0±0.05	2.0±0.05	1.5 ^{+0.1/-0}	0.85±0.10

■ Equivalent Circuit Diagram

CN-42 / 43

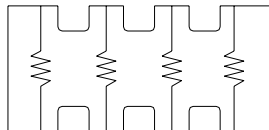

CNA42 / 43

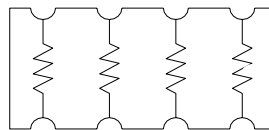

■ Recommend Land Pattern

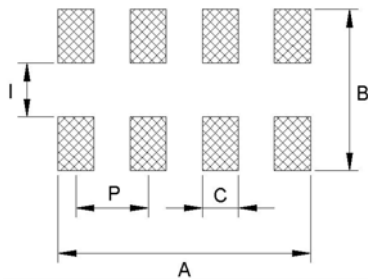

Unit: mm

Type	A	B	C	C1	I	I1	P	P1
CN-42	1.80	2.10	0.30	--	0.50	--	0.50	--
CN-43	2.85	3.10	0.45	--	0.80	--	0.80	--
CNA42	1.80	2.10	0.30	--	0.50	--	0.50	--
CNA43	2.85	3.10	0.45	--	0.80	--	0.80	--