

03 SV

Circular connectors with threaded joint M16 acc. to IEC 61076-2-106, IP40/IP67/IP68

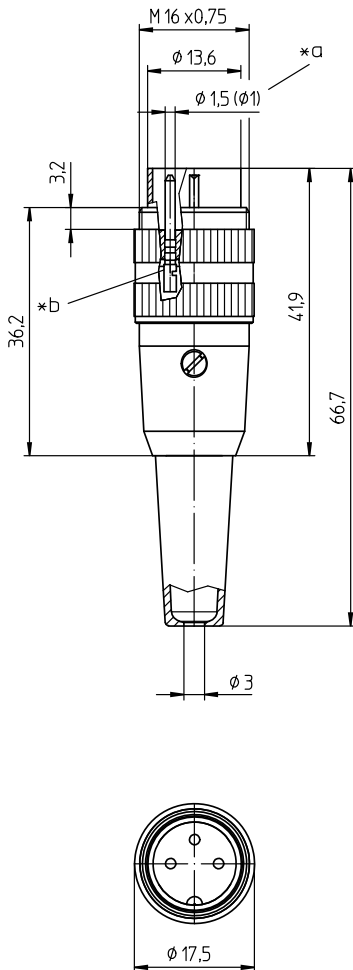

Plug acc. to IEC 61076-2-106, IP40, straight version, with threaded joint, solder terminals and long bend protection



Environmental conditions

Temperature range -40 °C/+85 °C

Materials

Insulating body	PA GF, V-0 according to UL94
Contact pin	CuZn, silver-plated and flash gold-plated (3-8 poles) CuZn, pre-nickel and gold-plated (12 poles)
Ground contact spring	CuZn, pre-nickel and tin-plated
Sleeve	PC, HB according to UL94
Strain relief	steel, nickel-plated
Housing	CuZn, nickel-plated
Knurled screw	CuZn, nickel-plated
Bend protection sleeve	TPE
Screw	steel, nickel-plated

Mechanical data

Tightening torque connector	1-3 Nm
Tightening torque nut	1-3 Nm
Protection class	IP40 ¹

¹ according to IEC DIN EN 60529, only in locked condition with an appropriate counterpart

Connectable conductors for solder area

Section	≤ 0,75 mm ² (AWG 20) (3-8 poles) ≤ 0,25 mm ² (AWG 24) (12 poles)
Cable diameter	4-6 mm

Electrical data (at T_{amb} 20 °C)

Rated current	5 A (T _{amb} 40 °C, 3-8 poles) 3 A (T _{amb} 40 °C, 12 poles)
Rated voltage	with pollution degree 1: 300 V (versions 30, 40, 50/6, 60, 70) 100 V (versions 50, 71, 80, 81) 160 V (Polbild 120) with pollution degree 2: 250 V (versions 30, 40) 32 V (versions 50, 71, 80, 81) 160 V (versions 50/6, 60, 70, 120)
Rated impulse voltage	1500 V (versions 30, 40, 50/6, 60, 70, 120) 500 V (versions 50, 71, 80, 81)
Material group	II (IEC)/I (UL) (400 = CTI < 600)
Overvoltage category	I
Insulation resistance	> 100 MΩ

03 SV

Pin configurations, solder side view

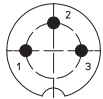

03-a
SV 30

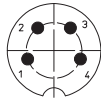

04-a
SV 40

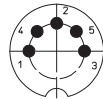

05-b
SV 50

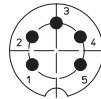

05-a
SV 50/6

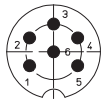

06-a
SV 60

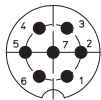

07-a
SV 70

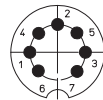

07-b
SV 71

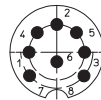

SV 80

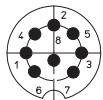

08-a
SV 81

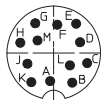

12-a
SV 120

Associated products

Counterparts

☑ 030398

☑ KGR

☑ KV ...-8

☑ KFR

☑ KGV

☑ WKV

☑ KfV

☑ KV

Accessories

☑ 0383

☑ 038399

☑ 038899

*a 12 pole version Ø 1.0 mm

*b cup-shaped solder terminal

03 SV

Designation	Pole Number	PU (Pieces)	MDQ (Pieces)
SV 30	3	50	100
SV 40	4	50	100
SV 50	5	50	100
SV 50/6	5	50	100
SV 60	6	50	100
SV 70	7	50	100
SV 71	7	50	100
SV 80	8	50	100
SV 81	8	50	100
SV 120	12	50	100
SV 50 unmontiert	5	50	100
SV 50/6 unmontiert	5	50	100
SV 60 unmontiert	6	50	100
SV 70 unmontiert	7	50	100

Packaging:

preassembled, in a cardboard box (SV)

sorted individual parts in a cardboard box (SV unmontiert)