

N CHANNEL LATERAL MOSFET

N Channel Lateral Mosfet

- Designed specifically for linear audio amplifier applications
- High-speed for high bandwidth amplifiers
- High voltage rating - 200V
- TO-264 plastic package
- Enhanced oscillation suppression in multi-device applications
- Complementary P-channel available – ECW20P20

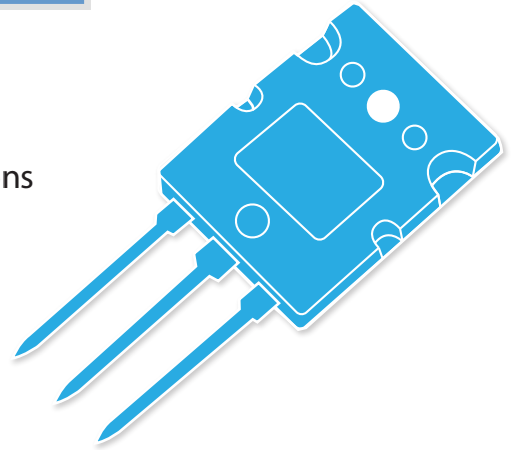

ABSOLUTE MAXIMUM RATINGS

($T_C = 25^\circ\text{C}$ unless otherwise stated)

V_{DSS}	Drain – Source Voltage	200V
V_{GSS}	Gate – Source Voltage	+/-14V
I_D	Continuous Drain Current	16A
I_{DR}	Body Drain Diode Current	16A
P_D	Allowable Power Dissipation* $T_{case} = 25^\circ\text{C}$	250W
T_{ch}	Channel Temperature	150°C
T_{stg}	Storage Temperature Range	-55 to +150°C

*Thermal Resistance, Junction To Case

0.5 deg/watt

ELECTRICAL CHARACTERISTICS (TC = 25°C unless otherwise stated)

Symbols	Parameters	Test Conditions		Min.	Typ	Max.	Units
BV_{DSX}	Drain-Source Breakdown Voltage	$V_{GS} = -10V$	$I_D = 10mA$	200			V
I_{GSS}	Gate-Source Leakage Current	$V_{DS} = 0$	$V_{GS} = \pm 20V$			100	μA
$V_{GS(off)}$	Gate-Source Cut-off Voltage	$V_{DS} = 10V$	$I_D = 100mA$	0.1		1.5	V
$V_{DS(sat)}^*$	Drain-Source Saturation Voltage	$V_{GD} = 0$	$I_D = 16A$			12	V
$ y_{fs} ^*$	Forward Transfer Admittance	$V_{DS} = 10V$	$I_{DS} = 3A$	1.4		4	S(\bar{O})
I_{DSX}	Drain-Source Cut-Off Current	$V_{GS} = -10V$	$V_{DS} = 200V$			10	mA

* Pulse Test: Pulse Width = 300 μ s, Duty Cycle \leq 2%

DYNAMIC CHARACTERISTICS

Symbols	Parameters	Test Conditions	Min.	Typ	Max.	Units
C_{iss}	Input Capacitance			900		pF
C_{oss}	Output Capacitance	$V_{GS} = 0$		500		pF
C_{rss}	Reverse Transfer Capacitance	$V_{DS} = 10V$ $f = 1.0MHz$		16		pF
t_{on}	Turn-On Time	$V_{DS} = 20V$		155		ns
t_{off}	Turn-Off Time	$I_D = 7A$		90		ns

Exicon products are available at www.profusionplc.com

GENERAL CHARACTERISTICS (T = 25°C unless otherwise stated)

Typical Output Characteristics

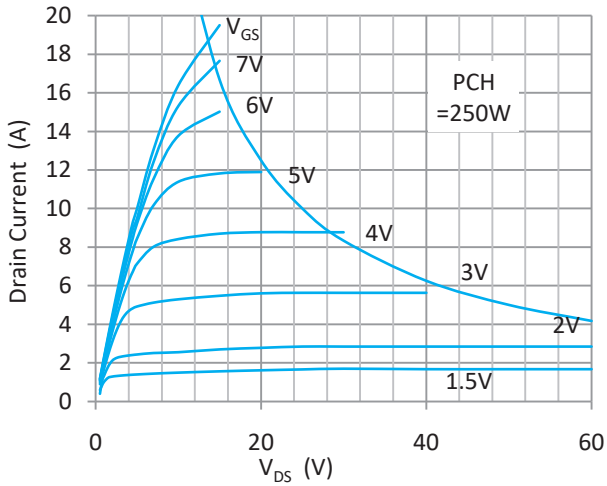

Typical Output Characteristics

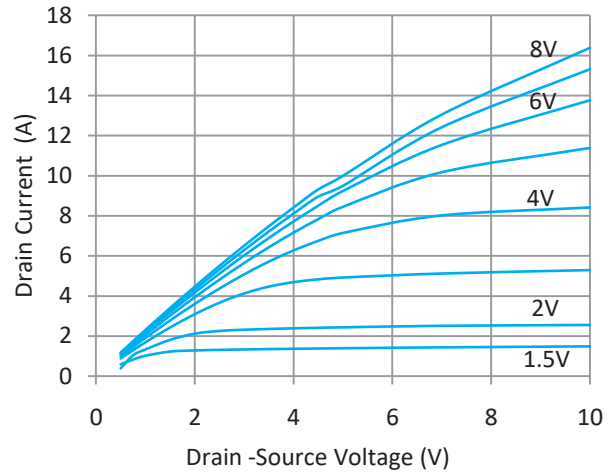

Transfer Characteristics

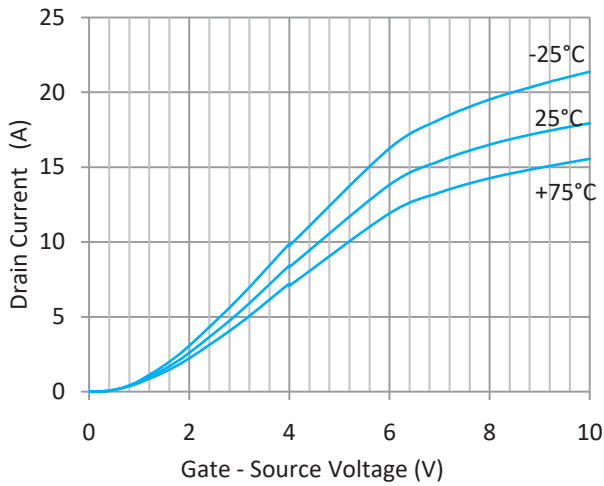

Typical Transfer Characteristic

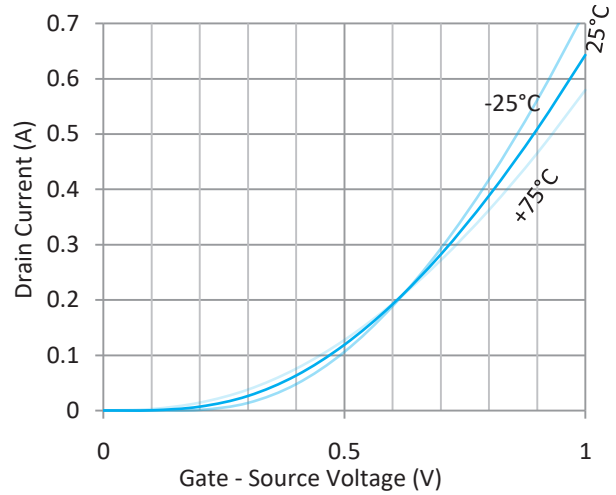

Drain-Source vs Gate-Source Voltage

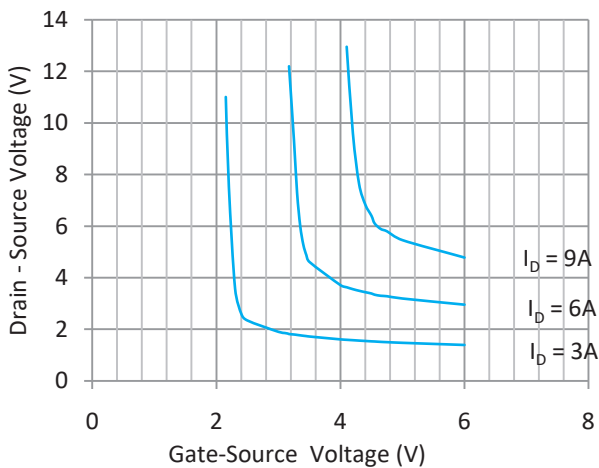

Transconductance

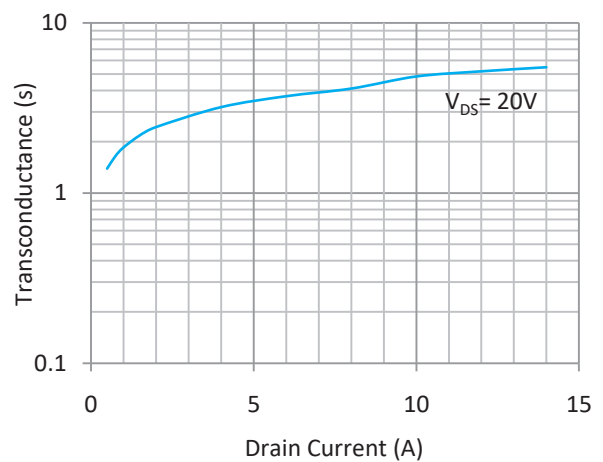

Typical Capacitance vs Gate -Source Voltage (-V)

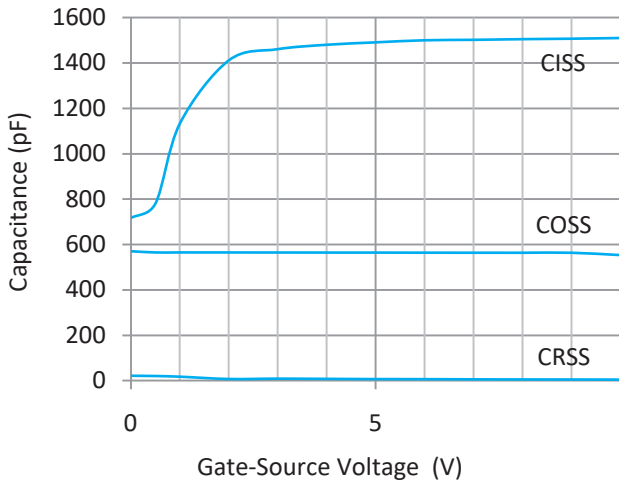

Forward Bias Safe Operating Area

