



承 認 書

SPECIFICATION FOR APPROVAL

客 戶 : CUSTOMER	LOMEX	承認圖號 : APP. NO.	D140052013
系 列 : SERIES	FX	使用溫度範圍 : OPERATION TEMP. RANGE	-40~+105°C

本公司料號 VENDOR'S PART NO.	貴公司料號 BUYER'S PART NO.
EFX***M*****0	

貴公司承認印 BUYER'S APPROVAL STAMP	智寶電子(東莞)有限公司 TEAPO ELECTRONICS(Dong Guan) CORPORATION	
		
	APPROVED BY:	TESTED BY:
		

智寶電子股份有限公司
台北縣新店市寶橋路 235 巷 1 弄 2 號

Teapo Electronics Corporation
3F,No.2,Alley 1.Lane 235,Baoqiao Rd., Xindian City, Taipei
County 231,Taiwan
Tel :+886-2-66298899 (Rep) Fax :+886-2-66296699

智寶電子(東莞)有限公司
廣東省東莞市塘廈鎮高麗工業區高麗一路
6A2、6A3 號

Teapo Electronic (Dongguan) Co.,Ltd.
Address: 6A3.6A2,Gaoli 1st Rd. Gaoli Ind. Zone, Tangxia Town,
Dongguan City, Guangdong 523726, China.
Tel : +86-769-8791-4676 Fax : +86-769-8791-4770

智寶電子(蘇州)有限公司
蘇州市高新區長江路 179 號 2 號門三樓

Teapo Electronic (Suzhou) Co., Ltd
3F,No.2,No.179,South Changjiang Rd.,High New District,Suzhou
City,Jiang Su,China.
Tel : +86-512-6636-6868 Fax :+86-512-6636-5556

I . Scope

This standard defines characteristics and dimensions for aluminum electrolytic capacitors named FX Series is low profile/ultra-miniature and 5mm height product

II . Diagram of Dimensions

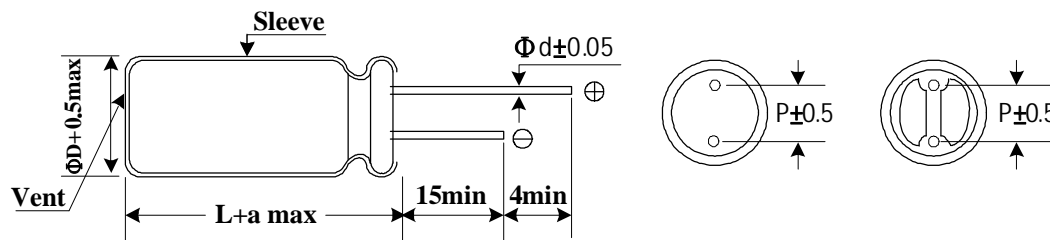

*Safety vent only for :Dimension $\geq 6.3 \times 11$

Diameter(φD)	4	5	6.3	8
Lead space(P)	1.5	2.0	2.5	3.5
Lead diameter(φd)	0.45	0.45	0.45	0.45
a	1.0	1.0	1.0	1.0

III . Characteristics

Standard test condition

Unless otherwise specified all tests shall be performed at, or referred to, an ambient temperature of 20°C and a relative humidity not greater than 60%.

Operating Temperature Range

4~50VDC -40~+105°C

1. Electrical characteristics

(1). Rated Voltage and Surge Voltage

WV: Working Voltage (VDC)

SV: Surge Voltage (V)

WV	4	6.3	10	16	25	35	50
SV	5	8	13	20	32	44	63

(2). Leakage Current

The maximum leakage current is specified in the following formula after DC working voltage applied .

4~50WV $I=0.01CV$ or $3 (\mu A)$ for 2 minutes whichever is greater

where I: Leakage Current (μA)

C: Nominal Capacitance (μF)

V: Rated Voltage (V)

Measurement circuit

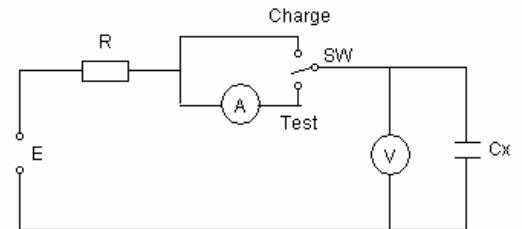

(3). Capacitance Tolerance

Capacitance tolerance should be within the range of $\pm 20\%$ which is measured at 120Hz/20°C.

(4). Dissipation Factor

Dissipation Factor at 120Hz/ 20°C shall not exceed the values given in the table below.

WV	4	6.3	10	16	25	35	50
DF(%)	35	24	20	17	15	12	10

Note: Above DF specifications shall be 2% added for every 1000uF capacitor exceeding 1000uF.

(5). Low Temperature Characteristics

The ratio of impedance at -25°C/+20°C and -40°C/+20°C of the capacitor shall be less than the following value at 120Hz.

WV	4	6.3	10	16	25	35	50
Z(120Hz)							
Z(-25°C) / Z(+20°C)	6	4	3	2	2	2	2
Z(-40°C) / Z(+20°C)	12	8	6	4	4	3	3

(6). Multiplier for Ripple Current

Frequency coefficient

Frequency (Hz)	120	300	1K	10K
0.1~47 μF	1.00	1.20	1.30	1.50
100~330 μF	1.00	1.10	1.15	1.20

2. Mechanical Characteristics

Lead Pull Test

Capacitors shall be with stand the pull test shown in the following table.

Lead diameter (mm)	Load (Kg)	Test time (sec)
$d \leq 0.5$	0.5	30 ⁺⁵ -0
$0.5 < d \leq 0.8$	1.0	30 ⁺⁵ -0
$0.8 < d \leq 1.2$	2.5	30 ⁺⁵ -0

3. Endurance characteristics**(1).Load Life**

To put capacitors in to the oven which is staying at $105\pm 2^{\circ}\text{C}$, then to add rated voltage in the capacitors. This experiment will be lasted for $1000 +12 / -0$ hours. We will examine the electronic characters after getting them cooled down to room temperature. The values must not be over those on following table.

Capacitance Change	Within $\pm 20\%$ of initial value
Dissipation Factor	200% or less of initial specified value
Leakage Current	initial specified value or less

(2). Shelf Life

The following specifications shall be satisfied when the capacitors are restored to 20°C after exposing them at $105\pm 2^{\circ}\text{C}$ for $500+12/-0$ hours without voltage applied.

Capacitance Change	Within $\pm 20\%$ of initial value
Dissipation Factor	200% or less of initial specified value
Leakage Current	200% or less of initial specified value

(3). Solderability Test

The following specifications shall be satisfied when the lead wires are tested in solder bath at $245\pm 5^{\circ}\text{C}$ for 2.5 ± 0.5 seconds, more than 95% of the terminal surface shall be covered with new solder.

(4). Solder Heat Resistance Test

The following specifications shall be satisfied when the lead wires are tested in solder bath at $270+2/-0^{\circ}\text{C}$ for 20 ± 0.5 seconds.

Capacitance Change	$\leq \pm 5\%$ of the initial value
Dissipation factor	\leq Initial specified value
Leakage Current	\leq Initial specified value

IV. Mounting

The paper separators and the electrolytic-conductive electrolytes in a non-solid aluminum electrolytic capacitor is flammable.

Leaking electrolyte on a PC board can gradually erode the copper traces, possibly causing smoke or burning by short-circuiting the copper traces.

Verify the following points when designing a PC board.

- (1) Provide the appropriate hole spacing on the PC board to match the terminal spacing of the capacitor.
- (2) Make the following open space over the vent so that the vent can operate correctly.

<u>Case diameter</u>	<u>Clearance</u>
ϕ 6.3 to ϕ 13 mm	2 mm minimum
ϕ 16 to ϕ 35 mm	3 mm minimum
ϕ 40 mm and up	5 mm minimum

- (3) Do not place any wires or copper traces over the vent of the capacitor.
- (4) Installing a capacitor with the vent facing the PC board needs an appropriate ventilation hole in PC board.
- (5) Do not pass any copper traces beneath the seal side of a capacitor.
The trace must pass 1 or 2 mm to the side of the capacitor.
- (6) Avoid placing any heat-generating objects adjacent to a capacitor or even on the reverse side of the PC board.
- (7) Do not pass any via holes or underneath a capacitor.
- (8) In designing double-sided PC boards, do not locate any copper trace under the seal side of a capacitor.

V. Storage Condition

- (1) Aluminum Electrolytic Capacitors should not be stored in high temperatures or where there is a high level of humidity. The suitable storage condition is 5~35°C and less than 75% in relative humidity.
- (2) Aluminum Electrolytic Capacitors should not be stored in damp conditions such as water, saltwater spray or oil spray.
- (3) Do not store Aluminum Electrolytic Capacitors in an environment full of hazardous gas (hydrogen sulfide, sulfurous acid gas, nitrous acid, chlorine gas, ammonium, etc...).
- (4) Aluminum Electrolytic Capacitors should not be stored under exposure to ozone, ultraviolet rays or radiation.
- (5) If a capacitor has been stored for more than one year under normal temperature (shorter if high temperature) and it shows increased leakage current, then a treatment by voltage application is recommended. The capacitor which hasn't been treated mustn't be used directly.

VI. Marking

Marking on capacitor include:

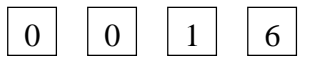
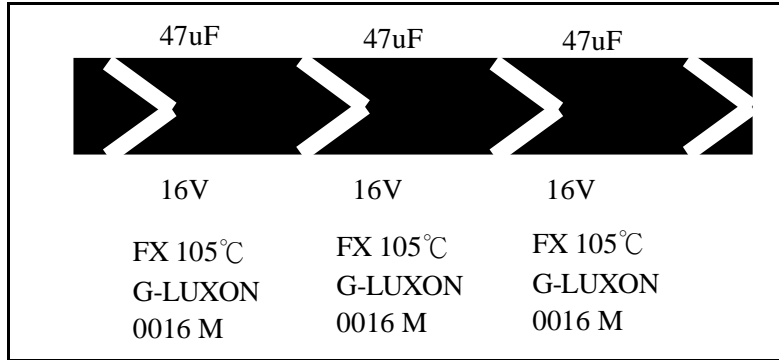

Supplier and material & Origin
Month: Jan
Year: 2010

- ⌞ G-LUXON trademark
- ⌞ Nominal capacitance
- ⌞ Working voltage
- ⌞ Polarity
- ⌞ Series No.
- ⌞ Max operating temperature
- ⌞ Date code
- ⌞ Capacitance tolerance

Remark: Date code numbering system. Date code is indicated manufactured date

Manufactured year

Code	0	1	2	3	4	5	6
Year	2010	2011	2012	2013	2014	2015	2016

Manufactured month

Month	1	2	3	4	5	6	7	8	9	10	11	12
Code	01	02	03	04	05	06	07	08	09	10	11	12

Sleeve Suppiler(Made in Dongguan)

Supplier	CHI YUAN	YUN LIN	CHI YUAN	YUN LIN
Code	4	6	5	7
material	PVC	PVC	PET	PET

The above code descriptions are just examples, they haven't completely shown all sleeve suppliers.

VII. Catalog numbering

G-LUXON FX TYPE (Part Number)

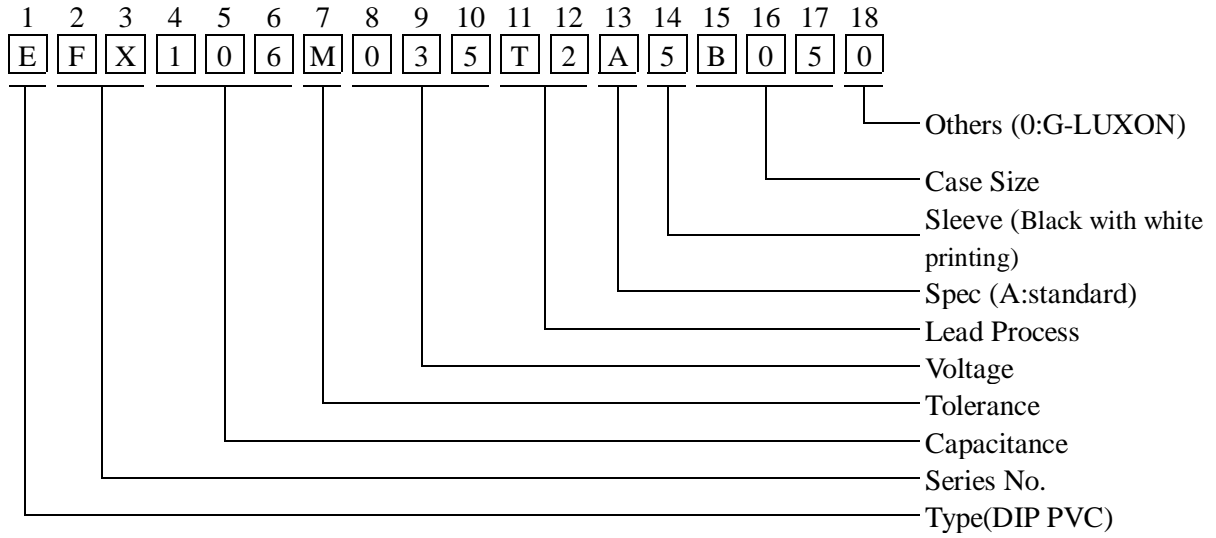

VIII. PACKAGING SPECIFICATION

Miniature Aluminum Electrolytic Capacitors

For Bulk: Standard Cutting & Forming

Classification	Standard Bulk				Cutting & Forming				Min. ordering amount
	Case size D*L(mm)	Vinyl bag	inner box 289*168*279 (mm)	outer carton 355*297*290 (mm)	gross weight (kg)	Vinyl bag	inner box 289*168*135 (mm)	outer carton 355*297*290 (mm)	
4×5	2,000	24,000	48,000	13	2,000	20,000	80,000	20	25
4×7	2,000	20,000	40,000	11	2,000	16,000	64,000	17	25
5×5	2,000	20,000	40,000	12	2,000	16,000	64,000	18	25
5×7	2,000	16,000	32,000	13	2,000	16,000	64,000	23	25
5×11	1,000	12,000	24,000	13	1,000	10,000	40,000	22	25
6.3×5	2,000	16,000	32,000	11	2,000	10,000	40,000	16	20
6.3×7	2,000	12,000	24,000	10	2,000	10,000	40,000	15	20
6.3×11	1,000	10,000	20,000	14	1,000	7,000	28,000	17	20
8×7	500	10,000	20,000	14	500	6,500	26,000	16	15
8×9,8×11	500	7,500	15,000	17	500	4,000	16,000	18	15
8×14,8X15	500	5,000	10,000	12	500	3,000	12,000	14	15
8×16	500	5,000	10,000	16	200	2,000	8,000	13	15
8×20	200	4,000	8,000	14	200	2,000	8,000	14	15
10×12.5	200	4,000	8,000	15	200	2,000	8,000	15	12
10×15	200	3,600	7,200	16	200	2,000	8,000	18	12
10×17	200	3,600	7,200	17	200	1,600	6,400	15	12
10×20	200	3,000	6,000	19	200	1,400	5,600	17	12
10×25	200	2,400	4,800	17	200	1,200	4,800	16	12
13×13,13×15	200	2,400	4,800	15	200	800	3,200	13	10
13×18,13×20	200	1,800	3,600	15	200	600	2,400	10	10
13×25	200	1,200	2,400	14	200	600	2,400	14	10
13×30	200	1,200	2,400	16	100	500	2,000	14	10
13×34,13×36	100	1,000	2,000	14	100	300	1,200	12	10
13×38,13×40	100	800	1,600	15	100	300	1,200	15	10

Classification	Standard Bulk				Cutting & Forming				Min. ordering amount
	Case size D*L(mm)	Vinyl bag	inner box (mm)	outer carton (mm)	gross weight (kg)	Vinyl bag	inner box (mm)	outer carton (mm)	
16X15、 16X20	200	1000	2000	22	200	1000	2000	22	5
16X25	200	1000	2000	24	-	500	4000	44	5
16X30、 16X32、	200	800	1600	20	-	500	3000	37	5
16X36、 16X40	200	600	1200	22	-	500	3000	55	5
16X45	100	500	1000	22	-	-	-	-	5
18X15、 18X20	200	800	1600	21	-	-	-	-	2.5
18X22、 18X25	200	800	1600	23	-	500	2000	28	2.5
18X30	100	600	1200	25	-	-	-	-	2.5
18X32、 18X36、 18X40	100	500	1000	25	-	500	1000	25	2.5
18X45、 18X50	100	300	600	21	-	600	1200	40	2.5
20X25	-	-	-	-	-	400	800	20	1.5
22X32	-	-	-	-	-	320	1920	55	1.5
22X30	-	-	-	-	-	400	800	25	1.5
22X35、 22X40	100	300	600	21	-	400	800	27	1.5

For Taping Ammo & Reel

Classification Case size D φ (mm)	Ammo Tape					Reel Tape			Min. ordering amount kpcs
	inner box (mm)	quantity (pcs)	outer carton (mm)	quantity (pcs)	gross weight (kg)	inner carton 350*350*110 (mm)	outer carton 370*370*600 (mm)	gross weight (kg)	
4 φ	340×275×50	3,000	355×297×290	15,000	6	3,000	15,000	8	25
5 φ	340×230×50	2,000	355×252×290	10,000	6 ~ 7	2,400	12,000	8	25
6.3 φ	340×275×50	2,000	355×297×290	10,000	8	2,000	10,000	6	20
8 φ ×5-16L	340×230×50	1,000	355×252×290	5,000	7	1,600	8,000	12	15
8 φ ×20L	340×230×58	1,000	355×252×315	5,000	7	1,000	5,000	12	15
10 φ ×10~17L	340×230×50	600	355×252×290	3,000	7				12
10 φ ×20~25L	340×230×58	600	355×252×315	3,000	7	-	-	-	12
10 φ ×30L	340×230×65	600	355×252×290	2,400	7	-	-	-	12
13 φ ×32L below	315×275×65	400	355×297×290	1,600	5	-	-	-	10
13 φ ×36L above	315×275×74	400	355×297×337	1,600	5	-	-	-	10
16 φ ×32L below	315×275×65	300	355×297×290	1,200	5	-	-	-	5
16 φ ×36L above	315×275×74	300	355×297×337	1,200	5	-	-	-	5

Note : For 10 φ Reel Tape :

size	inner carton(pcs)	outer carton(pcs)
10 φ ×10~16L	1,200	6,000
10 φ ×17~20L	1,000	5,000

IX. Others

- (1) All Teapo capacitors comply to RoHS(Restriction of Hazardous Substances) requirements where Chromium VI(Cr+6),Cadmium(Cd) , Mercury(Hg), Lead(pb), Polybrominated biphenyls(PBBs)and Polybrominated biphenyl/diphenyl ethers (PBBEs/PBDEs) have not been detected [lower than MDL (Method Detection Limit)] per SGS certification test report..
 - (2)Satisfied characteristic JIS C 5101
 - (3)Aluminum Electrolytic Capacitors may b e damaged by corrosion which is caused by any halogenated hydrocarbon solvents.
- Please let us know in advance the solvent name and conditions for your PCB cleaning

X. Lead processing type and Taping

Code S1: Standard Type

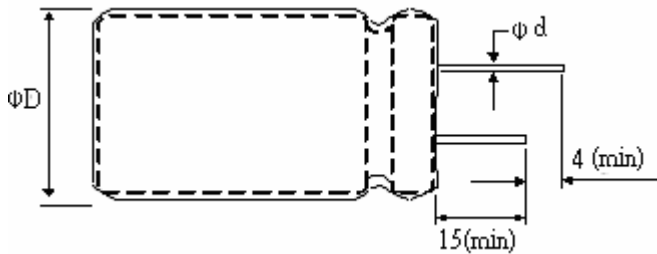

Code C3: Straight Cut

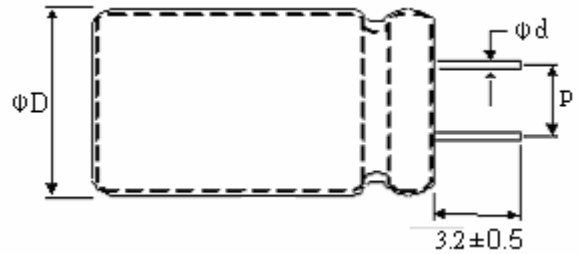

Code F6: Forming Cut ($\phi 4 \sim \phi 8$)

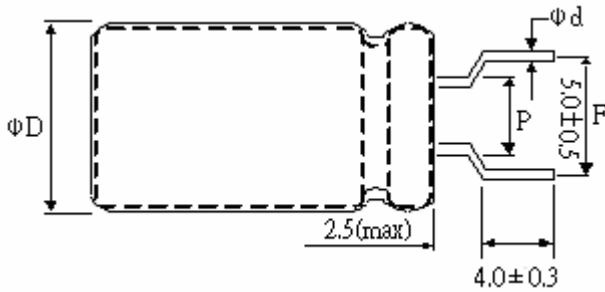

Code C5: Straight Cut

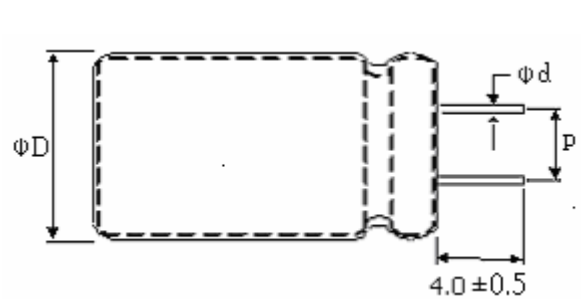

Code K2: Kink cut, & Crimping

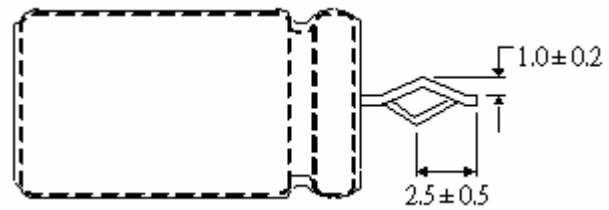
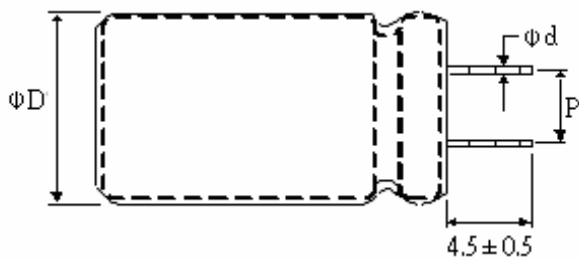

Code T1/R1: Ammo/Reel Tape(φ 4~φ 6.3)

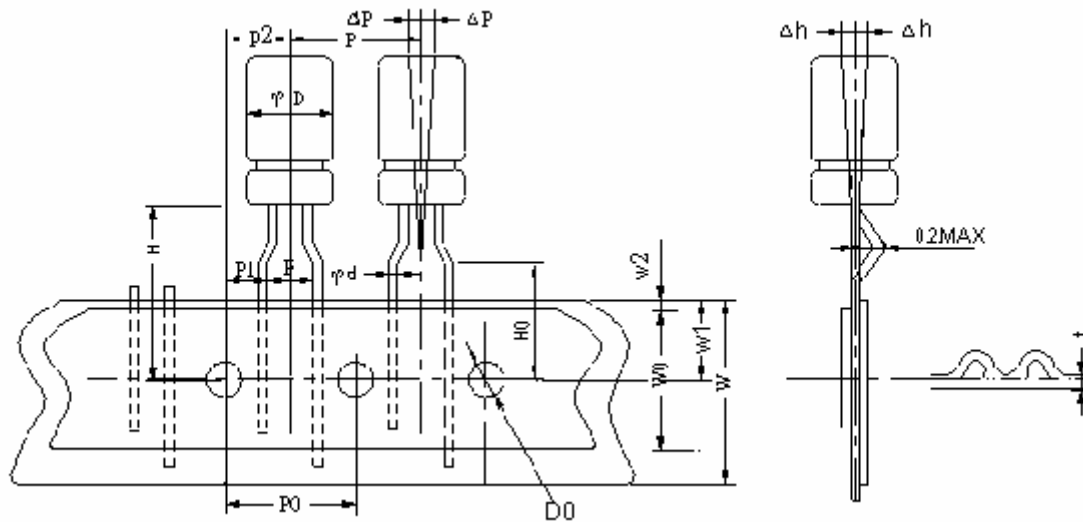

SYMBOL	CASE SIZE			TOLERANCE
	4x5	5x5~11	6.3x5~11	
ϕd	0.45	0.45 or 0.5		± 0.05
P	12.7			± 1.0
P0	12.7			± 0.3
P1	3.85			± 0.5
P2	6.35			± 1.0
F	5.0			+0.6 / -0.2
W	18.0			± 0.5
W0	12.0 min			-
W1	9.0			± 0.5
W2	2.0 max			-
H	18.5			± 0.75
H0	16.0			± 0.5
D0	4.0			± 0.3
ΔP	0.2 max			-
Δh	0.2 max			-
t	0.6			± 0.3

Code T1/R1 : Ammo / Reel Tape ($\phi 8$)

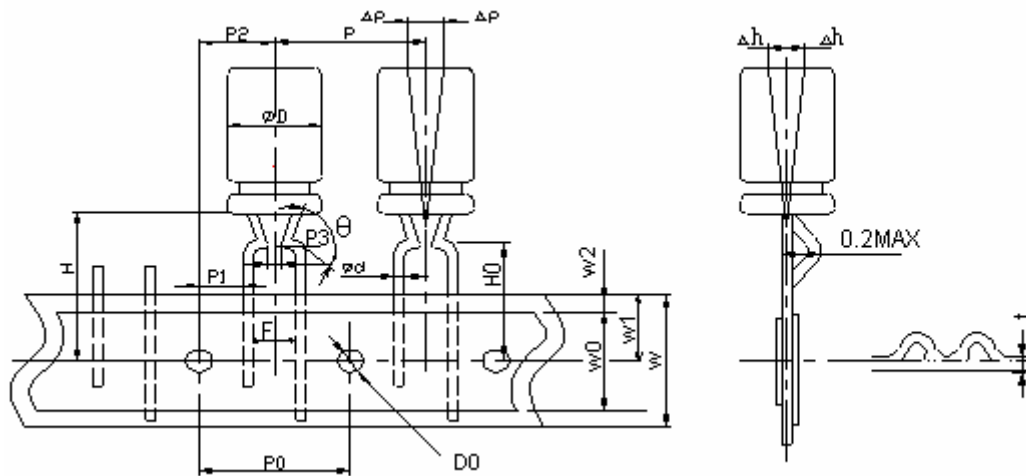

Unit: mm

SYMBOL	CASE SIZE	TOLERANCE
	8x5~20	
ϕd	0.45~0.6	± 0.05
P	12.7	± 1.0
P0	12.7	± 0.3
P1	3.85	± 0.7
P2	6.35	± 1.0
P3	2.5	+0.2 / -0.5
θ	110°	$\pm 15^\circ$
F	5.0	+0.6 / -0.2
W	18.0	± 0.5
W0	12.0 min	-
W1	9.0	± 0.5
W2	2.0 max	-
H	18.5	± 0.75
H0	16.0	± 0.5
D0	4.0	± 0.3
ΔP	0.2 max	-
Δh	0.2 max	-
t	0.6	± 0.3

Code T2/R2: Ammo/Reel Tape with straight lead

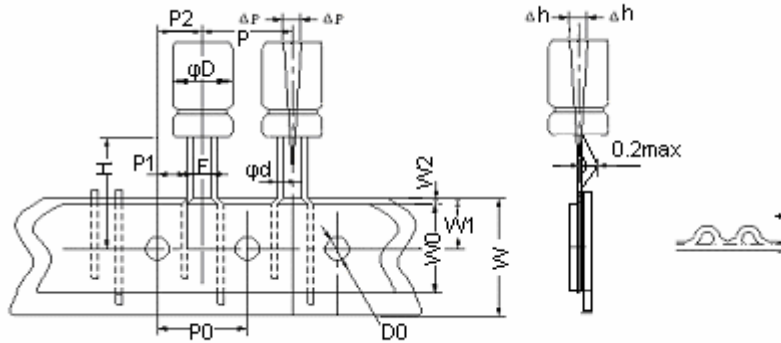

* F : Distance between the two leads after forming.

Dimension table(mm)

SYMBOL	CASE SIZE				TOLERANCE
	4×5~7	5×5~11	6.3×5~11	8×7~20	
φ d	0.45	0.45 or 0.5	0.5 or 0.6		±0.05
F	1.5	2.0	2.5	3.5	+0.6/-0.2
P1	5.60	5.35	5.10	4.6	±0.5
P0	12.7				±0.3
P	12.7				±1.0
P2	6.35				±1.0
W	18.0				±0.5
W0	12.0min				-
W1	9.0				±0.5
W2	3.0max				-
H	18.5				±0.75
D0	4.0				±0.3
△p	0.2max				-
t	0.6				±0.2

Code T4/R3: Ammo/Reel Formed Tape (ϕ 4~ ϕ 5/pitch2.5mm)

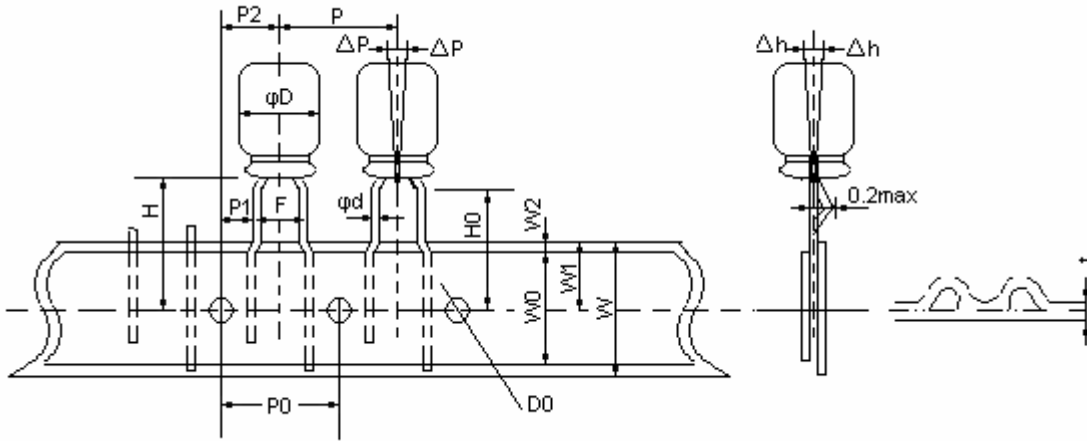

* F : Distance between the two leads after forming.

Dimension table(mm)

SYMBOL	CASE SIZE		TOLERANCE
	4×5~7	5×5~11	
φ d	0.45	0.45 or 0.5	±0.05
P	12.7		±1.0
P0	12.7		±0.3
P1	5.10		±0.5
P2	6.35		±1.0
F	2.5		+0.6/-0.2
W	18.0		±0.5
W0	12.0min		-
W1	9.0		±0.5
W2	2.0max		-
H	18.5		±0.75
H0	17.0		±0.5
D0	4.0		±0.3
ΔP	0.2max		-
Δh	0.2max		-
t	0.6		±0.2

ALUMINUM ELECTROLYTIC CAPACITORS

FX

**5mm height
Series**

■ Dimensions, Rated Ripple Current

Capacitance (μ F)	Rated (Surge) Voltage													
	4 (5)		6.3 (8)		10 (13)		16 (20)		25 (32)		35 (44)		50 (63)	
	Size	Ripple	Size	Ripple	Size	Ripple	Size	Ripple	Size	Ripple	Size	Ripple	Size	Ripple
1.0													4x5	9
2.2													4x5	13
3.3													4x5	17
4.7							4x5	20	4x5	16	4x5	18	4x5	17
													5x5	20
10			4x5	18	4x5	20	4x5	23	4x5	20	5x5	30	6.3x5	33
									5x5	27				
22	4x5	20	4x5	28	5x5	33	4x5	29	6.3x5	42	6.3x5	48	6.3x5	55
							5x5	37						
33	4x5	25	4x5	33	4x5	34	5x5	44	5x5	45				
					5x5	41	6.3x5	49	6.3x5	53				
47	5x5	30	4x5	35	5x5	46	5x5	54	5x5	55				
			5x5	45			6.3x5	58	6.3x5	65				
68					6.3x5	54								
100	6.3x5	50	5x5	55	6.3x5	80	6.3x5	85	8x5	90				
			6.3x5	70										
220	6.3x5	70	6.3x5	90										
330	8x5	110	8x5	115										
470			8x5	100										

☆ Size: D ϕ x L (mm) ☆ Ripple Current: (mA/rms), 105°C, 120