

FAN7527B

Power Factor Correction Controller

Features

- Internal start-up timer
- Internal R/C filter eliminates the need for an external R/C filter
- Very precise adjustable output over voltage protection
- Zero current detector
- One quadrant multiplier
- Trimmed 1.5% internal band gap reference
- Under voltage lockout with 3V of hysteresis
- Totem pole output with high state clamp
- Low start-up and operating current
- 8-Pin DIP or 8-Pin SOP

Applications

- Electronic ballast
- SMPS

Description

The FAN7527B provides simple and high performance active power factor correction. The FAN7527B is optimized for electronic ballasts and low power and high density power supplies which require minimum board size, reduced external components and low power dissipation. Because the R/C filter is included in the current sense block, the external R/C filter is not necessary. Special circuitry has also been added to prevent no load runaway conditions. Regardless of the supply voltage, the output drive clamping circuit limits the overshoot of the power MOSFET gate drive. It greatly enhances the system reliability.

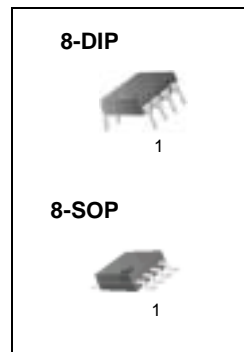

Internal Block Diagram

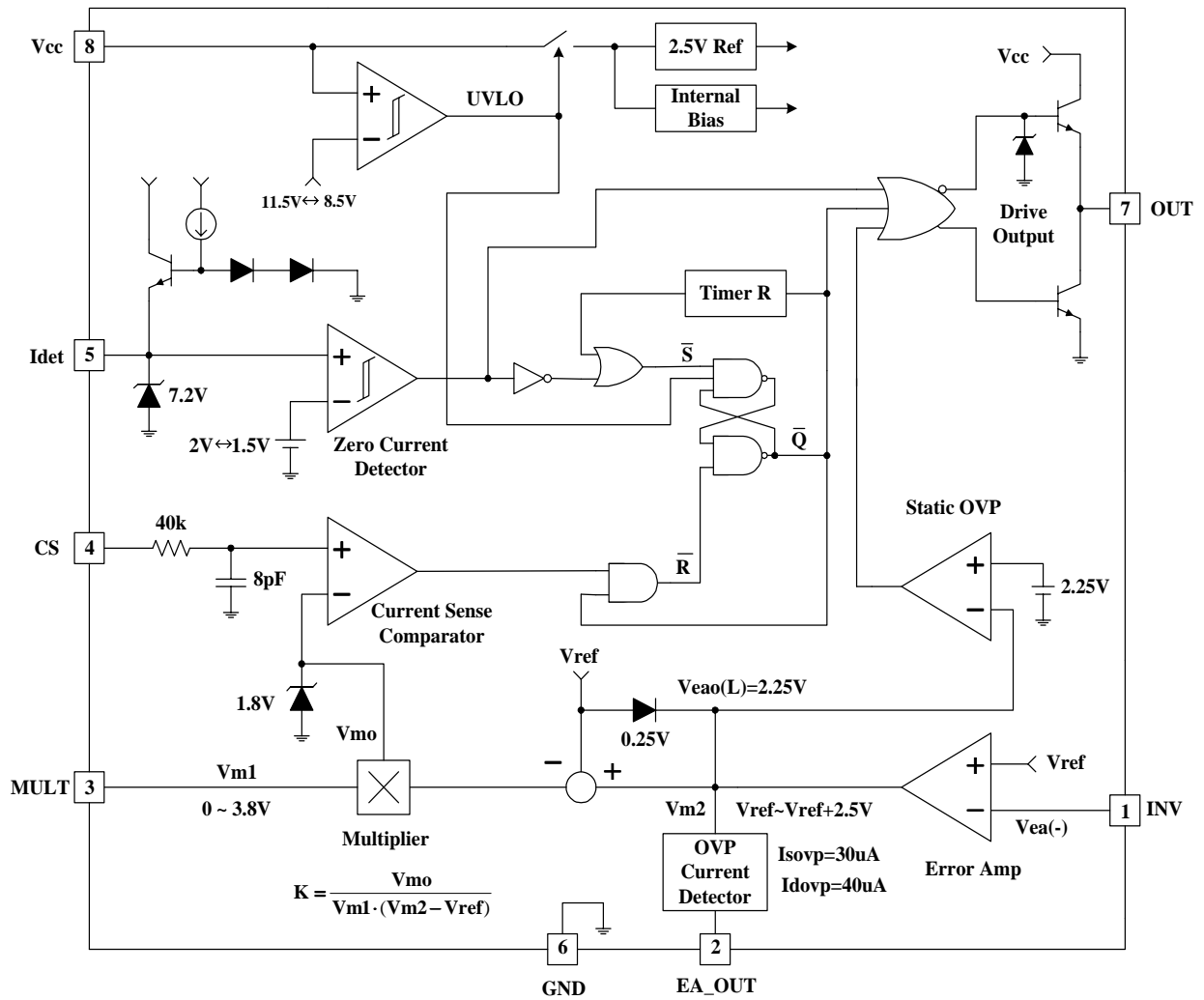

PIN Description

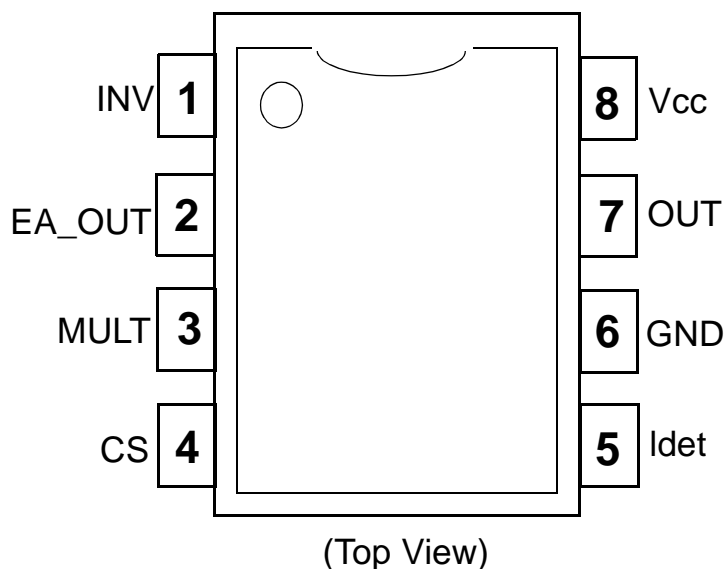

Pin Number	Pin Name	Pin Function Description
1	INV	Inverting input of the error amplifier. the output of the boost converter should be resistively divided to 2.5V and connected to this pin.
2	EA_OUT	The output of the error amplifier. a feedback compensation network is placed between this pin and the INV pin.
3	MULT	Input to the multiplier stage. the full-wave rectified ac voltage is divided to less than 2V and is connected to this pin.
4	CS	Input of the PWM comparator. the MOSFET current is sensed by a resistor and the resulting voltage is applied to this pin. an internal R/C filter is included to reject any high frequency noise.
5	Idet	Zero current detection input.
6	GND	The ground potential of all the pins.
7	OUT	Gate driver output. the push pull output stage is able to drive the power MOSFET with peak current of 500mA.
8	Vcc	Supply voltage of driver and control circuits.

Absolute Maximum Ratings (Ta=25°C)

Characteristics	Symbol	Value	Unit
Supply voltage	V _{CC}	30	V
Peak drive output current	I _{OH} , I _{OL}	±500	mA
Driver output clamping diodes V _o > V _{CC} or V _o < -0.3V	I _{clamp}	±10	mA
Detector clamping diodes	I _{det}	±10	mA
Error amp, multiplier and comparator input voltages	V _{in}	-0.3 to 6	V
Operating junction temperature	T _j	150	°C
Operating temperature range	T _{opr}	-25 to 125	°C
Storage temperature range	T _{stg}	-65 to 150	°C
Power dissipation	8-DIP	1.1	W
	8-SOP	0.8	

Thermal Data

Characteristics	Symbol	Value	Unit
Thermal resistance junction-ambient Max.	R _{θja}	110	°C/W
		150	

Temperature Characteristics (-25°C ≤ Ta ≤ 125°C)

Characteristics	Symbol	Min.	Typ.	Max.	Unit
Temperature stability for reference voltage (V _{ref})	ΔV _{ref}	-	20	-	mV
Temperature stability for multiplier gain (K)	ΔK/ΔT	-	-0.2	-	%/°C

Electrical Characteristics

V_{CC} = 14V, -25°C ≤ T_a ≤ 125°C, unless otherwise stated.

Characteristics	Symbol	Test Condition	Min.	Typ.	Max.	Unit
< UNDER VOLTAGE LOCKOUT SECTION >						
Start threshold voltage	V _{th(st)}	V _{CC} Increasing	10.5	11.5	12.5	V
UVLO hysteresis	HY(st)	-	2	3	4	V
< SUPPLY CURRENT SECTION >						
Start-up supply current	I _{st}	V _{CC} = V _{th(st)} - 0.2V	10	60	100	μA
Operating supply current	I _{CC}	Output not switching	-	3	6	mA
Operating current at OVP	I _{CC(OVP)}	V _{inv} = 3V	-	1.7	4	mA
Dynamic operating supply current	I _{dCC}	50kHz, C _I = 1nF	-	4	8	mA
< ERROR AMPLIFIER SECTION >						
Voltage feedback input threshold	V _{ref}	I _{ref} = 0mA, T _a = 25°C	2.465	2.5	2.535	V
		-25 ≤ T _a ≤ 125°C	2.44	2.5	2.56	V
Line regulation	ΔV _{ref1}	14V ≤ V _{CC} ≤ 25V	-	0.1	10	mV
Temperature stability of V _{ref} (Note1)	ΔV _{ref3}	-25 ≤ T _a ≤ 125°C	-	20	-	mV
Input bias current	I _{b(ea)}	-	-0.5	-	0.5	μA
Output source current	I _{source}	V _{m2} = 4V	-2	-4	-	mA
Output sink current	I _{sink}	V _{m2} = 4V	2	4	-	mA
Output upper clamp voltage (Note2)	V _{ea0(H)}	I _{source} = 0.1mA	-	6	-	V
Output lower clamp voltage (Note3)	V _{ea0(L)}	I _{sink} = 0.1mA	-	2.25	-	V
Large signal open loop gain (Note4)	G _v	-	60	80	-	dB
Power supply rejection ratio (Note5)	PSRR	14V ≤ V _{CC} ≤ 25V	60	80	-	dB
Unity gain bandwidth (Note6)	GBW	-	-	1	-	MHz
Slew rate (Note7)	SR	-	-	0.6	-	V/μs
< MULTIPLIER SECTION >						
Input bias current (pin3)	I _{b(m)}	-	-0.5	-	0.5	μA
M1 input voltage range (pin3)	ΔV _{m1}	-	0	-	3.8	V
M2 input voltage range (pin2)	ΔV _{m2}	-	V _{ref}	-	V _{ref} +2.5	V
Multiplier gain (Note8)	K	V _{m1} = 1V, V _{m2} = 3.5V	0.36	0.44	0.52	1/V
Maximum multiplier output voltage	V _{omax(m)}	V _{inv} = 0V, V _{m1} = 4V	1.65	1.8	1.95	V
Temperature stability of K (Note9)	ΔK/ΔT	-25 ≤ T _a ≤ 125°C	-	-0.2	-	%/°C

Electrical Characteristics (Continued)

VCC= 14V, -25°C ≤ Ta ≤ 125°C, unless otherwise stated.

Characteristics	Symbol	Test Condition	Min.	Typ.	Max.	Unit
< CURRENT SENSE SECTION >						
Input offset voltage (Note8)	V _{io(cs)}	V _{m1} =0V , V _{m2} = 2.2V	-10	3	10	mV
Input bias current	I _{b(cs)}	0V ≤ V _{cs} ≤ 1.7V	-1	-0.1	1	uA
Current sense delay to output (Note11)	t _{d(cs)}	-	-	200	500	ns
< ZERO CURRENT DETECT SECTION >						
Input voltage threshold	V _{th(det)}	V _{det} increasing	1.7	2	2.3	V
Detect hysteresis	H _{Y(det)}	-	0.2	0.5	0.8	V
Input low clamp voltage	V _{clamp(l)}	I _{det} = -100uA	0.45	0.75	1	V
Input high clamp voltage	V _{clamp(h)}	I _{det} = 3mA	6.5	7.2	7.9	V
Input bias current	I _{b(det)}	1V ≤ V _{det} ≤ 5V	-1	-0.1	1	uA
Input high/low clamp diode current (Note12)	I _{clamp(d)}	-	-	-	±3	mA
< OUTPUT SECTION >						
Output voltage high	V _{oh}	I _o = -10mA	10.5	11	-	V
Output voltage low	V _{ol}	I _o = 10mA	-	0.8	1	V
Rising time (Note13)	t _r	CI = 1nF	-	130	200	ns
Falling time (Note14)	t _f	CI = 1nF	-	50	120	ns
Maximum output voltage	V _{omax(o)}	V _{cc} = 20V, I _o = 100uA	12	14	16	V
Output voltage with UVLO activated	V _{omin(o)}	V _{cc} = 5V , I _o = 100uA	-	-	1	V
< RESTART TIMER SECTION >						
Restart time delay	t _{d(rst)}	V _{m1} = 1V, V _{m2} = 3.5V	-	150	-	us
<OVER VOLTAGE PROTECTION SECTION >						
Soft OVP detecting current	I _{sovp}	-	25	30	35	uA
Dynamic OVP detecting current	I _{dovp}	-	35	40	45	uA
Static OVP threshold voltage	V _{ovp}	V _{inv} = 2.7V	2.1	2.25	2.4	V

Note 1 ~ 14: These parameters, although guaranteed, are not 100% tested in production.

$$\text{Multiplier Gain: } K = \frac{\text{Pin4_Threshold}}{V_{m1} \times (V_{m2} - V_{ref})} \dots\dots (V_{m1} = V_{pin3}, V_{m2} = V_{pin2})$$

Typical Performance Characteristics

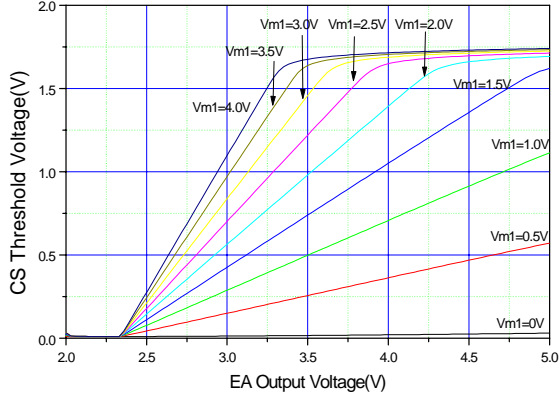

Figure 1. Error Amplifier Output Voltage vs Current Sensing Threshold

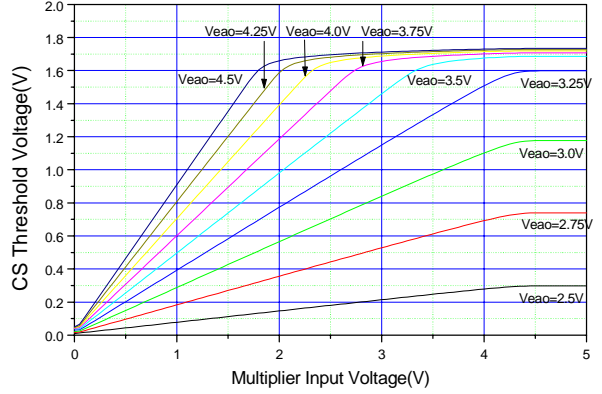

Figure 2. Multiplier Input Voltage vs Current Sensing Threshold

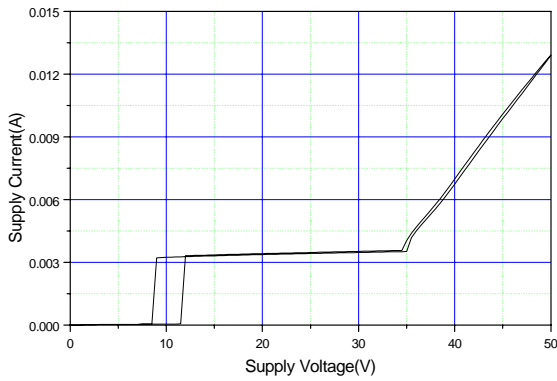

Figure 3. Supply Current vs Supply Voltage

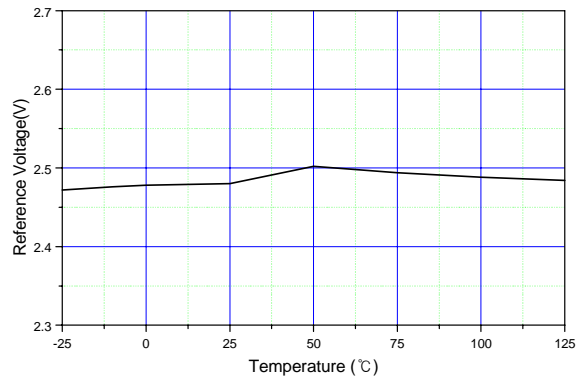

Figure 4. Reference Voltage vs Temperature

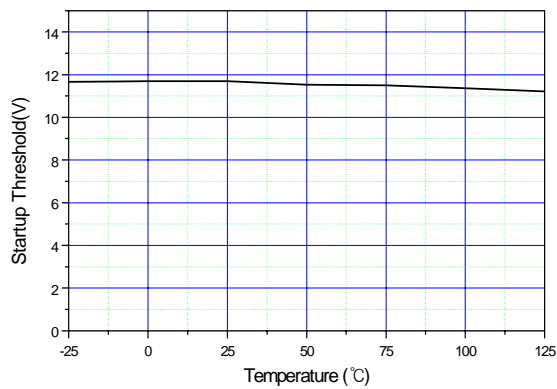

Figure 5. Start-Up Threshold vs Temperature

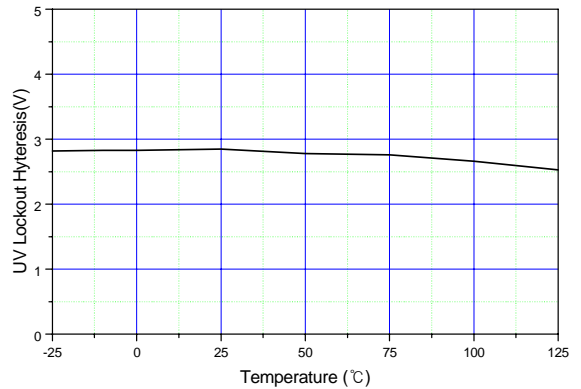

Figure 6. UV Lockout Hysteresis vs Temperature

Typical Performance Characteristics (Continued)

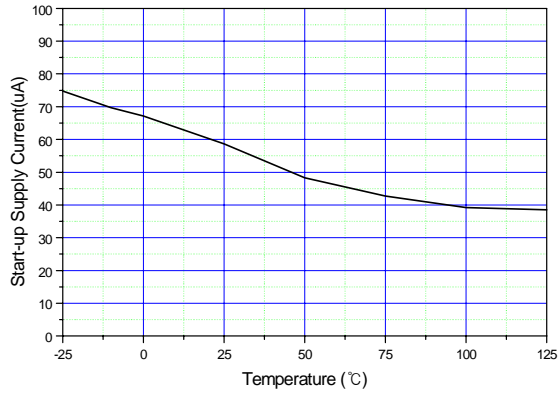

Figure 7. Start-Up Supply Current vs Temperature

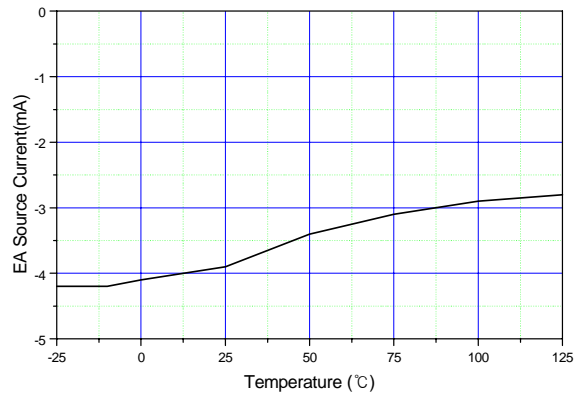

Figure 8. Error Amplifier Source Current vs Temperature

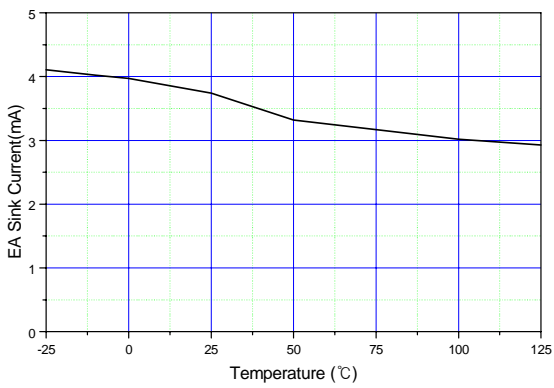

Figure 9. Error Amplifier Sink Current vs Temperature

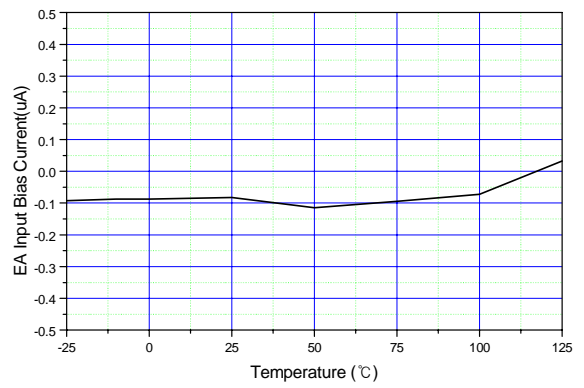

Figure 10. Error Amplifier Input Bias Current vs Temperature

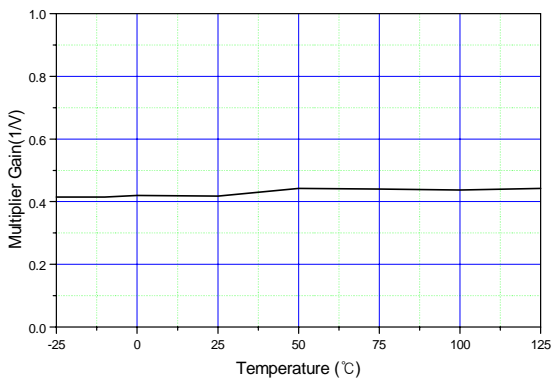

Figure 11. Multiplier Gain vs Temperature

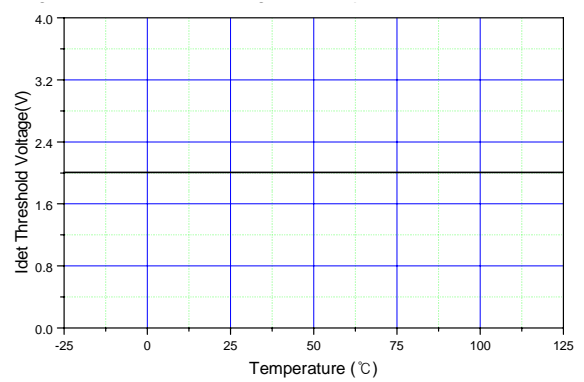

Figure 12. Idet Threshold Voltage vs Temperature

Typical Performance Characteristics (Continued)

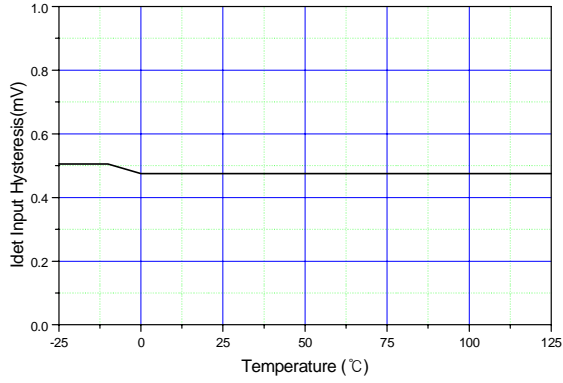

Figure 13. Idet Input Hysteresis vs Temperature

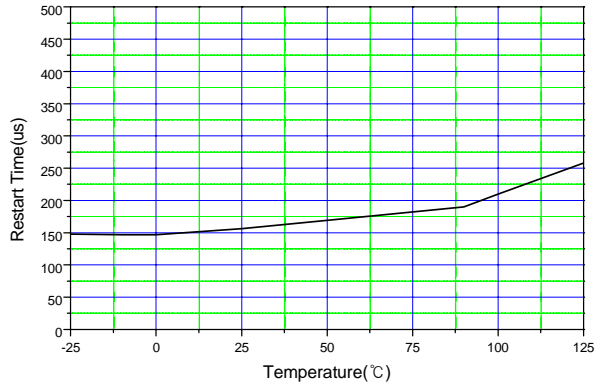

Figure 14. Restart Time vs Temperature

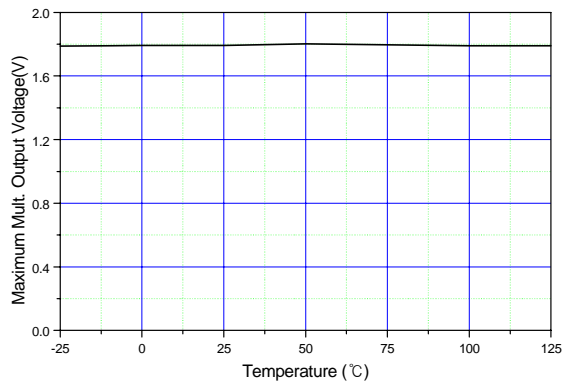

Figure 15. Max.Mult.Output Voltage vs Temperature

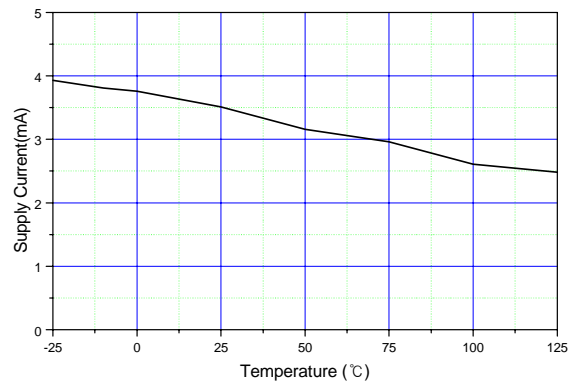

Figure 16. Supply Current vs Temperature

Mechanical Dimensions

Package

Dimensions in millimeters

8-DIP

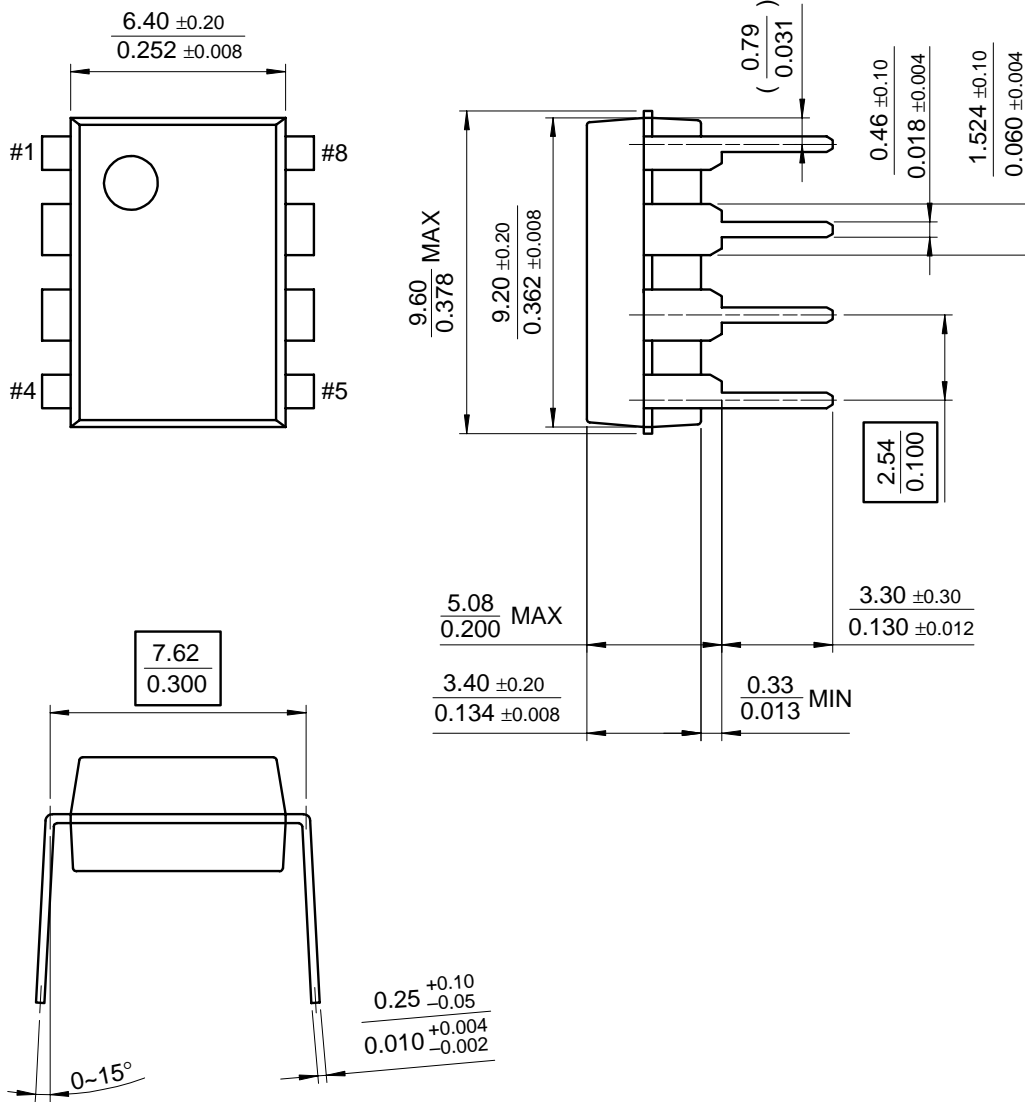

Mechanical Dimensions (Continued)

Package

Dimensions in millimeters

8-SOP

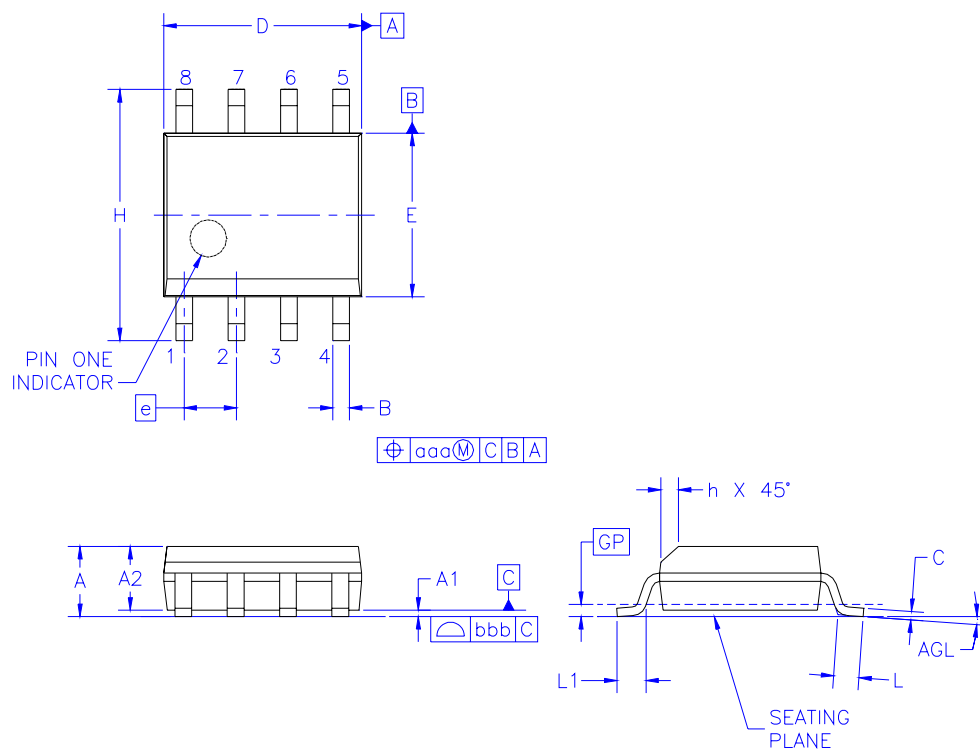

Symbol	Min	Nom	Max
A	-	-	1.75
A1	0.10	0.15	0.25
A2	1.25	1.45	1.50
B	0.35	0.37	0.51
C	0.19	0.20	0.25
D	4.80	4.90	5.00
E	3.80	3.90	4.00
e	1.27BSC		
H	5.79	5.99	6.20
h	0.25	-	0.50
L	0.50	0.70	0.90
GP	0.36 BSC		
q	0	-	8
aaa	-	-	0.25
bbb	-	-	0.10

Ordering Information

Product Number	Package	Operating Temperature
FAN7527BN	8-DIP	-25 ~ +125°C
FAN7527BM	8-SOP	

DISCLAIMER

FAIRCHILD SEMICONDUCTOR RESERVES THE RIGHT TO MAKE CHANGES WITHOUT FURTHER NOTICE TO ANY PRODUCTS HEREIN TO IMPROVE RELIABILITY, FUNCTION OR DESIGN. FAIRCHILD DOES NOT ASSUME ANY LIABILITY ARISING OUT OF THE APPLICATION OR USE OF ANY PRODUCT OR CIRCUIT DESCRIBED HEREIN; NEITHER DOES IT CONVEY ANY LICENSE UNDER ITS PATENT RIGHTS, NOR THE RIGHTS OF OTHERS.

LIFE SUPPORT POLICY

FAIRCHILD'S PRODUCTS ARE NOT AUTHORIZED FOR USE AS CRITICAL COMPONENTS IN LIFE SUPPORT DEVICES OR SYSTEMS WITHOUT THE EXPRESS WRITTEN APPROVAL OF THE PRESIDENT OF FAIRCHILD SEMICONDUCTOR CORPORATION. As used herein:

1. Life support devices or systems are devices or systems which, (a) are intended for surgical implant into the body, or (b) support or sustain life, and (c) whose failure to perform when properly used in accordance with instructions for use provided in the labeling, can be reasonably expected to result in a significant injury of the user.
2. A critical component in any component of a life support device or system whose failure to perform can be reasonably expected to cause the failure of the life support device or system, or to affect its safety or effectiveness.