

FAN7601B

Green Current Mode PWM Controller

Features

- Green Current Mode PWM Control
- Low Operating Current: Maximum 4mA
- Burst Mode Operation
- Internal High-Voltage Startup Switch
- Under-Voltage Lockout (UVLO): 12V/8V
- Latch Protection and Soft-Start Function
- Over-Voltage Protection: 19V
- Operating Frequency up to 300kHz
- Maximum Duty Cycle: 95%

Applications

- Offline Adapter Applications
- Auxiliary Power Supplies

Related Resources

- *AN4129 — Green Current Mode PWM Controller FAN7601*

Description

The FAN7601B is a programmable frequency green current mode PWM controller. It is specially designed for the offline adapter applications and the auxiliary power supplies that require high efficiency at light load and no load. The internal high-voltage startup switch and burst mode reduce the power loss.

FAN7601B includes protections, such as latch protection and over-voltage protection. The latch protection can be used for over-voltage protection, thermal protection, and others. The soft-start prevents the output voltage overshoot at startup.

Ordering Information

Part Number	Operating Junction Temperature	Top Mark	 Eco Status	Package	Packing Method
FAN7601BN	-40°C to +150°C	FAN7601B	RoHS	8-DIP	Rail
FAN7601BM		7601B		8-SOP	Rail
FAN7601BMX		7601B		8-SOP	Tape & Reel
FAN7601BG		7601B		10-SSOP	Rail
FAN7601BGX		7601B		10-SSOP	Tape & Reel

 For Fairchild's definition of "green" Eco Status, please visit: http://www.fairchildsemi.com/company/green/rohs_green.html.

Block Diagram

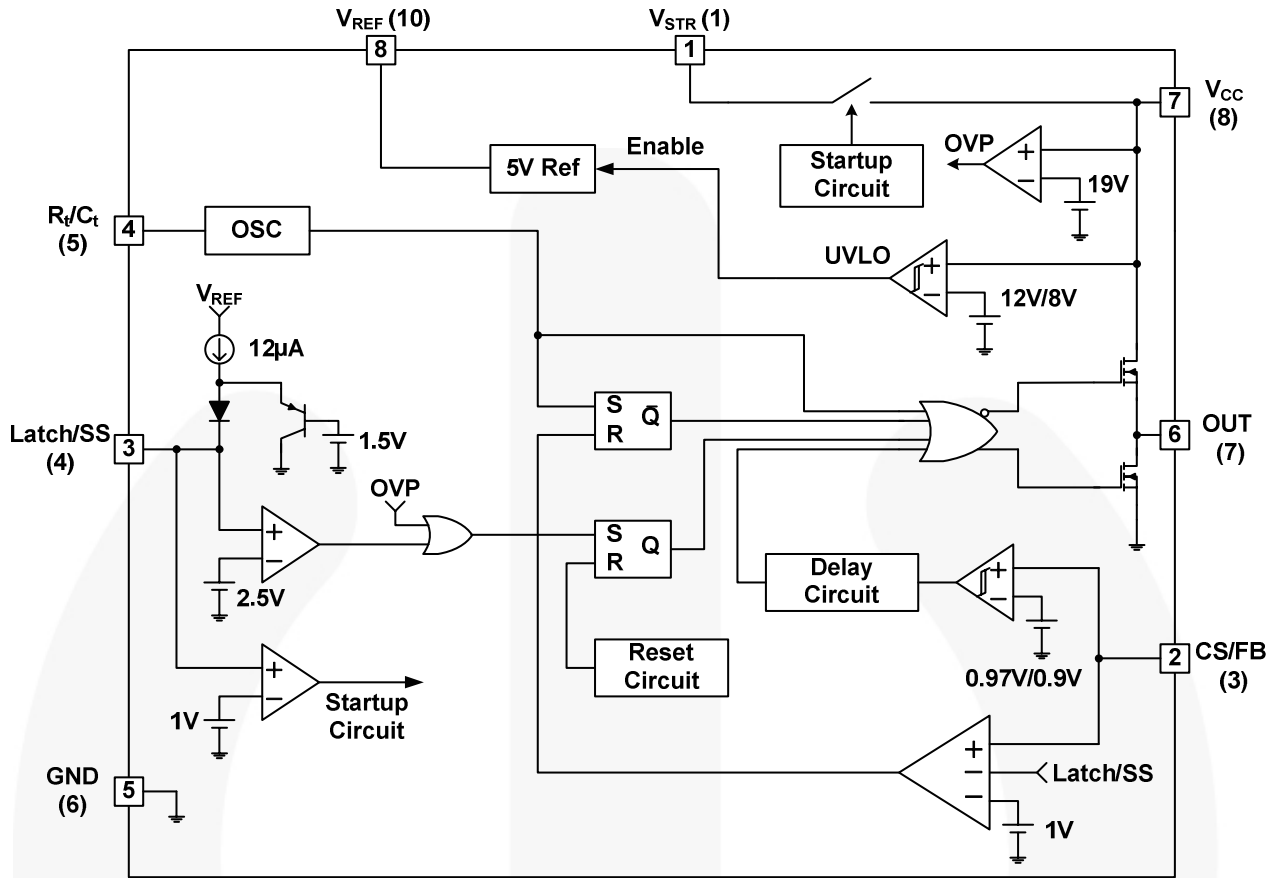

Figure 1. Internal Block Diagram

* () is 10-SSOP Pin Number

Pin Configurations

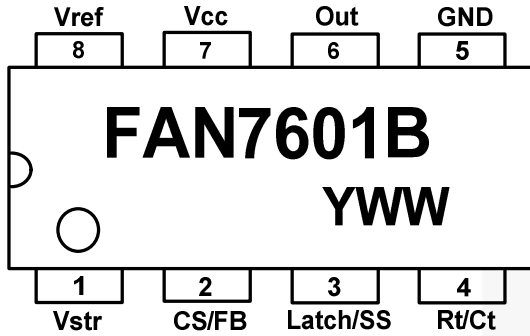

Figure 2. 8-Pin Configuration (Top View)

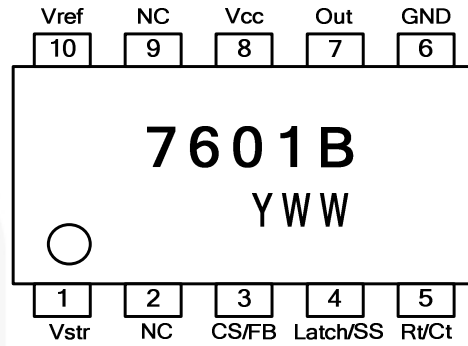

Figure 3. 10-Pin Configuration (Top View)

Pin Definitions

Pin # (8-Pin)	Pin # (10-Pin)	Name	Description
1	1	Vstr	Startup
2	3	CS/FB	Current Sense and Feedback
3	4	Latch/SS	Latch Protection and Soft-Start
4	5	Rt/Ct	Oscillator Timing
5	6	GND	Ground
6	7	Out	Gate Drive Output
7	8	Vcc	IC Power Supply
8	10	Vref	Voltage Reference

Absolute Maximum Ratings

Stresses exceeding the absolute maximum ratings may damage the device. The device may not function or be operable above the recommended operating conditions and stressing the parts to these levels is not recommended. In addition, extended exposure to stresses above the recommended operating conditions may affect device reliability. The absolute maximum ratings are stress ratings only.

Symbol	Parameter	Min.	Max.	Unit
V_{CC}	Supply Voltage		20	V
$V_{CS/FB}$	Input Voltage CS/FB	-0.3	20.0	V
T_{STG}	Storage Temperature	-55	+150	°C
T_J	Recommended Operating Junction Temperature	-40	+150	°C
I_O	Output Current		250	mA
V_{STR}	V_{STR} Input Voltage		500	V
V_{ESD_HBM}	Electrostatic Discharge Capability, Human Body Model JESD22-A114 (All pins except V_{STR} pin)		2	kV
V_{ESD_MM}	Electrostatic Discharge Capability, Machine Model, JESD22-A115		300	V

Thermal Impedance

Symbol	Parameter		Value	Unit
θ_{JA}	Thermal Resistance, Junction-to-Ambient	8-DIP	100	°C/W
		8-SOP	180	
		10-SSOP	130	

Electrical Characteristics

$T_A = -25^{\circ}\text{C} \sim 125^{\circ}\text{C}$, $V_{CC} = 14\text{V}$, $R_T = 9.5\text{k}\Omega$, $C_T = 2.2\text{nF}$ unless otherwise specified.

Symbol	Parameter	Conditions	Min.	Typ.	Max.	Unit
Reference Section						
V_{REF}	Reference Output Voltage	$I_O = 1\text{mA}$	4.85	5.00	5.15	V
ΔV_{REF1}	Line Regulation	$V_{CC} = 10\text{V} \sim 18\text{V}$		10	20	mV
ΔV_{REF2}	Load Regulation	$I_O = 1\text{mA} \sim 10\text{mA}$		20	30	mV
Oscillator Section						
f_{OSC}	Initial Accuracy		90	100	110	kHz
ST_V	Voltage Stability	$V_{CC} = 10\text{V} \sim 18\text{V}$		1.0	1.5	%
V_{OSC}	Amplitude	V_{pin4} peak-to-peak		1.25		V
PWM Section						
$V_{CS/FB1}$	CS/FB Threshold Voltage ¹		0.9	1.0	1.1	V
D_{MAX}	Maximum Duty Cycle	$T_A = 25^{\circ}\text{C}$	92	95	98	%
D_{MIN}	Minimum Duty Cycle				0	%
Burst Mode Section						
$V_{CS/FB2}$	CS/FB Threshold Voltage ²⁽¹⁾		0.77	0.97	1.17	V
$V_{CS/FB3}$	CS/FB Threshold Voltage ³⁽¹⁾		0.7	0.9	1.1	V
Soft-Start Section						
I_{SS}	Soft-Start Current	$V_{pin3} = \text{GND}$	9	12	15	μA
V_{SL}	Soft-Start Limit Voltage ⁽²⁾	$I_{SS} = 1\mu\text{A}$	1.2	1.5	1.8	V
Protection Section						
V_{LATCH}	Latch Voltage		2.25	2.50	2.75	V
V_{OVP}	Over-Voltage Protection		18	19	20	V
UVLO Section						
V_{TH}	Start Threshold Voltage		11	12	13	V
V_{TL}	Minimum Operating Voltage		7	8	9	V
Total Current Section						
I_{OP}	Operating Supply Current			3	4	mA
Output Section						
V_{OL}	Low Output Voltage	$T_A = 25^{\circ}\text{C}$, $I_O = 100\text{mA}$		2.0	2.5	V
V_{OH}	High Output Voltage	$T_A = 25^{\circ}\text{C}$, $I_O = -100\text{mA}$	11.5	12.0	14.0	V
t_r	Rising Time ⁽¹⁾	$T_A = 25^{\circ}\text{C}$, $C_I = 1\text{nF}$		45	150	ns
t_f	Falling Time ⁽¹⁾	$T_A = 25^{\circ}\text{C}$, $C_I = 1\text{nF}$		35	150	ns
Startup Section						
I_{STR}	V_{STR} Startup Current	$V_{STR} = 30\text{V}$, $T_A = 25^{\circ}\text{C}$	0.5	1.0	1.5	mA

Notes:

- These parameters, although guaranteed, are not 100% tested in production.
- It is recommended to connect a $1\text{M}\Omega$ resistor between the Latch/SS pin and GND to prevent abnormal operation of the latch protection by noise coupling.

Typical Performance Characteristics

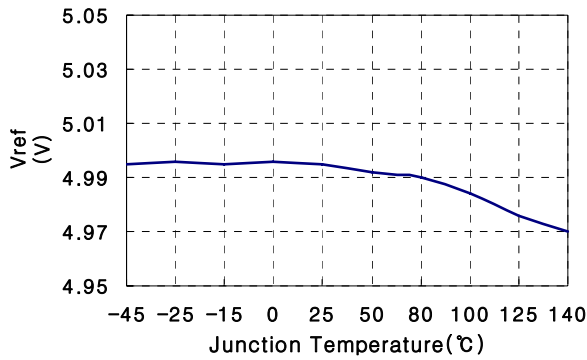

Figure 4. Trimmed Reference Voltage

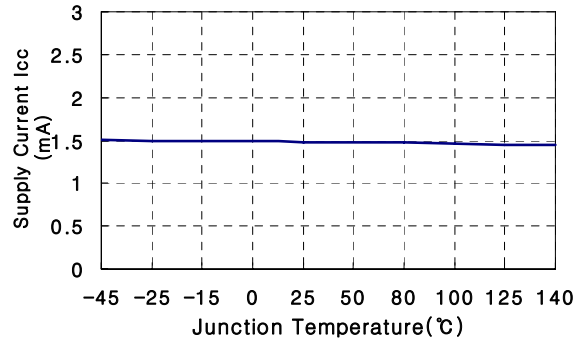

Figure 5. Supply Current

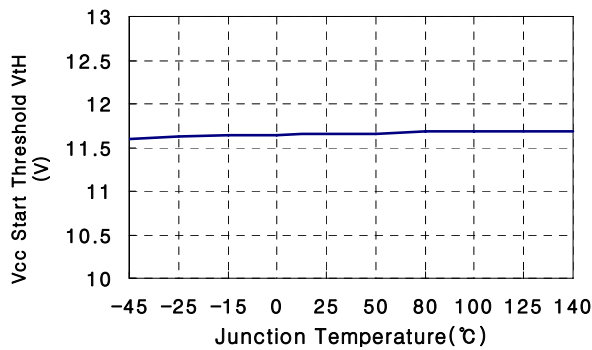

Figure 6. V_{CC} Start Threshold Voltage

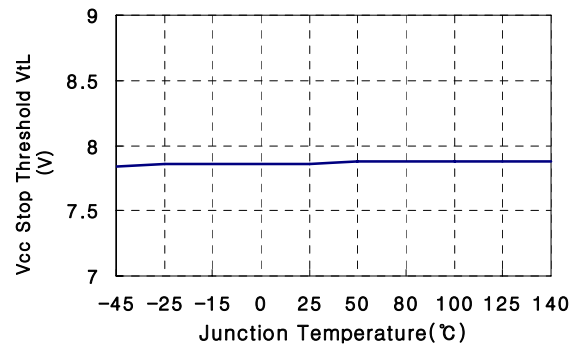

Figure 7. V_{CC} Stop Threshold Voltage

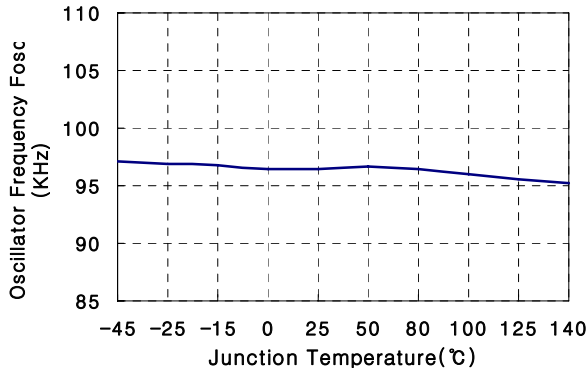

Figure 8. Oscillator Frequency

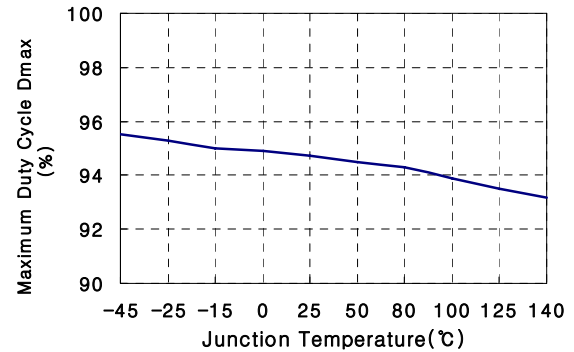

Figure 9. Maximum Duty Cycle

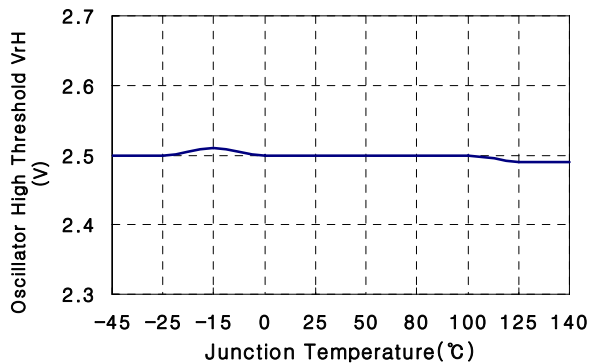

Figure 10. Oscillator High Threshold Voltage

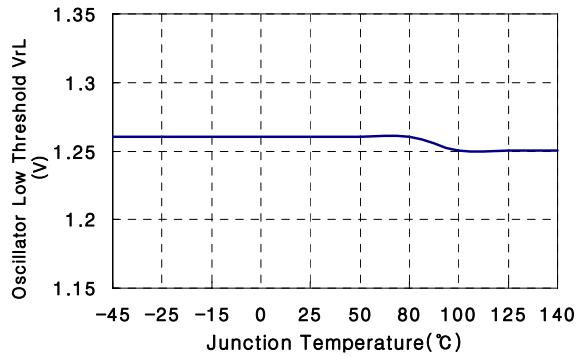

Figure 11. Oscillator Low Threshold Voltage

Typical Performance Characteristics (Continued)

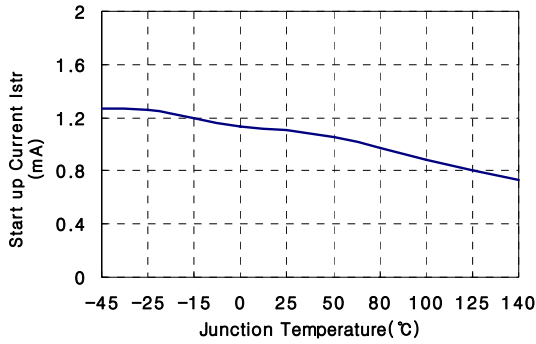

Figure 12. Startup Current

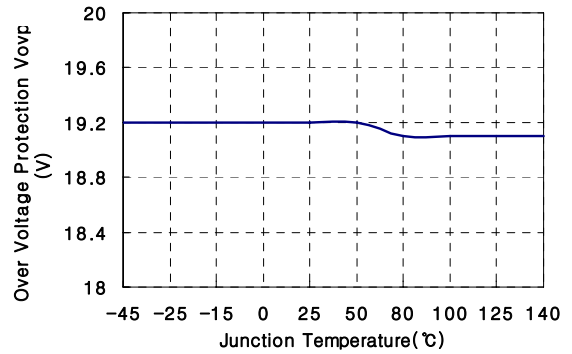

Figure 13. Over-Voltage Protection Level

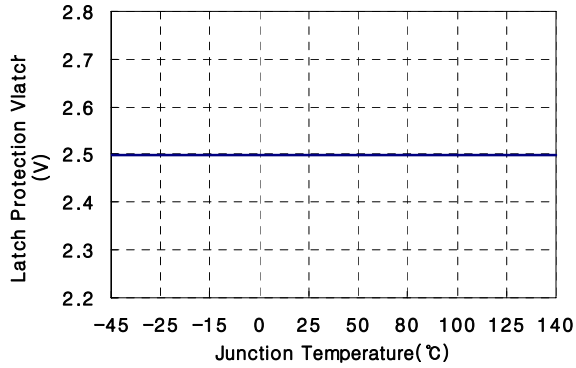

Figure 14. Latch Protection Voltage

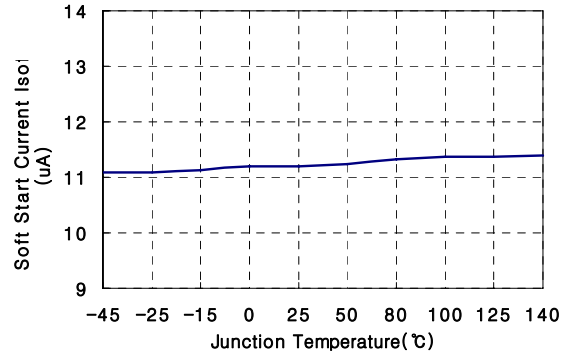

Figure 15. Soft-Start Current

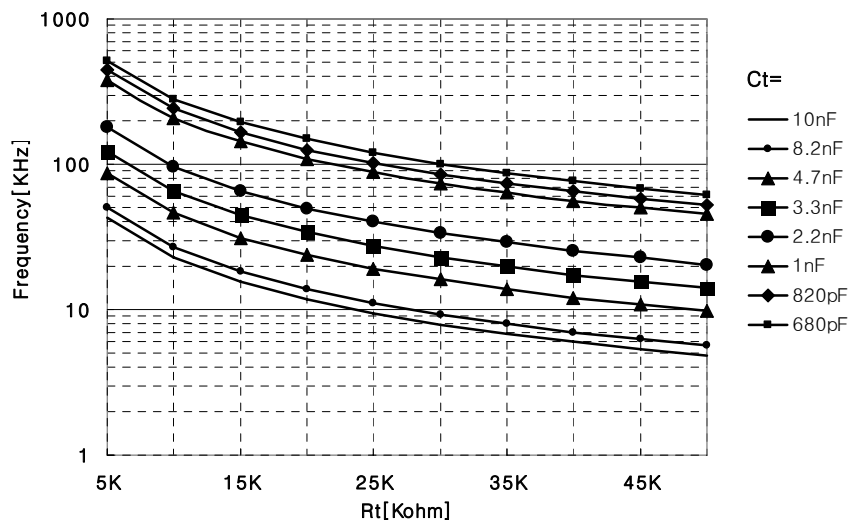
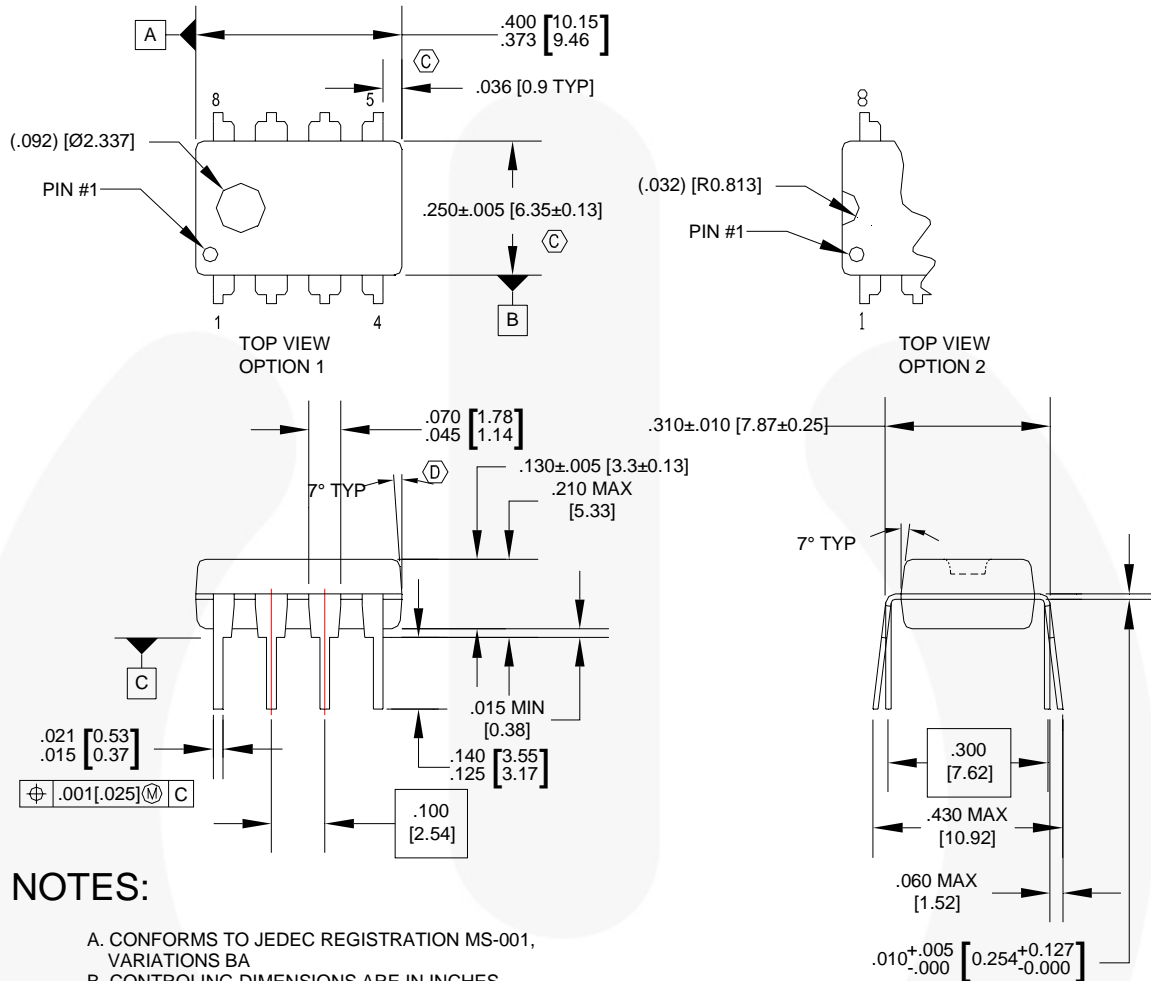

Figure 16. Oscillator Frequency Characteristic

Physical Dimensions



NOTES:

- A. CONFORMS TO JEDEC REGISTRATION MS-001, VARIATIONS BA
- B. CONTROLLING DIMENSIONS ARE IN INCHES
REFERENCE DIMENSIONS ARE IN MILLIMETERS
- C. DOES NOT INCLUDE MOLD FLASH OR PROTRUSIONS.
MOLD FLASH OR PROTRUSIONS SHALL NOT EXCEED
.010 INCHES OR 0.25MM.
- D. DOES NOT INCLUDE DAMBAR PROTRUSIONS.
DAMBAR PROTRUSIONS SHALL NOT EXCEED
.010 INCHES OR 0.25MM.
- E. DIMENSIONING AND TOLERANCING
PER ASME Y14.5M-1994.

N08EREVG

Figure 17. 8-Lead, Dual In-line Package (DIP)

Package drawings are provided as a service to customers considering Fairchild components. Drawings may change in any manner without notice. Please note the revision and/or date on the drawing and contact a Fairchild Semiconductor representative to verify or obtain the most recent revision. Package specifications do not expand the terms of Fairchild's worldwide terms and conditions, specifically the warranty therein, which covers Fairchild products.

Always visit Fairchild Semiconductor's online packaging area for the most recent package drawings:

<http://www.fairchildsemi.com/packaging/>

Physical Dimensions

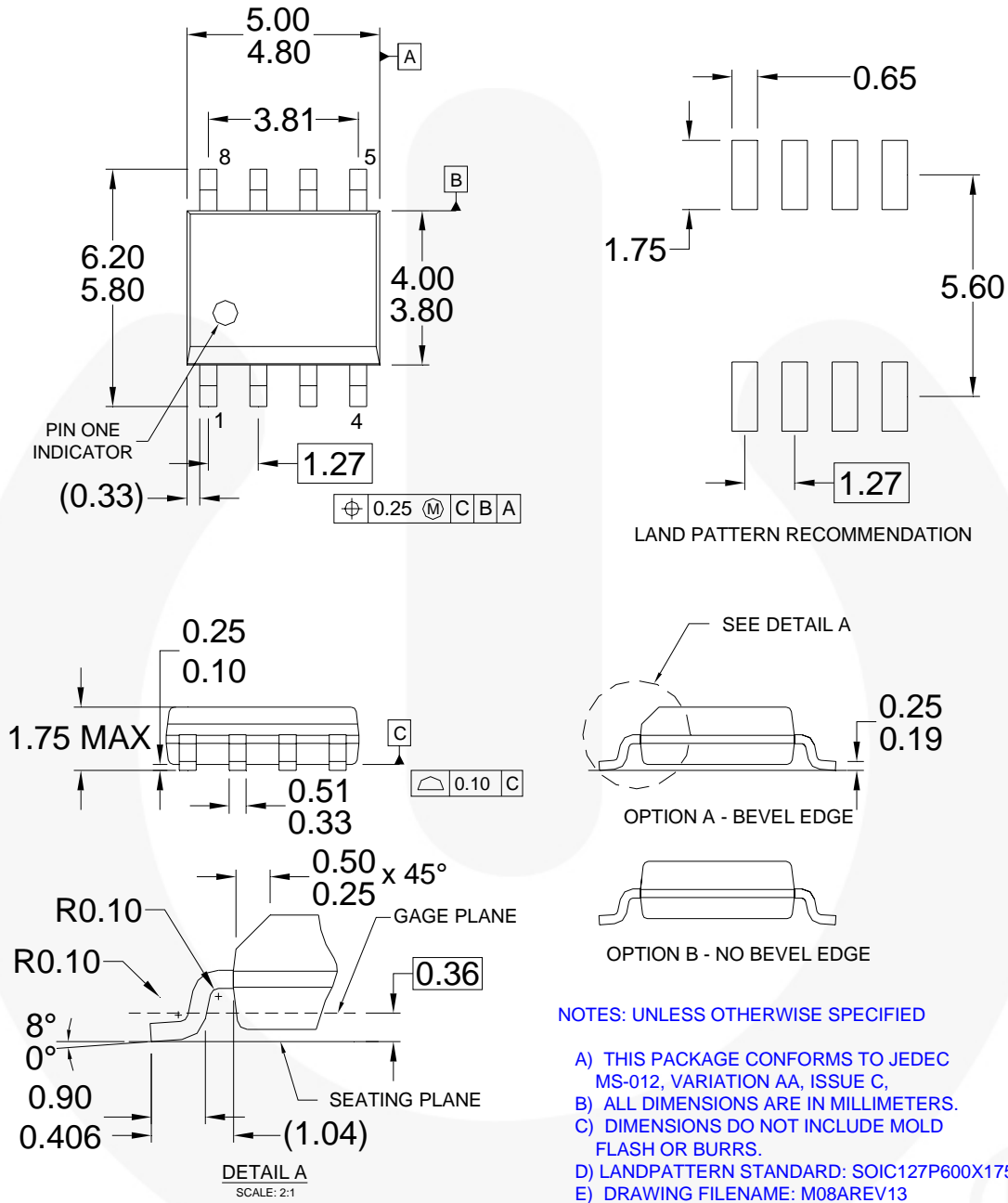

Figure 18. 8-Lead, Small Outline Package (SOP)

Package drawings are provided as a service to customers considering Fairchild components. Drawings may change in any manner without notice. Please note the revision and/or date on the drawing and contact a Fairchild Semiconductor representative to verify or obtain the most recent revision. Package specifications do not expand the terms of Fairchild's worldwide terms and conditions, specifically the warranty therein, which covers Fairchild products.

Always visit Fairchild Semiconductor's online packaging area for the most recent package drawings:
<http://www.fairchildsemi.com/packaging/>.

Physical Dimensions

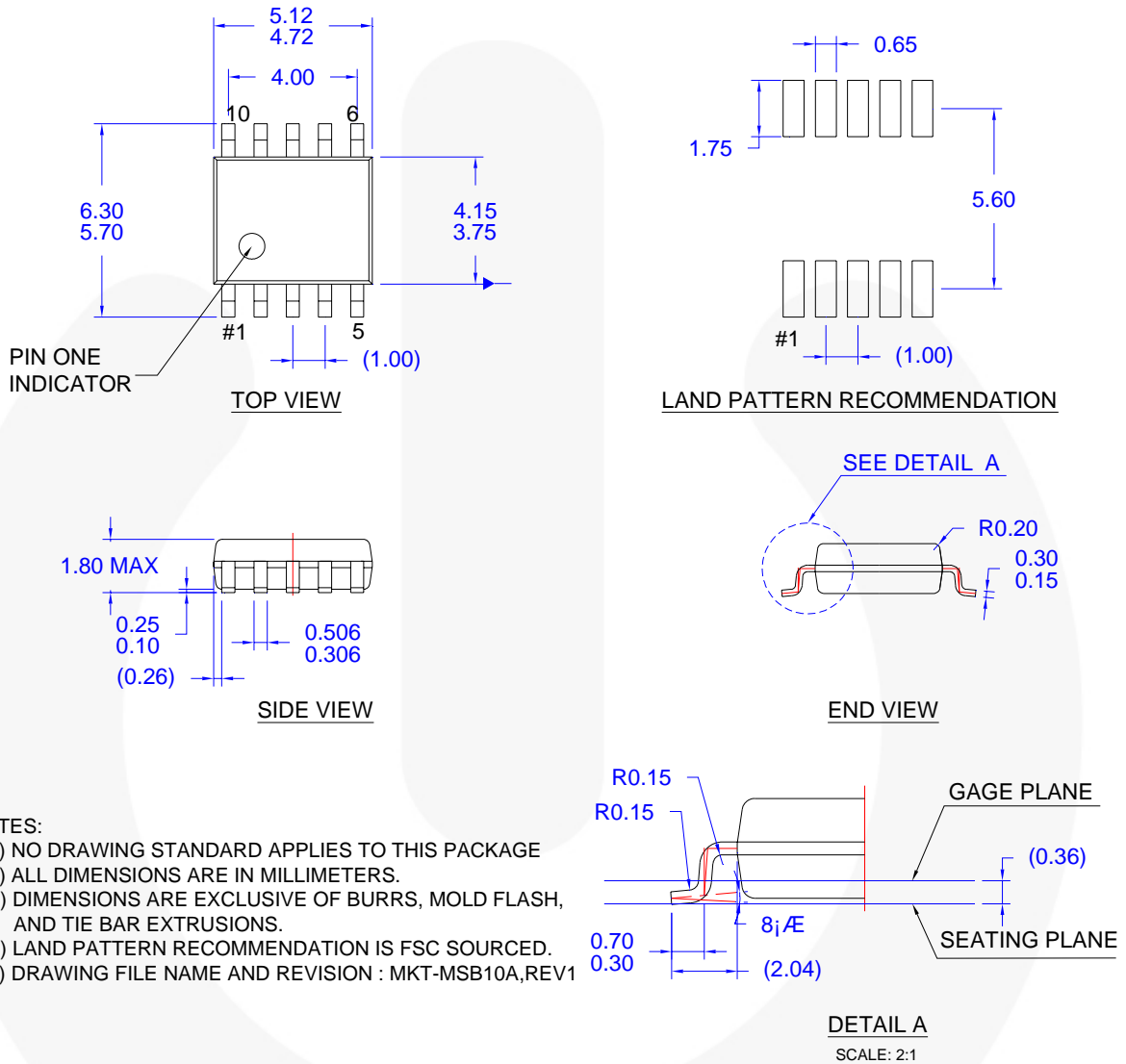

Figure 19. 10-Lead, Small Outline Package (SSOP)

Package drawings are provided as a service to customers considering Fairchild components. Drawings may change in any manner without notice. Please note the revision and/or date on the drawing and contact a Fairchild Semiconductor representative to verify or obtain the most recent revision. Package specifications do not expand the terms of Fairchild's worldwide terms and conditions, specifically the warranty therein, which covers Fairchild products.

Always visit Fairchild Semiconductor's online packaging area for the most recent package drawings:
<http://www.fairchildsemi.com/packaging/>



TRADEMARKS

The following includes registered and unregistered trademarks and service marks, owned by Fairchild Semiconductor and/or its global subsidiaries, and is not intended to be an exhaustive list of all such trademarks.

Build it Now™	FRFET®	Programmable Active Droop™	 TinyBoost™ TinyBuck™ TinyLogic® TINYOPTO™ TinyPower™ TinyPWM™ TinyWire™ TriFault Detect™ µSerDes™  UHC® Ultra FRFET™ UniFET™ VCX™ VisualMax™ XS™
CorePLUS™	Global Power Resource SM	QFET®	
CorePOWER™	Green FPST™	QST™	
CROSSVOLT™	Green FPST™ e-Series™	Quiet Series™	
CTL™	GTO™	RapidConfigure™	
Current Transfer Logic™	IntelliMAX™	 ™	
EcoSPARK®	ISOPLANAR™	Saving our world, 1mW/W/KW at a time™	
EfficientMax™	MegaBuck™	SmartMax™	
EZSWITCH™*	MICROCOUPLER™	SMART START™	
 ™	MicroFET™	SPM®	
 ®	MicroPak™	STEALTH™	
Fairchild®	MillerDrive™	SuperFET™	
Fairchild Semiconductor®	MotionMax™	SuperSOT™.3	
FACT Quiet Series™	Motion-SPM™	SuperSOT™.6	
FACT®	OPTOLOGIC®	SuperSOT™.8	
FAST®	OPTOPLANAR®	SupreMOS™	
FastvCore™	 ™	SyncFET™	
FlashWriter®*	PDP SPM™	 SYSTEM GENERAL	
FPST™	Power-SPM™	The Power Franchise®	
F-PFST™	PowerTrench®		
	PoweriXS™		

* EZSWITCH™ and FlashWriter® are trademarks of System General Corporation, used under license by Fairchild Semiconductor.

DISCLAIMER

FAIRCHILD SEMICONDUCTOR RESERVES THE RIGHT TO MAKE CHANGES WITHOUT FURTHER NOTICE TO ANY PRODUCTS HEREIN TO IMPROVE RELIABILITY, FUNCTION, OR DESIGN. FAIRCHILD DOES NOT ASSUME ANY LIABILITY ARISING OUT OF THE APPLICATION OR USE OF ANY PRODUCT OR CIRCUIT DESCRIBED HEREIN; NEITHER DOES IT CONVEY ANY LICENSE UNDER ITS PATENT RIGHTS, NOR THE RIGHTS OF OTHERS. THESE SPECIFICATIONS DO NOT EXPAND THE TERMS OF FAIRCHILD'S WORLDWIDE TERMS AND CONDITIONS, SPECIFICALLY THE WARRANTY THEREIN, WHICH COVERS THESE PRODUCTS.

LIFE SUPPORT POLICY

FAIRCHILD'S PRODUCTS ARE NOT AUTHORIZED FOR USE AS CRITICAL COMPONENTS IN LIFE SUPPORT DEVICES OR SYSTEMS WITHOUT THE EXPRESS WRITTEN APPROVAL OF FAIRCHILD SEMICONDUCTOR CORPORATION.

As used herein:

- Life support devices or systems are devices or systems which, (a) are intended for surgical implant into the body or (b) support or sustain life, and (c) whose failure to perform when properly used in accordance with instructions for use provided in the labeling, can be reasonably expected to result in a significant injury of the user.
- A critical component in any component of a life support, device, or system whose failure to perform can be reasonably expected to cause the failure of the life support device or system, or to affect its safety or effectiveness.

ANTI-COUNTERFEITING POLICY

Fairchild Semiconductor Corporation's Anti-Counterfeiting Policy. Fairchild's Anti-Counterfeiting Policy is also stated on our external website, www.fairchildsemi.com, under Sales Support.

Counterfeiting of semiconductor parts is a growing problem in the industry. All manufacturers of semiconductor products are experiencing counterfeiting of their parts. Customers who inadvertently purchase counterfeit parts experience many problems such as loss of brand reputation, substandard performance, failed applications, and increased cost of production and manufacturing delays. Fairchild is taking strong measures to protect ourselves and our customers from the proliferation of counterfeit parts. Fairchild strongly encourages customers to purchase Fairchild parts either directly from Fairchild or from Authorized Fairchild Distributors who are listed by country on our web page cited above. Products customers buy either from Fairchild directly or from Authorized Fairchild Distributors are genuine parts, have full traceability, meet Fairchild's quality standards for handling and storage and provide access to Fairchild's full range of up-to-date technical and product information. Fairchild and our Authorized Distributors will stand behind all warranties and will appropriately address any warranty issues that may arise. Fairchild will not provide any warranty coverage or other assistance for parts bought from Unauthorized Sources. Fairchild is committed to combat this global problem and encourage our customers to do their part in stopping this practice by buying direct or from authorized distributors.

PRODUCT STATUS DEFINITIONS

Definition of Terms

Datasheet Identification	Product Status	Definition
Advance Information	Formative / In Design	Datasheet contains the design specifications for product development. Specifications may change in any manner without notice.
Preliminary	First Production	Datasheet contains preliminary data; supplementary data will be published at a later date. Fairchild Semiconductor reserves the right to make changes at any time without notice to improve design.
No Identification Needed	Full Production	Datasheet contains final specifications. Fairchild Semiconductor reserves the right to make changes at any time without notice to improve the design.
Obsolete	Not In Production	Datasheet contains specifications on a product that is discontinued by Fairchild Semiconductor. The datasheet is for reference information only.

Rev. 138