

Kühlkörper für Transistoren im Plastikgehäuse

Heatsinks for transistors in plastic case

Dissipateurs pour transistors en boîtier plastique

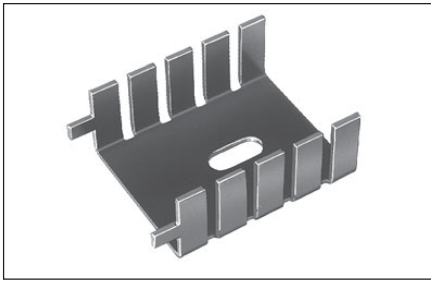

FK 222 ...

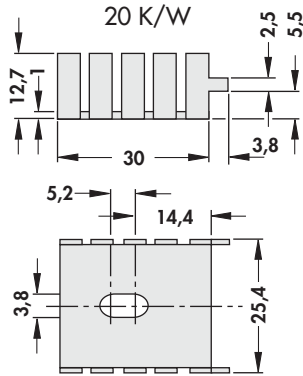

 TO 220

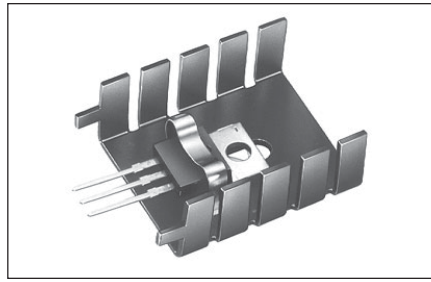

FK 222 THF ...

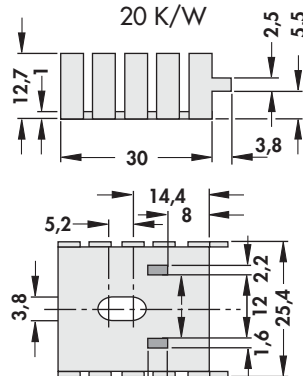

 TO 220

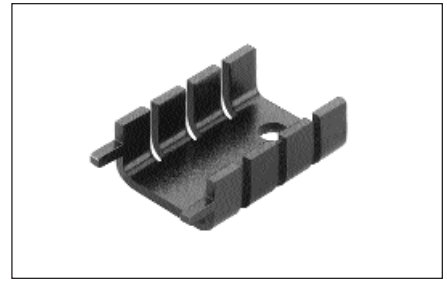

FK 247 220 ...

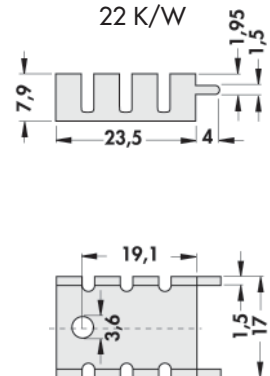

... bitte gewünschte Oberfläche angeben:
SA = schwarz eloxiert
MI = lötfähige Oberfläche

... please indicate requested surface:
SA = black anodised
MI = solderable surface

... prière d'indiquer la finition:
SA = anodisé noir
MI = surface soudable

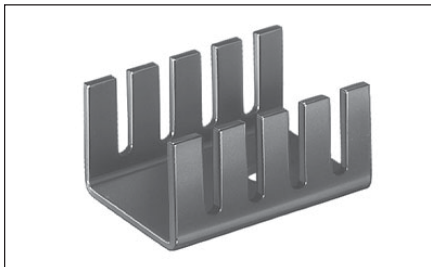

FK 231 SA 220

24 K/W

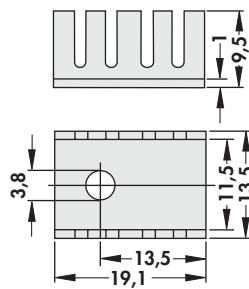

 TO 220

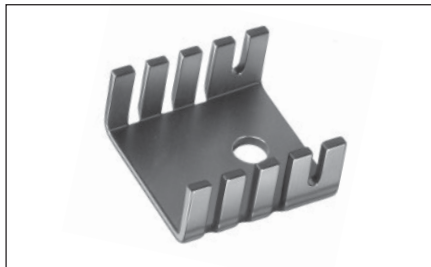

FK 239 SA 32

24 K/W

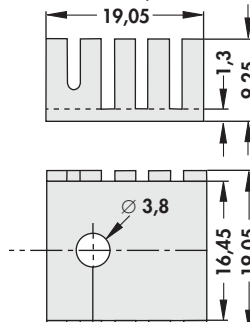

 SOT 32

Material: Aluminium
Oberfläche: schwarz eloxiert

Material: Aluminium
Surface: black anodised

Matière: Aluminium
Finition: anodisée noire