

# General Purpose Power Entry Module with Fuses



- Rated currents up to 10 A
- Integrated single/dual fuse holder
- Optional reduced leakage current versions (A/B type)
- Complies with IEC/EN 60601-1
- Snap-in versions (S type)
- Good attenuation performance



### Performance indicators

Attenuation performance



### Approvals & Compliances



The FN 9260 power entry module combines an IEC inlet, mains filter with excellent filter attenuation and fuses in a small form factor. Choosing FN 9260 product line brings you rapid availability of a standard filter associated with the necessary safety acceptances. Standard IEC connector filters are a practical solution helping you to pass EMI system approval in a short time. A wide selection on amperage ratings, output connections, mounting possibilities and filters for medical applications are designed to offer you the desired solution.

### Features and Benefits

- Exceptional conducted attenuation performance, based on chokes with high saturation resistance and excellent thermal behavior
- FN 9260 B versions comply with the requirements of 1MOP acc. to IEC/EN 60601-1 for creepage and clearance, leakage current and high potential testing
- Versions up to 10 A are available with fuse holder for one or two fuses
- Custom-specific versions are available on request

### Technical specifications

<b>Maximum continuous operating voltage</b>	250 VAC, 50/60 Hz
<b>Operating frequency</b>	DC to 400 Hz
<b>Rated currents</b>	1 to 10 A @ 40°C max.
<b>High potential test voltage</b>	P → PE 2000 VAC for 2 sec (standard types) P → PE 2500 VAC for 2 sec (B types) P → N 760 VAC for 2 sec (standard types) P → N 1700 VDC for 2 sec (B types)
<b>Protection category</b>	IP 40 according to IEC 60529
<b>Temperature range (operation and storage)</b>	-25°C to +85°C (25/85/21)
<b>Design corresponding to</b>	UL 60939-3, CSA Std C22.2 No. 8, IEC/EN 60939-3, GB/T 15287, GB/T15288
<b>Flammability corresponding to</b>	Inlet plastic: UL 94 V-0 Fuseholder plastic: UL 94 V-0
<b>MTBF @ 40°C/230 V (Mil-HB-217F)</b>	2,200,000 hours
<b>Fuse holder</b>	1 or 2 fuses (Ø5 x 20 mm) (certified to IEC 60127-6)
<b>Operating voltage</b>	250 VAC, 50/60 Hz

### Typical applications

- Portable electrical and electronic equipment
- Medical equipment
- Small to medium-sized machines and household equipment
- Single-phase power supplies, switch-mode power supplies
- Test and measurement equipment

### Typical electrical schematic



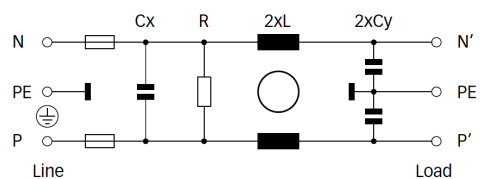



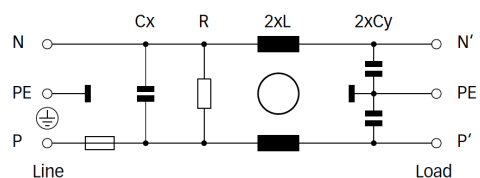









FN 9260 (B types without Y-capacitors)



FN 261



## Filter selection table

Filter	Buy	Rated current @ 40°C (25°C)	Leakage current* @ 250 VAC/50 Hz (@ 120 VAC/60 Hz)	Inductance** L	Capacitance**		Resistance** R	Input/Output connections	Fuses*** [Qty]	Weight [g]
					Cx	Cy				
		[A]	[mA]	[mH]	[μF]	[nF]	[kΩ]			
FN9260x-1-06-y		1 (1.2)	0.31 (0.18)	5.3	0.1	2.2	1000	-06	2	55
FN9260x-2-06-y		2 (2.3)	0.31 (0.18)	2.7	0.1	2.2	1000	-06	2	55
FN9260x-4-06-y		4 (4.6)	0.31 (0.18)	1.0	0.1	2.2	1000	-06	2	55
FN9260x-6-06-y		6 (6.9)	0.31 (0.18)	0.3	0.1	2.2	1000	-06	2	55
FN9260x-10-06-y		10 (11.5)	0.31 (0.18)	0.2	0.1	2.2	1000	-06	2	55
FN9260xA1-1-06-y		1 (1.2)	0.03 (0.02)	5.3	0.1	0.22	1000	-06	2	55
FN9260xA-2-06-y		2 (2.3)	0.07 (0.04)	2.7	0.1	0.47	1000	-06	2	55
FN9260xA-4-06-y		4 (4.6)	0.07 (0.04)	1.0	0.1	0.47	1000	-06	2	55
FN9260xA-6-06-y		6 (6.9)	0.07 (0.04)	0.3	0.1	0.47	1000	-06	2	55
FN9260xA-10-06-y		10 (11.5)	0.07 (0.04)	0.2	0.1	0.47	1000	-06	2	55
FN9260xB-1-06-y		1 (1.2)	0.00	5.3	0.1		1000	-06	2	55
FN9260xB-2-06-y		2 (2.3)	0.00	2.7	0.1		1000	-06	2	55
FN9260xB-4-06-y		4 (4.6)	0.00	1.0	0.1		1000	-06	2	55
FN9260xB-6-06-y		6 (6.9)	0.00	0.3	0.1		1000	-06	2	55
FN9260xB-10-06-y		10 (11.5)	0.00	0.2	0.1		1000	-06	2	55
FN261x-1-06-y		1 (1.2)	0.31 (0.18)	5.3	0.1	2.2	1000	-06	1	55
FN261x-2-06-y		2 (2.3)	0.31 (0.18)	2.7	0.1	2.2	1000	-06	1	55
FN261x-4-06-y		4 (4.6)	0.31 (0.18)	1.0	0.1	2.2	1000	-06	1	55
FN261x-6-06-y		6 (6.9)	0.31 (0.18)	0.3	0.1	2.2	1000	-06	1	55
FN261x-10-06-y		10 (11.5)	0.31 (0.18)	0.2	0.1	2.2	1000	-06	1	55

\* Leakage current under normal operating conditions (acc. to IEC60939-3). Note: if the neutral line is interrupted, worst case leakage could reach twice this level.



\*\* Tolerances apply: Inductance: -30/+50%, Capacitance: ±20%, Resistance: ±10%

\*\*\* Fuses are not included in the filter and need to be selected according to application

**Product selector**

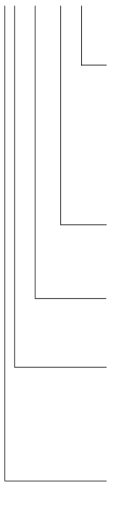
FN 9260xx-yy-yy-y



- Snap-in range for S version only
  - 10: Snap-in range 0.6 to 1.5mm
  - 20: Snap-in range 1.6 to 2.5mm
  - 30: Snap-in range 2.6 to 3.5mm
- 06: Faston 6.3 x 0.8mm (spade/soldering)
- 1 to 10: Rated current
- Blank: Standard version
- A: Safety version
- B: Medical version (without Y-capacitor)
-  Blank: Standard housing with mounting flanges
-  S: Snap-in version, snapper on vertical side

For example: FN 9260-1-06-10, FN 9260 SB-10-06-20, FN 261 S-6-06-30

### Typical filter attenuation

Per CISPR 17; A=50 Ω/50 Ω sym; B=50 Ω/50 Ω asym; C=0.1 Ω/100 Ω sym; D=100 Ω/0.1 Ω sym

FN 261/ FN 9260: 1 A type

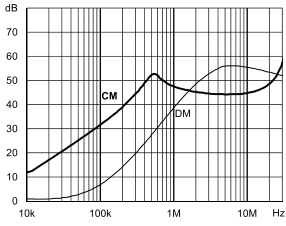

FN 261/ FN 9260: 2 A type

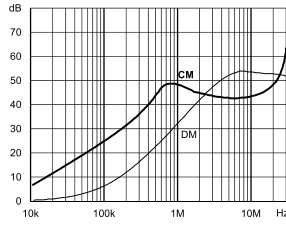

FN 261/ FN 9260: 4 A type

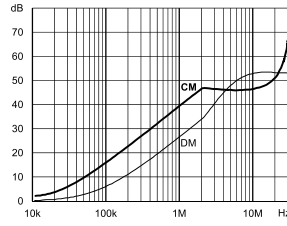

FN 261/ FN 9260: 6 and 10 A types

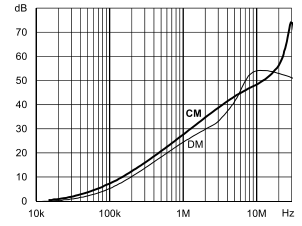

### Mechanical data

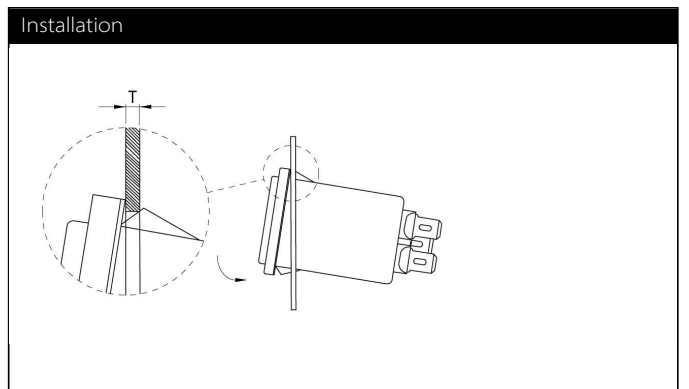
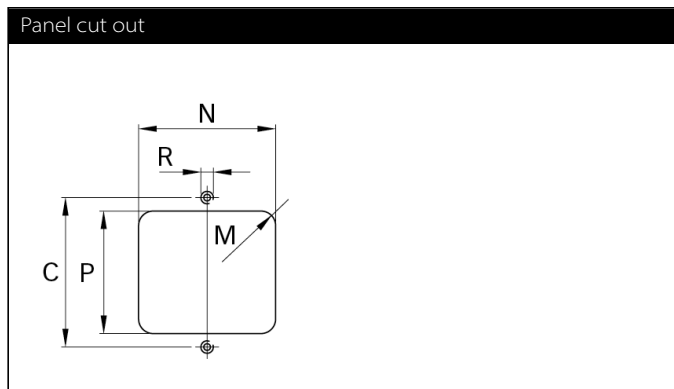
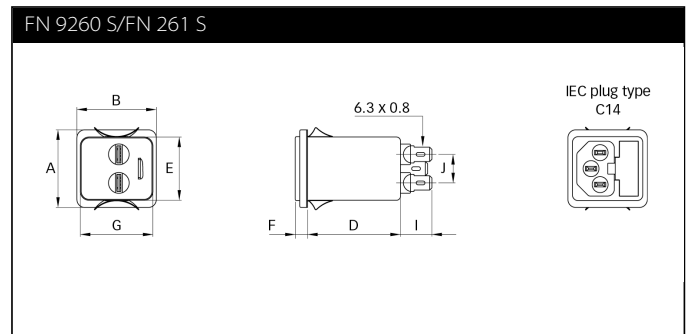
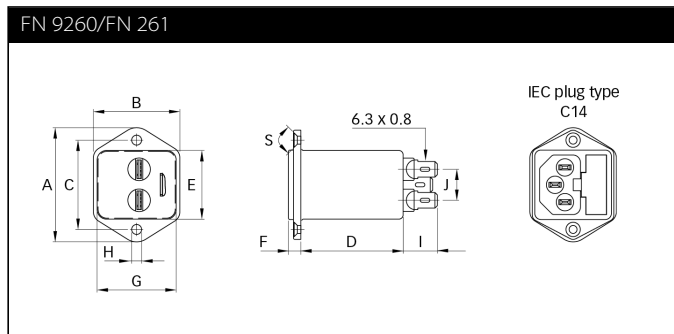

## Dimensions

	<b>FN 261</b> <b>FN 9260</b>	<b>FN 261 S</b> <b>FN 9260 S</b>	<b>Tolerances</b>
<b>A</b>	46	34	±0.3
<b>B</b>	35	35	±0.3
<b>C</b>	36		±0.3
<b>D</b>	41	41	±0.3
<b>E</b>	27.8	27.8	+0.3/-0
<b>F</b>	5.5	5.5	±0.3
<b>G</b>	32	32	+0.3/-0
<b>H</b>	Ø3.2		±0.1
<b>I</b>	14	14	±0.5
<b>J</b>	12.5	12.5	±0.3
<b>M</b>	R ≤3.5	R ≤3.5	
<b>N</b>	33	33	+0.3/-0
<b>P</b>	29	29.5	±0.3
<b>R*</b>	M3		
<b>S</b>	90°		
<b>T**</b>		0.6-1.5	
<b>T**</b>		1.6-2.5	
<b>T**</b>		2.6-3.5	

\* Recommended torque for M3 (90° countersunk flat head) is 0.5 Nm

\*\* For selecting the panel thickness, please refer to the filter selector table.

All dimensions in mm; 1 inch = 25.4 mm  
Tolerances according: ISO 2768-m/EN 22768-m

Please visit [www.schaffner.com](http://www.schaffner.com) to find more details on filter connections.

## Appropriated products

### Accessories for IEC Inlet Filters and Power Entry Modules

The accessories displayed are a selection of available accessories for IEC Inlet filters and IEC Power entry modules. As they are displayed in a general way there might be variants of the filters where the accessories are not available.

For further information please ask your local Schaffner Sales Partner and visit our homepage <https://www.schaffner.com/>.

#### Power Cord with Locking System for Inlet Filters IL 13, IL 13 P, IL 19



Link to Datasheet: [Datasheet IEC C13/C19 locking cable](#)

The locking system has a tensile force of typical 200N.

It is recommended to use it with flange mount filters.

Lock Power Cords with IEC Inlets and Filters"

Schaffner power cords with IEC lock guard against

accidental disconnection of all electrical appliances

with an IEC inlet. No exchange or modification of the

IEC inlet or IEC inlet filter system is needed. Easy

retrofit for all electronic equipments and devices.

#### IEC C13 Rewireable Connector for individual Power Cord with Locking System



Link to Datasheet: [Datasheet IEC C13 rewireable](#)

The locking system has a tensile force of typical 300N. It is recommended to

use it with flange mount filters. For details refer to our Application Note

"Using IEC Lock Power Cords with IEC Inlets and Filters" Schaffner power

connector with IEC lock guard against accidental disconnection of all

electrical appliances with an IEC inlet. No exchange or modification of the

IEC inlet or IEC inlet filter system is needed. Easy retrofit for all electronic

equipments and devices.

#### IB - Insulating Boots

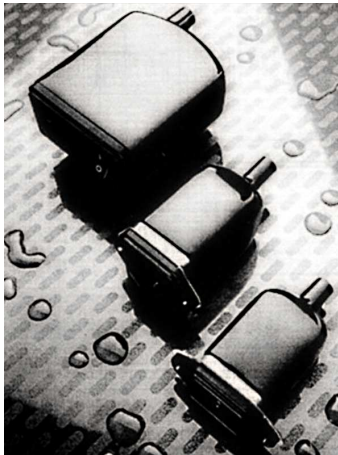

There is a full range of insulating boots available from Schaffner that provide a physical cover for the exposed terminals on the back of IEC Inlet Filters.

These boots fit the simplest non-fused and unswitched style up to the fully fused and switched IEC filtered inlet.

The boots are made from a durable black PVC material that conforms to UL94-V0 flammability requirements.

The boots slip easily over the back of the filter and reduce the risk of electrical shock to maintenance personnel whilst protecting the filter from environmental hazard such as the ingress of dust and moisture.



## Headquarters, global innovation and development

### Switzerland

#### Schaffner Group

Industrie Nord  
Nordstrasse 11e  
4542 Luterbach  
T +41 32 681 66 26  
[info@schaffner.com](mailto:info@schaffner.com)



## Sales and application centers

### China

#### Schaffner EMC Ltd. Shanghai

T20-3 C, No 565 Chuangye Road,  
Pudong district  
201201 Shanghai  
T +86 21 3813 9500  
[cschina@schaffner.com](mailto:cschina@schaffner.com)  
[www.schaffner.com.cn](http://www.schaffner.com.cn)

### Finland

#### Schaffner Oy

Sauvonrinne 19 H  
08500 Lohja  
T +358 10 567 2855  
[finlandsales@schaffner.com](mailto:finlandsales@schaffner.com)

### France

#### Schaffner EMC S.A.S.

16-20 Rue Louis Rameau  
95875 Bezons  
T +33 1 34 34 30 60  
F +33 1 39 47 02 28  
[francesales@schaffner.com](mailto:francesales@schaffner.com)

### Germany

#### Schaffner Deutschland GmbH

Schoemperlenstrasse 12B  
76185 Karlsruhe  
T +49 721 56910  
F +49 721 569110  
[germanysales@schaffner.com](mailto:germanysales@schaffner.com)

### India

#### Schaffner India Pvt. Ltd

REGUS WORLD TRADE CENTRE  
WTC, 22nd Floor Unit No 2238, Brigade  
Gateway Campus, 26/1, Dr. Rajkumar Road  
Malleshwaram (W)  
560055 Bangalore  
T +91 80 67935355  
[indiasales@schaffner.com](mailto:indiasales@schaffner.com)

### Italy

#### Schaffner EMC S.r.l.

Via Ticino, 30  
20900 Monza (MB)  
T +39 039 21 41 070  
[italysales@schaffner.com](mailto:italysales@schaffner.com)

### Japan

#### Schaffner EMC K.K.

Taiju-Seimei Sangenjaya Bldg.  
1-32-12, Kamiyama, Setagaya-ku  
154-0011 Tokyo  
T +81 3 5712 3650  
F +81 3 5712 3651  
[japansales@schaffner.com](mailto:japansales@schaffner.com)  
[www.schaffner.jp](http://www.schaffner.jp)

### Singapore

#### Schaffner EMC Pte Ltd.

#05-09, Kg Ubi Ind. Estate  
408705 Singapore  
T +65 6377 3283  
F +65 6377 3281  
[singaporesales@schaffner.com](mailto:singaporesales@schaffner.com)

### Spain

#### Schaffner EMC España

Calle Caléndula 93, Miniparc III, Edificio E  
El Soto de Moraleja, Alcobendas  
28109 Madrid  
T +34 917 912 900  
F +34 917 912 901  
[spainsales@schaffner.com](mailto:spainsales@schaffner.com)

### Sweden

#### Schaffner EMC AB

Östermalmstorg 1  
114 42 Stockholm  
T +46 8 5050 2425  
[swedensales@schaffner.com](mailto:swedensales@schaffner.com)  
[www.schaffner.com](http://www.schaffner.com)

### Switzerland

#### Schaffner EMV AG

Industrie Nord  
Nordstrasse 11e  
4542 Luterbach  
T +41 32 681 66 88  
T +41 32 681 66 26  
[switzerlandsales@schaffner.com](mailto:switzerlandsales@schaffner.com)

### Taiwan R.O.C.

#### Schaffner EMV Ltd.

20 Floor-2, No 97, Section 1, XinTai 5th Road  
22175 XiZhi District New Taipei City 22175  
T +886 2 2697 5500  
F +886 2 2697 5533  
[taiwansales@schaffner.com](mailto:taiwansales@schaffner.com)  
[www.schaffner.com.tw](http://www.schaffner.com.tw)

### Thailand

#### Schaffner EMC Co. Ltd.

Northern Region Industrial Estate  
67 Moo 4 Tambon Ban Klang  
Amphur Muangng P.O. Box 14  
51000 Lamphun  
T +66 53 58 11 04  
F +66 53 58 10 19  
[thailandsales@schaffner.com](mailto:thailandsales@schaffner.com)

### United Kingdom

#### Schaffner Ltd.

1, Oakmede Place  
Binfield  
RG42 4JF Berkshire  
T +44 118 9770070  
F +44 118 9792969  
[uksales@schaffner.com](mailto:uksales@schaffner.com)

### USA

#### Schaffner EMC Inc.

52 Mayfield Avenue  
Edison, New Jersey  
T +1 732 225 9533  
F +1 732 225 4789  
[usasales@schaffner.com](mailto:usasales@schaffner.com)  
[www.schaffnerusa.com](http://www.schaffnerusa.com)

#### Schaffner North America

6722 Thirlane Road  
24019 Roanoke, Virginia  
T +1 276 228 7943  
F +1 276 228 7953

#### Schaffner North America

823 Fairview Road  
24382 Wytheville, Virginia  
T +1 276 228 7943  
F +1 276 228 7258

To find your local partner within Schaffner's global network: [www.schaffner.com](http://www.schaffner.com)

© 2018 Schaffner Group

The content of this document has been carefully checked and understood. However, neither Schaffner nor its subsidiaries assume any liability whatsoever for any errors or inaccuracies of this document and the consequences thereof. Published specifications are subject to change without notice. Product suitability for any area of application must ultimately be determined by the customer. In all cases, products must never be operated outside their published specifications. Schaffner does not guarantee the availability of all published products. This disclaimer shall be governed by substantive Swiss law and resulting disputes shall be settled by the courts at the place of business of Schaffner Holding AG. Latest publications and a complete disclaimer can be downloaded from the Schaffner website. All trademarks recognized.

# Mouser Electronics

Authorized Distributor

Click to View Pricing, Inventory, Delivery & Lifecycle Information:

## Schaffner:

[FN9260S-4-06-20](#) [FN9260SB-4-06-10](#) [FN9260SB-6-06-20](#) [FN9260-6-06](#) [FN9260-4-06](#) [FN9260-1-06](#) [FN9260B-6-06](#) [FN9260B-4-06](#) [FN9260-2-06](#) [FN9260B-2-06](#) [FN9260-10-06](#) [FN9260A-2-06](#) [FN9260A-4-06](#) [FN9260A-6-06](#) [FN9260A-10-06](#) [FN9260A1-1-06](#) [FN9260B-1-06](#) [FN9260B-10-06](#) [FN9260S-1-06-10](#) [FN9260S-2-06-10](#) [FN9260S-4-06-10](#) [FN9260S-6-06-10](#) [FN9260S-10-06-10](#) [FN9260SB-1-06-30](#) [FN9260SB-2-06-10](#) [FN9260SB-2-06-30](#) [FN9260S-10-06-20](#) [FN9260SB-6-06-10](#) [FN9260SB-10-06-10](#)