

POWER RELAY

1 POLE - 6A Slim Type (Medium Load Control)

FTR-LY Series

■ FEATURES

- Slim 15.0mm (h) x 5.0 mm (w) x 28.0mm (l) (straight type)
5.0mm (h) x 15.0mm(w) x 28.0mm (l) (right angle type)
- 1 form C and 1 form A
- Straight and right angle type available
- Mounting space: 140mm² (straight type), weight: 5.0g
- High insulation in small package
Insulation distance (between coil and contacts): 8mm (creepage/clearance)
Dielectric strength: 4,000 VAC
Surge strength: 6,000V
- Plastic sealed type RTIII
- UL, CSA, VDE compliance
- Socket type available
- RoHS compliant
- Conforms to UL61010-1, UL61010-2-201, IEC/EN61010-1, IEC/EN61010-2-201 (max. 277VAC)
Please see page 7 for more information
- UL hazardous locations (ANSI/ISA12.12.01) compliant type is available

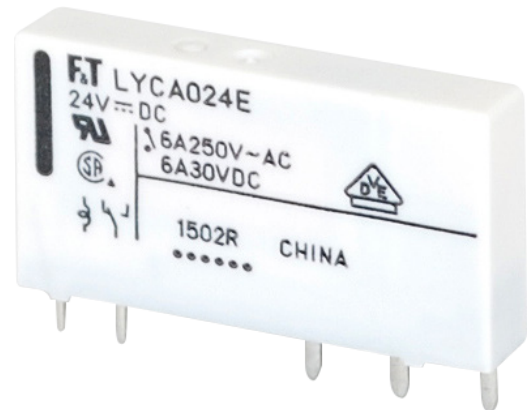

■ PARTNUMBER INFORMATION

[Example] FTR-LY A A 005 Y - SK
 (a) (b) (c) (d) (e) (f)

(a)	Relay type	FTR-LY : FTR-LY-Series
(b)	Contact configuration	A : 1 form A C : 1 form C P : 1 form A (right angle type) R : 1 form C (right angle type)
(c)	Coil type	A : Standard type (170mW)
(d)	Coil rated voltage	005 : 5.....60 VDC Coil rating table at page 3
(e)	Contact material	E : AgNi Y : AgSnO ₂ V : AgSnO ₂ + Au plating
(f)	Special type	Nil : PCB mounting type SK : Socket mounting type (only contact configuration A and C) HZ : UL hazardous locations compliant type*

Actual marking does not carry the type name : "FTR" and "SK"
 E.g.: Ordering code: FTR-LYAA005Y-SK Actual marking: LYAA005Y
 *UL hazardous locations compliant carries ▲ mark.

FTR-LY SERIES

■ SPECIFICATION

Item	LY (C,R) A () (Y,E,V)		LY (A,P) A () (Y,E,V)	
Contact Data	Configuration		1 form C (SPDT)	
	Construction		Single	
	Material		Y: AgSnO ₂ / E: AgNi / V: AgSnO ₂ + Au plating	
	Resistance (initial)		Y, E: Max. 100 mΩ at 6 VDC, 1 A V: Max. 30 mΩ at 6 VDC, 1A	
	Contact rating		6A, 250VAC / 24VDC (resistive)	
	Max. carrying current		6A	
	Max. switching voltage		250VAC	
	Max. switching power		1,500VA / 144W	
	Min. switching load *		Y, E: 100 mA 5 VDC V: 10mA 5 VDC	
Life	Mechanical		Min. 10 x 10 ⁶ operations	
	Electrical		Min. 50 x 10 ³ operations (N.O.) Min. 30 x 10 ³ operations (N.C.) at 6A, 250VAC / 24VDC resistive	
Coil Data	Rated power		170 to 217 mW	
	Operate power		74 to 95 mW	
	Operating temperature range		-40 °C to +85 °C (no frost)	
Timing Data	Operate (at nominal voltage)		Max. 8ms (no diode, without bounce)	
	Release (at nominal voltage)		Max. 4ms (no diode, without bounce)	
Insulation	Resistance (initial)		Min. 1,000MΩ at 500VDC	
	Dielectric strength	Open contacts	1,000VAC (50/60Hz) 1min., 10mA detection current	
		Contacts to coil	4,000VAC (50/60Hz) 1min., 10mA detection current	
	Surge strength	Coil to contacts	6,000V / 1.2 x 50μs standard wave	
	Clearance		Min. 8 mm	
	Creepage		Min. 8 mm	
	EN61810-1, VDE0435	Voltage	250V	
		Pollution degree	3	
		Material group	III a	
	Category	C / 250V		
Other	Vibration resistance	Misoperation	10 to 55 to 10Hz single amplitude 0.5mm	
		Endurance	10 to 55 to 10hz single amplitude 0.75mm	
	Shock	Misoperation	Min. 50m/s ² (11 ± 1ms)	Min. 100m/s ² (11 ± 1ms)
		Endurance	Min. 1,000m/s ² (6 ± 1ms)	
	Weight		Approximately 5 g	
	Sealing		Plastic sealed RTIII	

* Minimum switching loads mentioned above are reference values. Please perform the confirmation test with actual load before production since reference values may vary according to switching frequencies, environmental conditions and expected reliability levels.

■ COIL RATING

Coil Code	Rated Coil Voltage (VDC)	Coil Resistance +/- 10% (Ohm)	Must Operate Voltage (VDC) *	Must Release-Voltage (VDC) *	Rated Power (mW)
005	5	147	3.3	0.25	170
006	6	211	4	0.3	
009	9	476	5.9	0.45	
012	12	847	7.9	0.6	
018	18	1,910	11.9	0.9	
024	24	3,390	15.9	1.2	
048	48	10,600	31.7	2.4	217
060	60	20,570	39.6	3	175

* : Specified operate values are valid for pulse wave voltage

Note 1: All values given in the coil table(s) are valid at 20°C ambient temperature, at zero contact current, without pre-energizing and are specified at pulse wave voltage.

Note 2: When applying a higher than rated coil voltage, please refer to the "coil temperature rise" and "operating range" reference graphs, for the effects on the relay operating behaviour.

■ SAFETY STANDARDS

Type	Compliance	Contact rating
UL	UL 508, E63614	Flammability: UL 94-V0 (plastics)
	ANSI/ISA 12.12.01, E225300 (Applicable for -HZ)	6A, 277 VAC (resistive) 6A, 30 VDC (resistive) 1/10 hp, 277VAC/125VAC
CSA	C22.2 No. 14 LR 40304	1/8hp, 277VAC/125VAC Pilot duty: D300, C300, R300, B300
VDE	IEC/EN61810-1	6A 250VAC (cosφ=1), 6A 30VDC (0ms) 3 (1.5)A, 250VAC
	EN 60730-1 Clause 12.2, 13.2, 20.1, 20.2, 20.3, 17.5, 17.7, 17.8	
	EN 60335-1 Clause 15.3, 16.3, 29.1, 29.2, 29.3	

Also conform to UL61010-1, UL61010-2-201, IEC/EN61010-1, IEC/EN61010-2-201 (277VAC)

FTR-LY SERIES

CHARACTERISTIC DATA (For reference only)

(Characteristic data is not guaranteed value but measured values of samples from production line.)

Coil Temperature rise

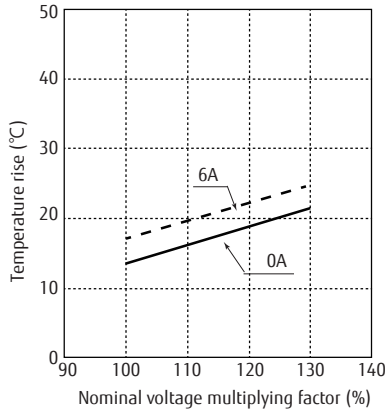

Operating range

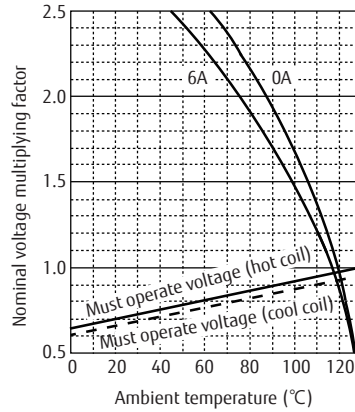

Maximum switching power

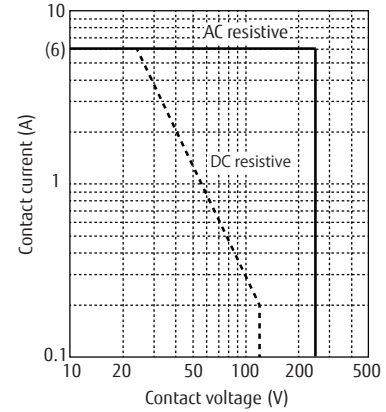

Life curve

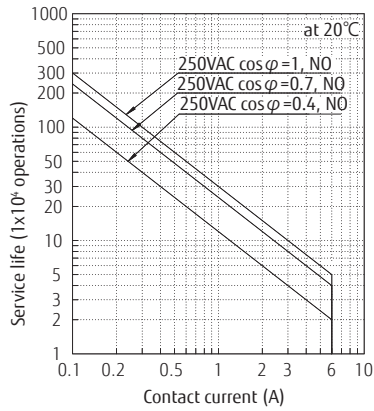

Life curve

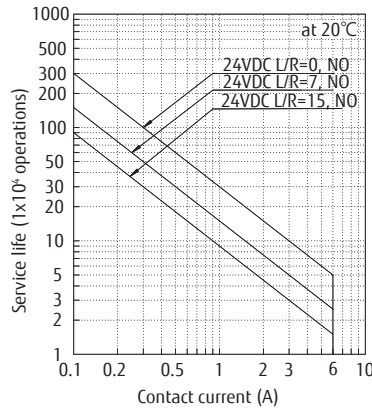

Distribution of operate/release voltage

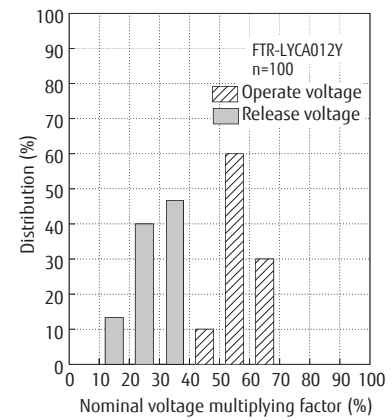

Distribution of contact resistance

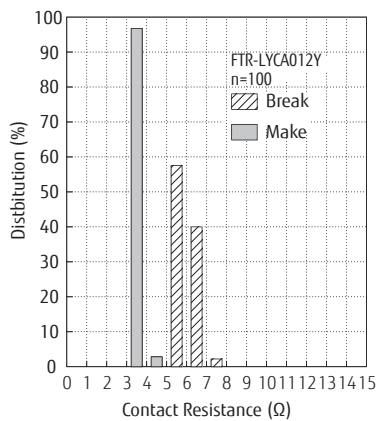

Distribution of operate/release time

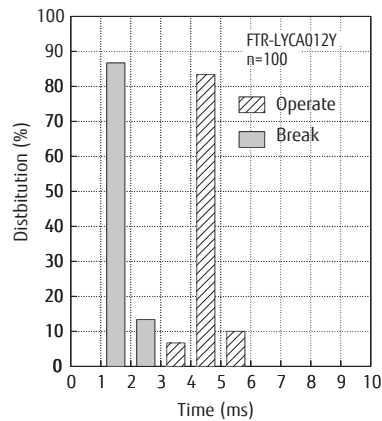

FTR-LY SERIES

■ DIMENSIONS

Straight type

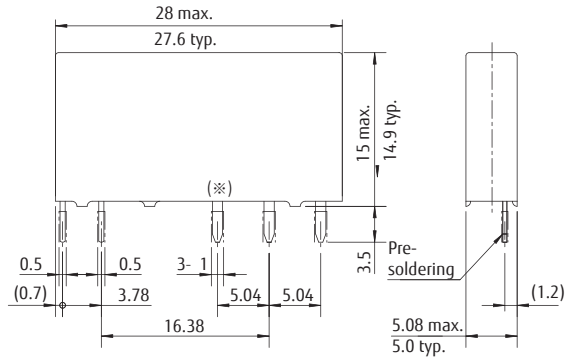

Schematics
(BOTTOM VIEW)

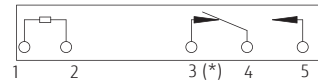

PCB Layout
(BOTTOM VIEW)

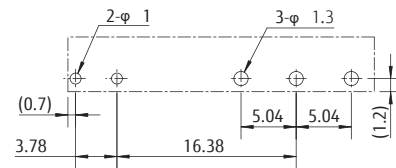

Tolerance: +/-0.1

Right angle type

Right angle type

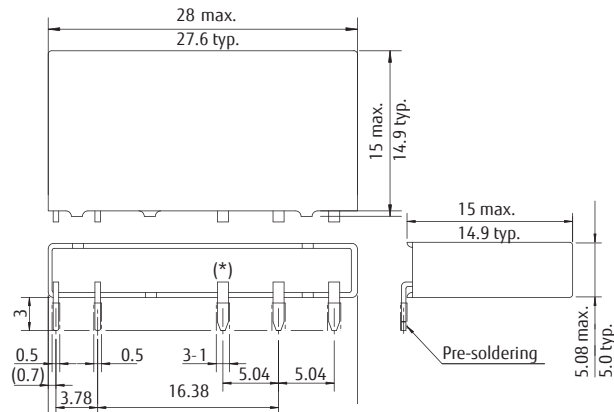

Schematics
(BOTTOM VIEW)

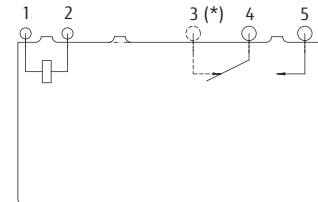

PCB Layout
(BOTTOM VIEW)

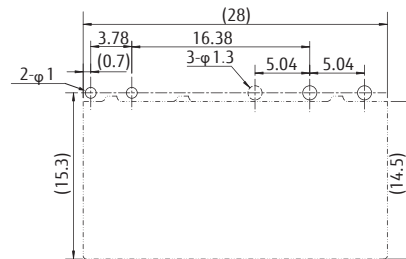

Tolerance: +/-0.1

- * The terminal marked (*) is not applicable for 1 form A type.
- * Dimensions of the terminals do not include thickness of pre-solder.

() : Reference value
Unit: mm

FTR-LY SERIES

Socket type

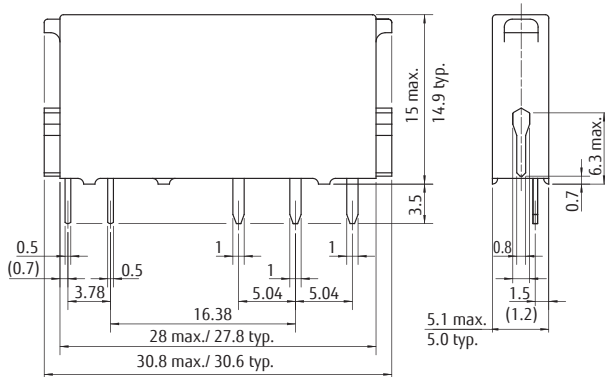

Schematics (BOTTOM VIEW)

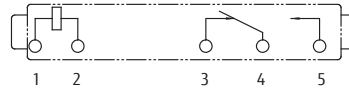

PCB layout (BOTTOM VIEW)

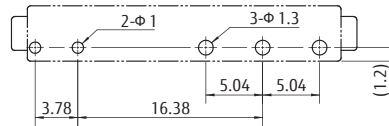

Tolerance: +/-0.1

JM-6N

Socket (JM-6N)

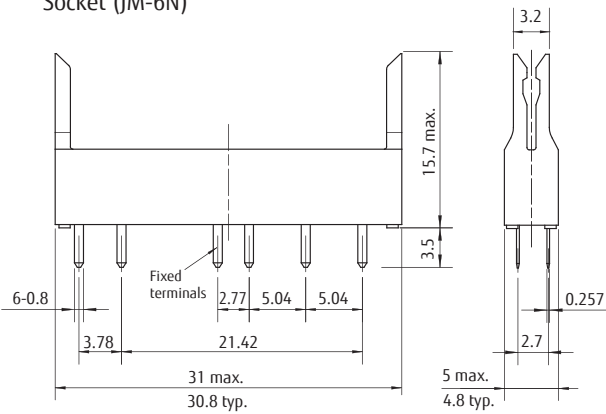

PCB layout (BOTTOM VIEW)

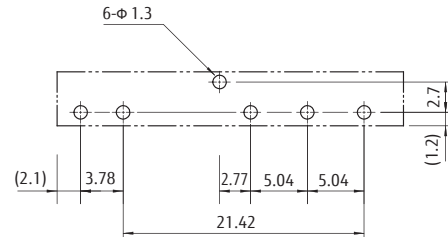

Tolerance: +/-0.1

* Dimensions of the terminals of JM-6N do not include thickness of pre-solder.

(): Reference value
Unit: mm

Note: Tolerance of PC board mounting hole layout : ±0.1 unless otherwise specified.
 Note: Dimensions of the terminals do not include thickness of pre-solder.
 Note: This datasheet provide only + tolerance for outer dimensions.
 Please ask for specification in case you need other tolerances.

Cautions

- All values mentioned in this datasheet are provided under ideal conditions. Please perform the confirmation test before actual use.
- Reflow soldering is prohibited.
- Do not use relays in the atmosphere with sulfide gas, chloride gas or nitric oxide. Contact resistance may increase.
- Do not use silicon or silicon-containing product or materials near relays. It may cause contact failure.

RoHS Compliance and Lead Free Information

1. General Information

- All relays produced by Fujitsu Components are compliant with RoHS directive 2011/65/EU including amendments.
- Cadmium as used in electrical contacts is exempted from the RoHS directives. As per Annex III of directive 2011/65/EU.
- All relays are lead-free. Please refer to Lead-Free Status Info for older date codes at: <http://www.fujitsu.com/downloads/MICRO/fcai/relays/lead-free-letter.pdf>
- Lead free solder plating on relay terminals is Sn-3.0Ag-0.5Cu, unless otherwise specified. This material has been verified to be compatible with PbSn assembly process.

2. Recommended Lead Free Solder Condition

- Recommended solder Sn-3.0Ag-0.5Cu.

Flow Solder Condition:

Pre-heating: maximum 120°C within 90 sec

Soldering: dip within 5 sec. at 255°C ± 5°C solder bath

Relay must be cooled by air immediately after soldering

Solder by Soldering Iron:

Soldering Iron: 30-60W

Temperature: maximum 350-360°C

Duration: maximum 3 sec.

We highly recommend that you confirm your actual solder conditions

3. Moisture Sensitivity

- Moisture Sensitivity Level standard is not applicable to electromechanical relays, unless otherwise indicated.

4. Tin Whiskers

- Dipped SnAgCu solder is known as presenting a low risk to tin whisker development. No considerable length whisker was found by our in house test.

Fujitsu Components International Headquarter Offices

<p>Japan FUJITSU COMPONENT LIMITED Shinagawa Seaside Park Tower 20F, 12-4, Higashi-shinagawa 4-chome, Shinagawa-ku, Tokyo, 140-0002, Japan Tel: (81-3) 3450-1682 Fax: (81-3) 3474-2385 Email: fcl-contact@cs.jp.fujitsu.com Web: www.fcl.fujitsu.com/</p>	<p>Asia Pacific FUJITSU COMPONENTS ASIA, LTD. 102E Pasir Panjang Road #01-01 Citilink Warehouse Complex Singapore 118529 Tel: (65) 6375-8560 Fax: (65) 6273-3021 Email: fcal@sg.fujitsu.com Web: www.fujitsu.com/sg/products/devices/components</p>	<p>Korea FUJITSU COMPONENTS KOREA LIMITED Alpha Tower #403, 645 Sampyeong-dong, Bundang-gu, Seongnam-si, Gyeonggi-do, 13524 Korea Tel: (82) 31-708-7108 Fax: (82) 31-709-7108 Email: fcal@sg.fujitsu.com www.fujitsu.com/sg/products/devices/components/</p>
<p>North and South America FUJITSU COMPONENTS AMERICA, INC 2290 North First Street, Suite 212 San Jose, CA 95131, USA Tel: (1-408) 745-4900 Fax: (1-408) 745-4970 Email: components@us.fujitsu.com Web: us.fujitsu.com/components</p>	<p>China FUJITSU ELECTRONIC COMPONENTS (SHANGHAI) CO., LTD. Unit 4306, InterContinental Center 100 Yu Tong Road, Shanghai 200070, China Tel: (86-21) 3253 0998 Fax: (86-21) 3253 0997 Email: fcal@sg.fujitsu.com Web: www.fujitsu.com/sg/products/devices/components</p>	
<p>Europe FUJITSU COMPONENTS EUROPE B.V. Diamantlaan 25 2132 WV Hoofddorp Netherlands Tel: (31-23) 5560910 Fax: (31-23) 5560950 Email: info@fceu.fujitsu.com Web: www.fujitsu.com/uk/components</p>	<p>Hong Kong FUJITSU COMPONENTS HONG KONG CO., LTD Unit 2313, Seapower Tower, Concordia Plaza, No.1 Science Museum Road, TST, Kowloon, Hong Kong Tel: (852) 2881-8495 Tex: (852) 2894-9512 Email: fcal@sg.fujitsu.com Web: www.fujitsu.com/sg/products/devices/components/</p>	

©2021 Fujitsu Components Europe B.V. All rights reserved. All trademarks or registered trademarks are the property of their respective owners.

The contents, data and information in this datasheet are provided by Fujitsu Component Ltd. as a service only to its user and only for general information purposes.

The use of the contents, data and information provided in this datasheet is at the users' own risk.

Fujitsu has assembled this datasheet with care and will endeavor to keep the contents, data and information correct, accurate, comprehensive, complete and up to date.

Fujitsu Components Europe B.V. and affiliated companies do however not accept any responsibility or liability on their behalf, nor on behalf of its employees, for any loss or damage, direct, indirect or consequential, with respect to this datasheet, its contents, data, and information and related graphics and the correctness, reliability, accuracy, comprehensiveness, usefulness, availability and completeness thereof.

Nor do Fujitsu Components Europe B.V. and affiliated companies accept on their behalf, nor on behalf of its employees, any responsibility or liability for any representation or warrant of any kind, express or implied, including warranties of any kind for merchantability or fitness for particular use, with respect to these datasheets, its contents, data, information and related graphics and the correctness, reliability, accuracy, comprehensiveness, usefulness, availability and completeness thereof. Rev. June 21st, 2021