

ROHS Compliant



台灣駿品端子股份有限公司

TAIWAN KING PIN TERMINAL CO.,LTD

台北縣樹林市俊德街 23 號

TEL:886-2-26895596.26886112 FAX:886-2-26886110

E-mail:tkp01.a88@msa.hinet.net http://www.tkp.com.tw

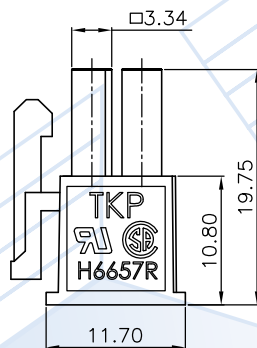
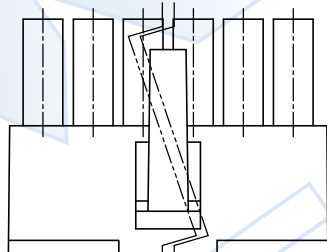
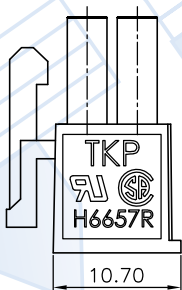
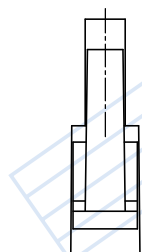
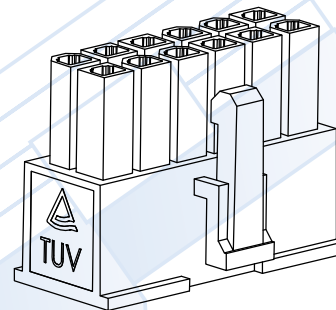
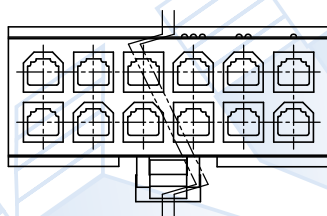
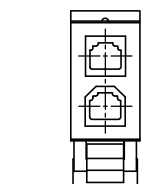

NOTE
 * Material : Nylon UL 94V-2 or UL 94V-0
 * Color : Natural / Black
 * Electrical rating : UL 250V 5A , AC/DC
 CSA 250V 4A , AC/DC
 TUV 250V 7A AC / DC
 * Accepts 6657TP(LF) terminal .
 * Mates with H6657P series plug housings
 or P6657I , P6657L series headers
 * Dual row , 2-24 circuits available

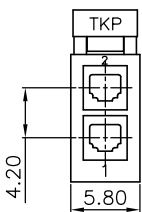

H6657R1-02

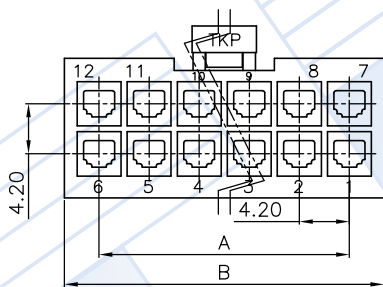

Circuits	Part No.	Dim.A	Dim.B	Circuits	Part No.	Dim.A	Dim.B
2	H6657R1-02	—	5.80	14	H6657R1-14	25.20	31.00
4	H6657R1-04	4.20	10.00	16	H6657R1-16	29.40	35.20
6	H6657R1-06	8.40	14.20	18	H6657R1-18	33.60	39.40
8	H6657R1-08	12.60	18.40	20	H6657R1-20	37.80	43.60
10	H6657R1-10	16.80	22.60	22	H6657R1-22	42.00	47.80
12	H6657R1-12	21.00	26.80	24	H6657R1-24	46.20	52.00



PART NO.	H6657R1-XX			Part NO.	Material	Color	Remark	APPROVAL
TITLE	4.20mm Wire to Wire			H6657R1-XX	Nylon UL 94V-2	Natural		DRAWN: 詹雅茹
				H6657R1-XX/B	Nylon UL 94V-2	Black		CHECKED: 詹雅茹
				H6657R1-XX-V0	Nylon UL 94V-0	White		
				H6657R1-XX/BL-V0	Nylon UL 94V-0	Blue		
THIRD ANGLE	SCALE	UNIT	SHEET NO	TOLERANCE	DATE	ODD NUMBERS	REV	APPROVED: 陳泓宇
	1.25:1	mm	1/1	.X± 0.30 .XXX±0.10 .XX± 0.20 ANGLE±2°	2010.01.21	ENG950493	A2	
	420-011		C420-001					