

VISIBLE LIGHT PRODUCTS SPECIFICATION

HCL-1703AGC-4



Drawn by	Checked by	Approved by



DATE:2012/12/27

REV:K



HUEY JANN ELECTRONICS INDUSTRY CO., LTD.

No.27 Line 466 Sec.2,Cannng-nan Rd. Wu-chi Town Taichung Shien, Taiwan, R.O.C.

TEL:+886-4-26393976 FAX:+886-4-26393125

DEVICES

Part Number	Lens		Source	
	Color	Diffusion	Dice Source	Color
HCL-1703AGC-4	Water clear	Non-Diffused	GaN/GaN	Super Pure Green

PACKAGE DIMENSIONS

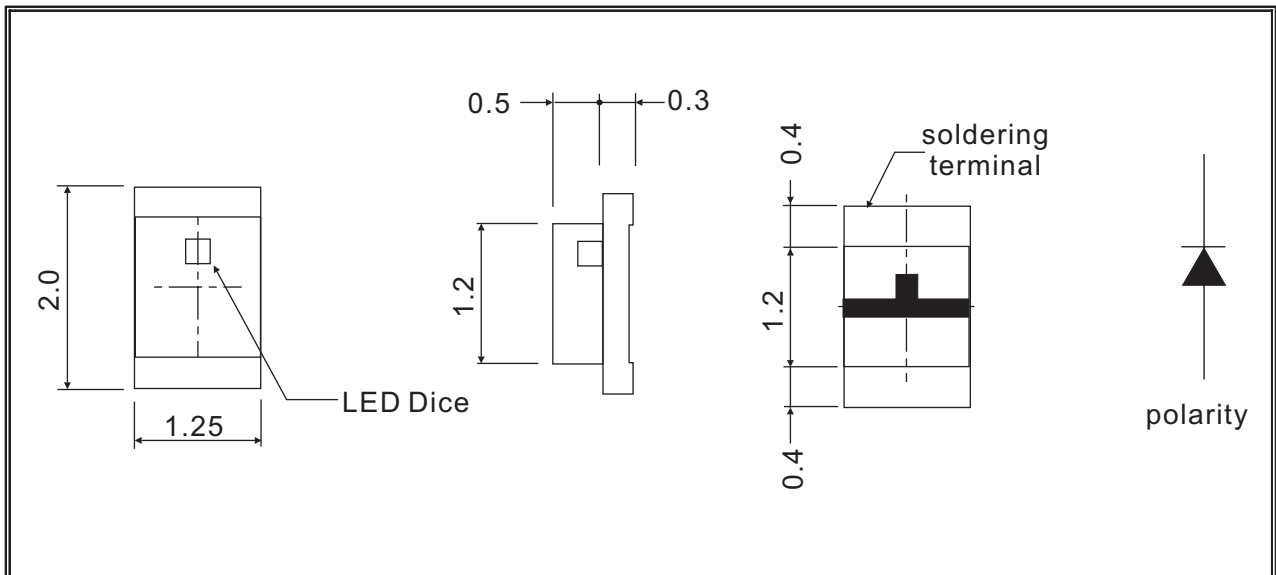

NOTE:

- 1.All dimensions are in millimeter.
- 2.specifications are subject to change without notice.
- 3.Tolerance is +/-0.3mm unless otherwise noted.



HUEY JANN ELECTRONICS INDUSTRY CO., LTD.

No.27 Line 466 Sec.2,Cannng-nan Rd. Wu-chi Town Taichung Shien, Taiwan, R.O.C.

TEL:+886-4-26393976 FAX:+886-4-26393125

RECOMMENDED SOLDERING PATTERN

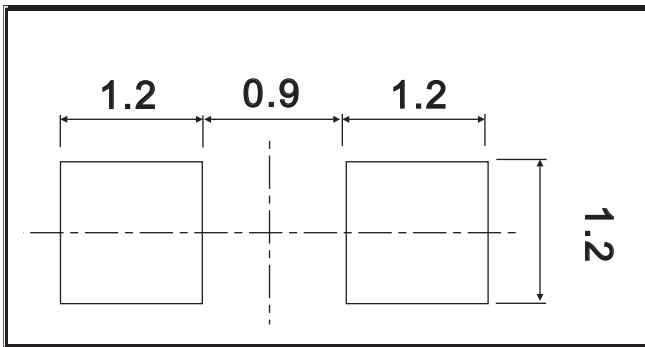

NOTE:

- 1.All dimensions are in millimeter.
- 2.specifications are subject to change without notice.

TAPE SPECIFICATIONS

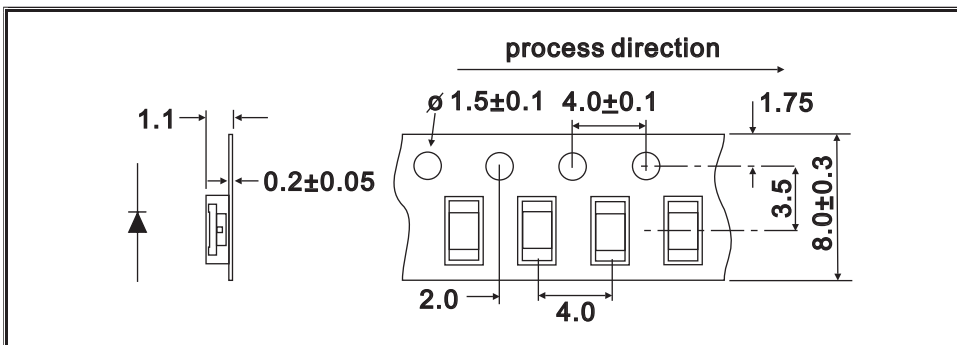

NOTE:

- 1.All dimensions are in millimeter.
- 2.specifications are subject to change without notice.



HUEY JANN ELECTRONICS INDUSTRY CO., LTD.

No.27 Line 466 Sec.2,Cannng-nan Rd. Wu-chi Town Taichung Shien, Taiwan, R.O.C.

TEL:+886-4-26393976 FAX:+886-4-26393125

ABSOLUTE MAXIMUM RATINGS

TA=25°C

PARAMETER	SYMBOL	MAX. RATING	UNIT
Power Dissipation	Pd	120	mW
Continuous Forward Current	IF	20	mA
Peak Forward Current *1	IFM	100	mA
Reverse Voltage	VR	5	V
Electrostatic Discharge (HBM)	ESD	150	V
Operating Temperature	Topr	-40 ~ +85	°C
Storage Temperature	Tstg	-40 ~ +85	°C
Reflow Soldering (preheat 150-180°C 60-120sec, soldering temp 260°C 10sec)			

*1.Duty Ratio=0.1%,Pulse Width=10us.

*2.Iron soldering in 350°C within 5 seconds will not cause damage to the dice. But be aware of the high temperature will not only make the epoxy soften but also cause the lead moving and the gold wire broken and even open. So before returning to the normal temperature PLEASE AVOID any serious pressure on the top of epoxy and lead.



HUEY JANN ELECTRONICS INDUSTRY CO., LTD.

No.27 Line 466 Sec.2,Cannng-nan Rd. Wu-chi Town Taichung Shien, Taiwan, R.O.C.

TEL:+886-4-26393976 FAX:+886-4-26393125

ELECTRIC-OPTICAL CHARACTERISTICS

TA=25°C

PARAMETER	SYMBOL	TEST CONDITION	MIN	TYP	MAX	UNIT
View Angle of Half Power	2θ1/2	IF=20mA		140		deg
Forward Voltage	VF			3.2	3.6	V
Reverse Current	IR	VR=5V			10	μA
Luminous Intensity *2	IV	IF=20mA	260	520		mcd
Peak Emission Wavelength	λp			523		nm
Dominate Wave Length *3	λd(HUE)			525		nm
Spectrum Width Of Half Valve	Δλ			45		nm

*2.Tolerance: +/-15% HUEY-JANN measuring equipment : EXELTRON 2001. 2.S370 made by U.D.T.

*3.The dominate wavelength , λ d, is derived from the CIE Chromaticity Diagram and represents the color of the device.



HUEY JANN ELECTRONICS INDUSTRY CO., LTD.

No.27 Line 466 Sec.2,Cannng-nan Rd. Wu-chi Town Taichung Shien, Taiwan, R.O.C.

TEL:+886-4-26393976 FAX:+886-4-26393125

RELIABILITY TEST

Classification	Test Item	Reference Standard	Test Conditions	Result
Endurance Test	Operation Life	MIL-STD-750:1026 MIL-STD-883:1005 JIS-C-7021 :B-1	Connect with a power if=20mA Ta=Under room temperature Test Time=1,000hrs	0/22
	High Temperature High Humidity Storage	MIL-STD-202:103B JIS-C-7021 :B-11	Ta=+85°C +/-5°C RH=90% ~ 95% Test Time=1,000hrs	0/22
	High Temperature Storage	MIL-STD-883:1008 JIS-C-7021 :B-10	High Ta=+85°C +/-5°C Test Time=1,000hrs	0/22
	Low Temperature Storage	JIS-C-7021 :B-12	Low Ta=-40°C +/-5°C Test Time=1,000hrs	0/22
	Environmental Test	Temperature Cycling	MIL-STD-202:107D MIL-STD-750:1051 MIL-STD-883:1010 JIS-C-7021 :A-4	-40°C ~ +25°C ~ +85°C ~ +25°C 60min 20min 60min 20min Test Time=200cycle
Thermal Shock		MIL-STD-202:107D MIL-STD-750:1051 MIL-STD-883:1010	-40°C +/-5°C ~ +85°C +/-5°C 20min 20min Test Time=200cycle	0/22

*Failure Criteria:

1. VF arise \geq 10%
2. IV decline \geq 30%
3. A failure is an LED that is open or shorted



HUEY JANN ELECTRONICS INDUSTRY CO., LTD.

No.27 Line 466 Sec.2,Cannng-nan Rd. Wu-chi Town Taichung Shien, Taiwan, R.O.C.

TEL:+886-4-26393976 FAX:+886-4-26393125

TYPICAL ELECTRICAL OPTICAL CHARACTERISTICS CURVES

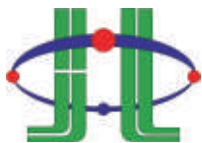
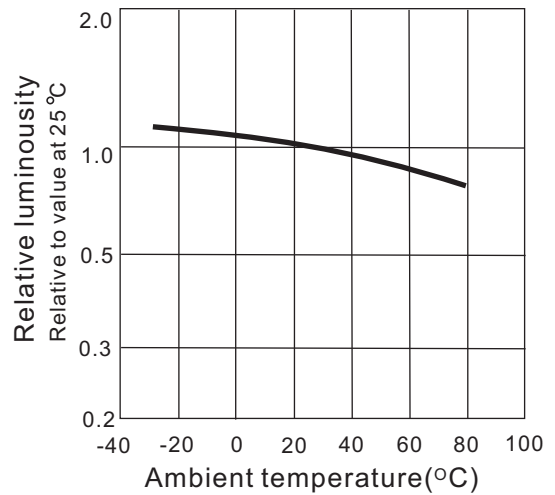
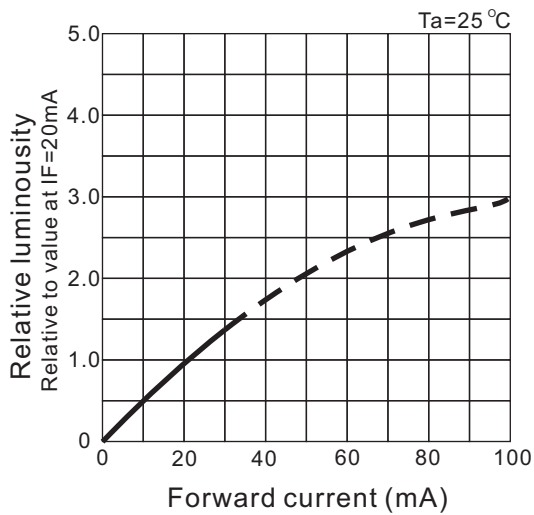
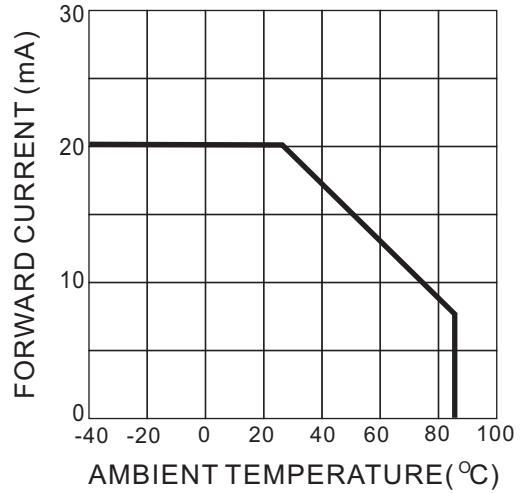
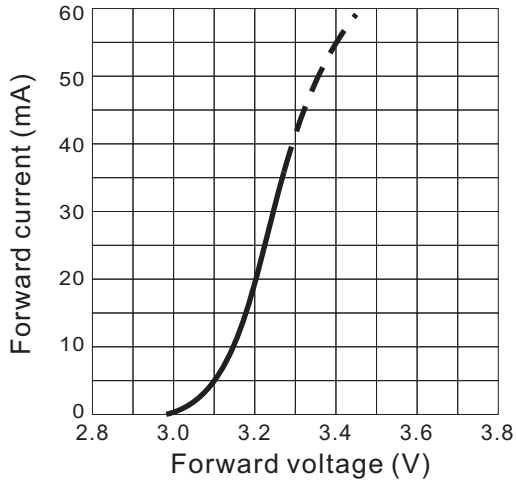

HUEY JANN ELECTRONICS INDUSTRY CO., LTD.

No.27 Line 466 Sec.2,Cannng-nan Rd. Wu-chi Town Taichung Shien, Taiwan, R.O.C.

TEL:+886-4-26393976 FAX:+886-4-26393125

TYPICAL ELECTRICAL OPTICAL CHARACTERISTICS CURVES

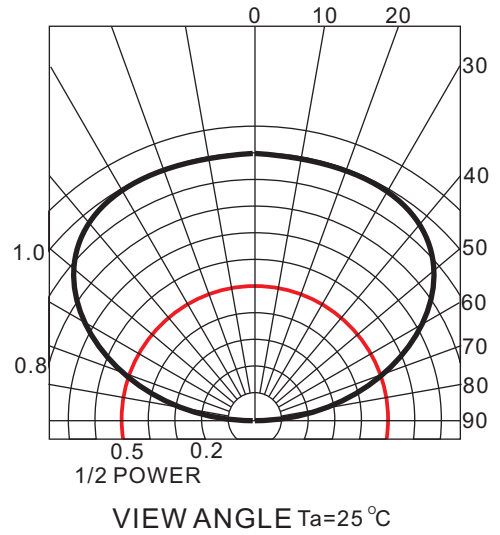
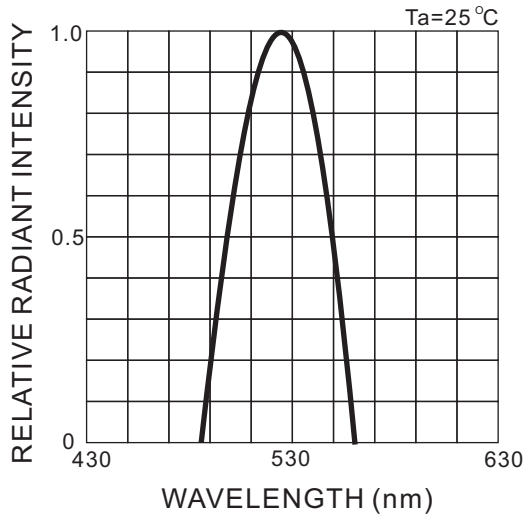

HUEY JANN ELECTRONICS INDUSTRY CO., LTD.

No.27 Line 466 Sec.2,Canng-nan Rd. Wu-chi Town Taichung Shien, Taiwan, R.O.C.

TEL:+886-4-26393976 FAX:+886-4-26393125

LED VF Bin Selection

$I_F=20\text{mA}$

BIN CODE	Forward Voltage	
	Minimum	Maximum
j	3.0	3.2
k	3.2	3.4
m	3.4	3.6

Voltage tolerance for each bin limit is +/-0.03V

Brightness Bin Selection

$I_F=20\text{mA}$

BIN CODE	Brightness in mcd	
	Minimum	Maximum
L	400	520
M	520	680

Brightness tolerance for each bin limit is +/-15%



HUEY JANN ELECTRONICS INDUSTRY CO., LTD.

No.27 Line 466 Sec.2,Cannng-nan Rd. Wu-chi Town Taichung Shien, Taiwan, R.O.C.

TEL:+886-4-26393976 FAX:+886-4-26393125

Color Bin Selection

$I_F=20\text{mA}$

Bin Code	Dominate Wavelength	
	Minimum	Maximum
3	521.0	524.0
4	524.0	527.0
5	527.0	530.0

Color tolerance for each bin limit is +/-0.5nm



HUEY JANN ELECTRONICS INDUSTRY CO., LTD.

No.27 Line 466 Sec.2,Cannng-nan Rd. Wu-chi Town Taichung Shien, Taiwan, R.O.C.

TEL:+886-4-26393976 FAX:+886-4-26393125

Precautions For Use

1. Over-current-proof

Customer must apply resistors for protection , otherwise slight voltage shift will cause big current change (Burn out will happen).

2. Storage

2.1 Do not open moisture proof bag before the products are ready to use.

2.2 Before opening the package, the LEDs should be kept at 30°C or less and 90%RH or less.

2.3 The LEDs should be used within a year.

2.4 After opening the package, the LEDs should be kept at 30°C or less and 60%RH or less.

2.5 The LEDs should be used within 168 hours (7 days) after opening the package.

2.6 If the moisture absorbent material (silica gel) has faded away or the LEDs have exceeded the storage time, baking treatment should be performed using the following conditions. Baking treatment : 60+/-5°C for 24 hours.

3. Soldering Condition

3.1 Pb-free solder temperature profile

Preheat:150 ~ 180°C

60 ~ 120seconds

Solder temp:260°C max

Time:10seconds max

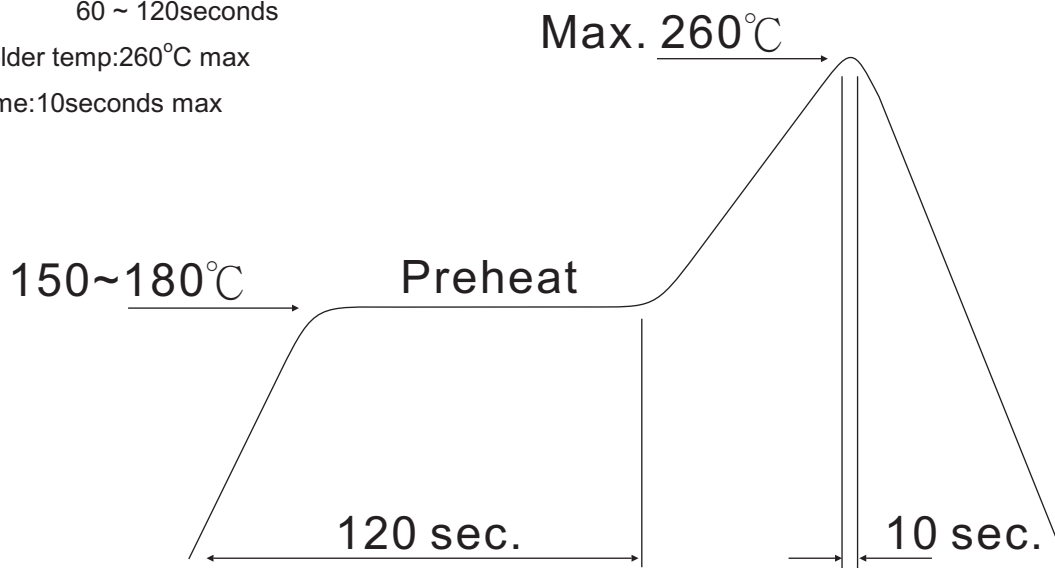

3.2 Reflow soldering should not be done more than two times.

3.3 When soldering, do not put stress on the LEDs during heating.

3.4 After soldering, do not warp the circuit board.



HUEY JANN ELECTRONICS INDUSTRY CO., LTD.

No.27 Line 466 Sec.2,Canng-nan Rd. Wu-chi Town Taichung Shien, Taiwan, R.O.C.
 TEL:+886-4-26393976 FAX:+886-4-26393125