

Agilent HLMP-3301 T-1³/₄ (5 mm) Diffused LED Lamps Data Sheet

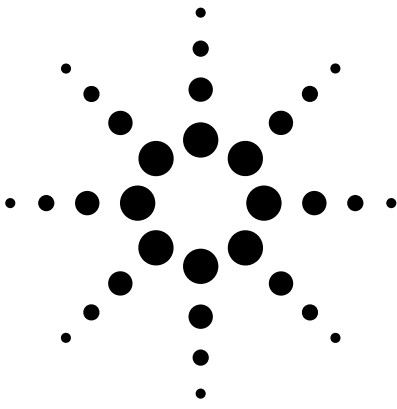

**HLMP-3301, HLMP-3401, HLMP-3507, HLMP-3762,
HLMP-3862, HLMP-3962, HLMP-D401**

Description

This family of T-1³/₄ tinted, diffused LED lamps is widely used in general purpose indicator applications. Diffusants, tints, and optical design

are balanced to yield superior light output and wide viewing angles. Several intensity choices are available in each color for increased design flexibility.

Features

- High intensity
- Choice of 4 bright colors
High Efficiency Red
Orange
Yellow
High Performance Green
- Popular T-1³/₄ diameter package
- Selected minimum intensities
- Wide viewing angle
- General purpose leads
- Reliable and rugged
- Available on tape and reel

Selection Guide

Material/ Color	Part Number	Luminous Intensity I _v (mcd) at 10 mA	
		Min.	Max.
GaP HER	HLMP-3301	5.4	–
	HLMP-3301-D00xx	2.1	–
	HLMP-3301-F00xx	5.4	–
	HLMP-3301-FG0xx	5.4	17.2
	HLMP-3762	8.6	–
	HLMP-3762-G00xx	8.6	–
GaP Yellow	HLMP-3401	5.7	–
	HLMP-3401-E00xx	5.7	–
	HLMP-3401-EF0xx	5.7	18.4
	HLMP-3401-EFBxx	5.7	18.4
	HLMP-3862	9.2	–
	HLMP-3862-F00xx	9.2	–
GaP Orange	HLMP-3862-FGBxx	9.2	29.4
	HLMP-D401	5.4	–
	HLMP-D401-D00xx	2.1	–
	HLMP-D401-EF0xx	3.4	10.8
GaP Green	HLMP-D401-F00xx	5.4	–
	HLMP-3507	4.2	–
	HLMP-3507-D00xx	4.2	–
	HLMP-3507-EF0xx	6.7	21.2
	HLMP-3962	10.6	–
	HLMP-3962-F00xx	10.6	–



Part Numbering System

HLMP - X X XX - X X X XX

Mechanical Option

- 00: Bulk
- 01: Tape & Reel, Crimped Leads
- 02: Tape & Reel, Straight Leads
- B1: Right Angle Housing, Uneven Leads
- B2: Right Angle Housing, Even Leads
- DD: Ammo Pack
- R4: Tape & Reel, Counter Clockwise

Color Bin Options

- 0: Full Color Bin Distribution
- B: Color Bins 2 & 3 only

Maximum Iv Bin Options

- 0: Open (no max. limit)
- Others: Please refer to the Iv Bin Table

Minimum Iv Bin Options

- Please refer to the Iv Bin Table

Brightness Level

- 0x: Less Brightness
- 62: Higher Brightness

Color Options

- 3,7: GaP HER
- 4,8: GaP Yellow (except D4xx)
- 5,9: GaP Green

Package Options

- 3: T-1 3/4 (5 mm)
- D: T-1 3/4 (5 mm) GaP Orange

Package Dimensions

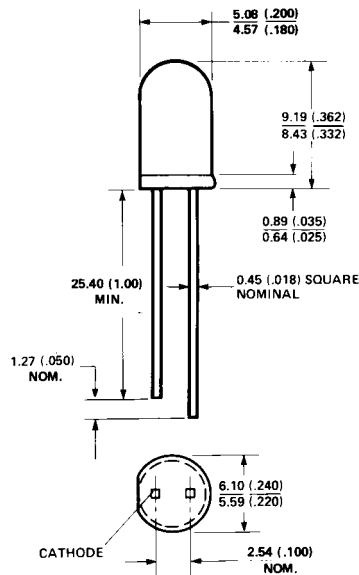

- NOTES:
 1. ALL DIMENSIONS ARE IN MILLIMETRES (INCHES).
 2. AN EPOXY MENISCUS MAY EXTEND ABOUT 1mm (.040") DOWN THE LEADS.

Optical/Electrical Characteristics at $T_A = 25^\circ\text{C}$

Symbol	Parameter	Color	Min.	Typ.	Max.	Units	Test Condition
$2\theta^{1/2}$	Included Angle Between Half Luminous Intensity Points	High Efficiency Red		60		Deg.	$I_F = 10\text{ mA}$ See Note 1
		Orange		60			
		Yellow		60			
		Green		60			
λ_{PEAK}	Peak Wavelength	High Efficiency Red		635		nm	Measurement at Peak
		Orange		600			
		Yellow		583			
		Green		565			
$\Delta\lambda_{1/2}$	Spectral Line Halfwidth	HER/Orange		40		nm	
		Yellow		36			
		Green		28			
λ_d	Dominant Wavelength	High Efficiency Red		626		nm	See Note 2
		Orange		602			
		Yellow		585			
		Green		569			
τ_s	Speed of Response	High Efficiency Red		90		ns	
		Orange		280			
		Yellow		90			
		Green		500			
C	Capacitance	High Efficiency Red		11		pF	$V_F = 0;$ $f = 1\text{ MHz}$
		Orange		4			
		Yellow		15			
		Green		18			
$R\theta_{J-PIN}$	Thermal Resistance	All		260		$^\circ\text{C/W}$	Junction to Cathode Lead
V_F	Forward Voltage	HER/Orange		1.9	2.4	V	$I_F = 10\text{ mA}$
		Yellow		2.0	2.4		
		Green		2.1	2.7		
V_R	Reverse Breakdown Voltage	All	5.0			V	$I_R = 100\ \mu\text{A}$
η_V	Luminous Efficacy	High Efficiency Red	–	145		$\frac{\text{lumens}}{\text{Watt}}$	See Note 3
		Orange		380			
		Yellow	–	500			
		Green		595			

Notes:

- $\theta^{1/2}$ is the off-axis angle at which the luminous intensity is half the axial luminous intensity.
- The dominant wavelength, λ_d , is derived from the CIE chromaticity diagram and represents the single wavelength which defines the color of the device.
- Radiant intensity, I_e , in Watts/steradian, may be found from the equation $I_e = I_v/\eta_V$, where I_v is the luminous intensity in candelas and η_V is the luminous efficacy in lumens/Watt.

Absolute Maximum Ratings at $T_A = 25^\circ\text{C}$

Parameter	HER/Orange	Yellow	Green/ Emerald Green	Units
Peak Forward Current	90	60	90	mA
Average Forward Current ^[1]	25	20	25	mA
DC Current ^[2]	30	20	30	mA
Power Dissipation ^[3]	135	85	135	mW
Reverse Voltage ($I_R = 100 \mu\text{A}$)	5	5	5	V
Transient Forward Current ^[4] (10 μsec Pulse)	500	500	500	mA
LED Junction Temperature	110	110	110	$^\circ\text{C}$
Operating Temperature Range	-55 to +100	-55 to +100	-20 to +100	$^\circ\text{C}$
Storage Temperature Range			-55 to +100	

Notes:

1. See Figure 5 (Red/Orange), 10 (Yellow), or 15 (Green) to establish pulsed operating conditions.
2. For Red, Orange and Green series derate linearly from 50°C at $0.5 \text{ mA}/^\circ\text{C}$. For Yellow series derate linearly from 50°C at $0.2 \text{ mA}/^\circ\text{C}$.
3. $1.8 \text{ mW}/^\circ\text{C}$. For Yellow series derate power linearly from 50°C at $1.6 \text{ mW}/^\circ\text{C}$.
4. The transient peak current is the maximum non-recurring peak current that can be applied to the device without damaging the LED die and wirebond. It is not recommended that the device be operated at peak currents beyond the peak forward current listed in the Absolute Maximum Ratings.

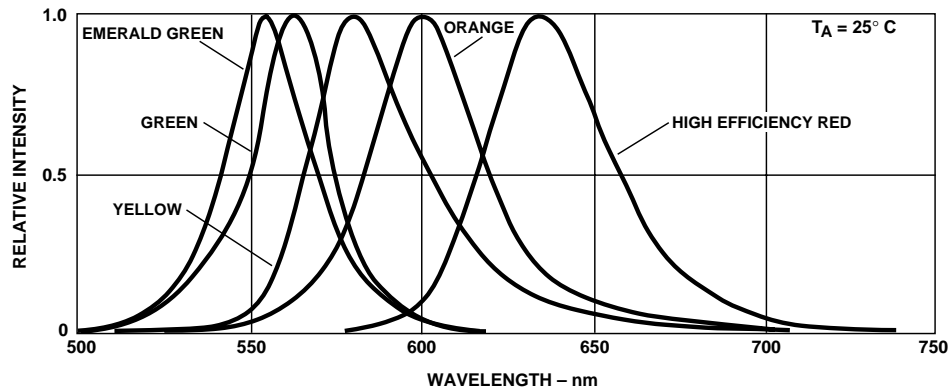

Figure 1. Relative intensity vs. wavelength.

T-13³/₄ High Efficiency Red, Orange Diffused Lamps

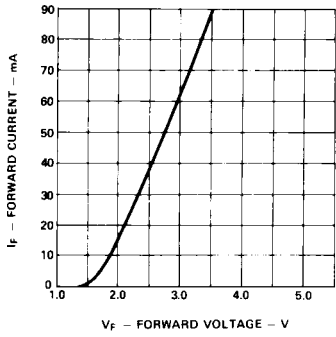

Figure 2. Forward current vs. forward voltage characteristics.

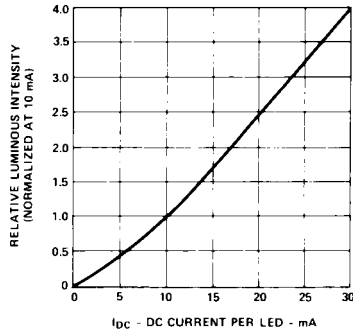

Figure 3. Relative luminous intensity vs. DC forward current.

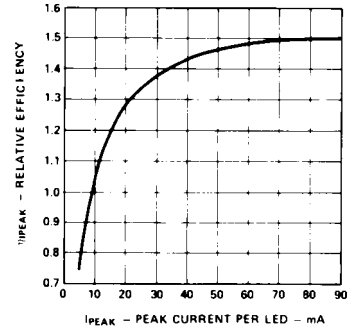

Figure 4. Relative efficiency (luminous intensity per unit current) vs. peak LED current.

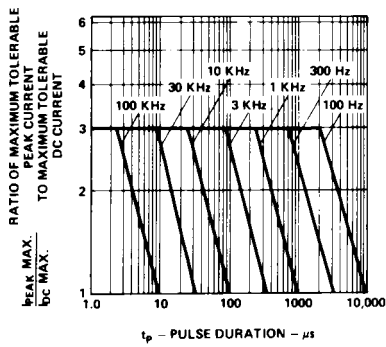

Figure 5. Maximum tolerable peak current vs. pulse duration. (I_{DC} MAX as per MAX ratings).

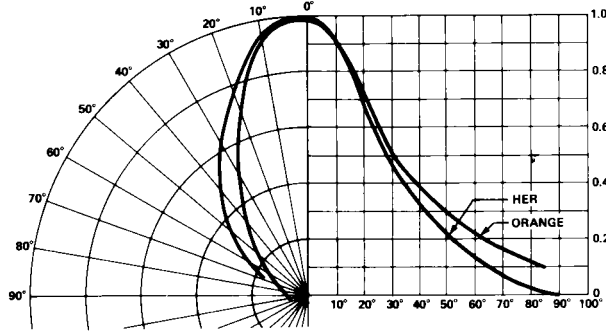

Figure 6. Relative luminous intensity vs. angular displacement.

T-13³/₄ Yellow Diffused Lamps

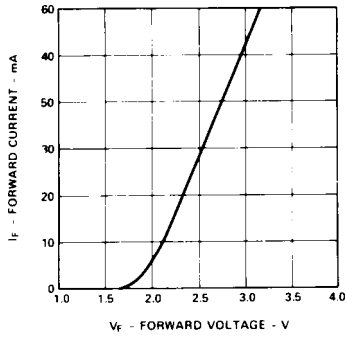

Figure 7. Forward current vs. forward voltage characteristics.

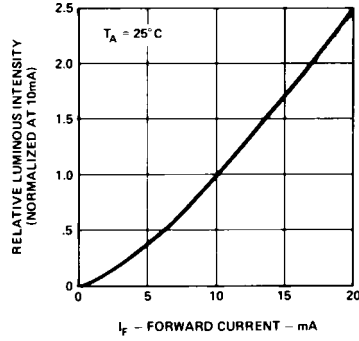

Figure 8. Relative luminous intensity vs. forward current.

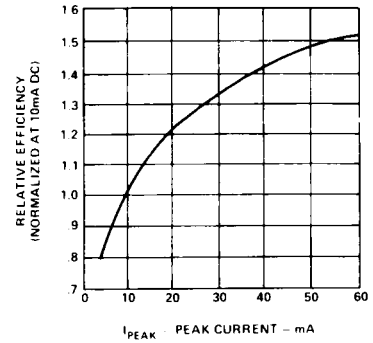

Figure 9. Relative efficiency (luminous intensity per unit current) vs. peak current.

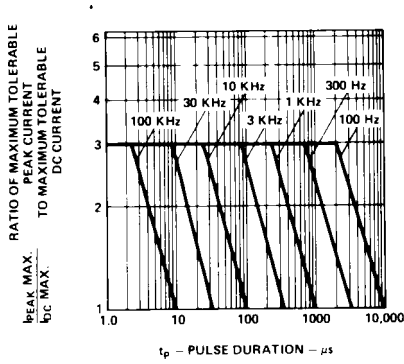

Figure 10. Maximum tolerable peak current vs. pulse duration. (I_{DC} MAX as per MAX ratings).

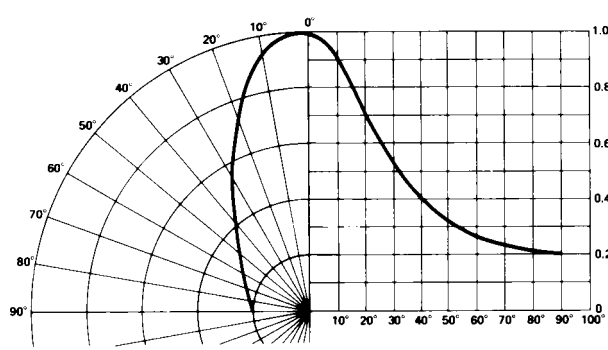

Figure 11. Relative luminous intensity vs. angular displacement.

T-13³/₄ Green/Emerald Green Diffused Lamps

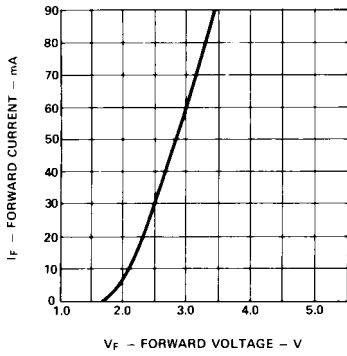

Figure 12. Forward current vs. forward voltage characteristics.

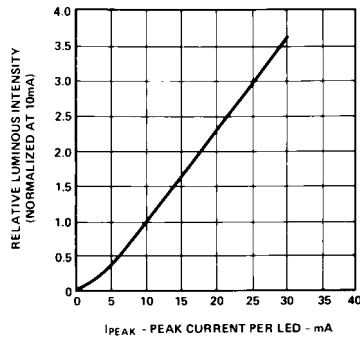

Figure 13. Relative luminous intensity vs. DC forward current.

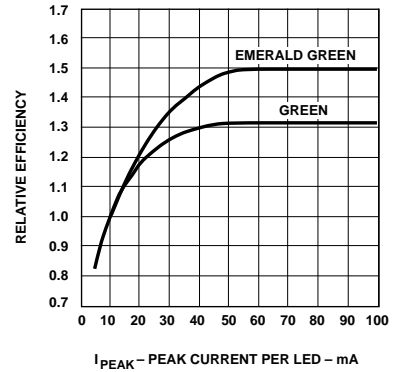

Figure 14. Relative efficiency (luminous intensity per unit current) vs. peak LED current.

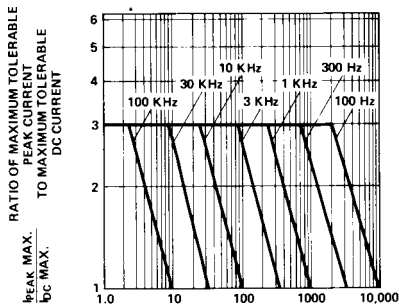

Figure 15. Maximum tolerable peak current vs. pulse duration. (I_{DC} MAX as per MAX ratings).

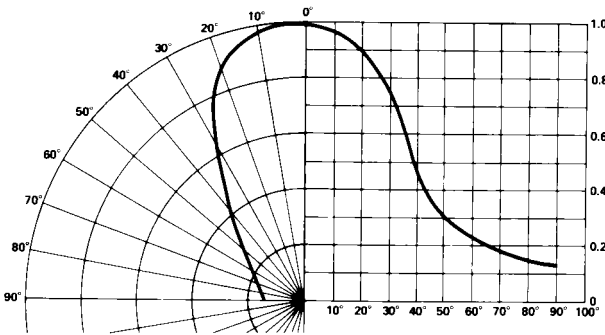

Figure 16. Relative luminous intensity vs. angular displacement.

Intensity Bin Limits

Color	Bin	Intensity Range (mcd)	
		Min.	Max.
Red/Orange	D	2.4	3.8
	E	3.8	6.1
	F	6.1	9.7
	G	9.7	15.5
	H	15.5	24.8
	I	24.8	39.6
	J	39.6	63.4
	K	63.4	101.5
	L	101.5	162.4
	M	162.4	234.6
	N	234.6	340.0
	O	340.0	540.0
	P	540.0	850.0
	Q	850.0	1200.0
	R	1200.0	1700.0
	S	1700.0	2400.0
	T	2400.0	3400.0
	U	3400.0	4900.0
	V	4900.0	7100.0
	W	7100.0	10200.0
X	10200.0	14800.0	
Y	14800.0	21400.0	
Z	21400.0	30900.0	
Yellow	E	6.5	10.3
	F	10.3	16.6
	G	16.6	26.5
	H	26.5	42.3
	I	42.3	67.7
	J	67.7	108.2
	K	108.2	173.2
	L	173.2	250.0
	M	250.0	360.0
	N	360.0	510.0
	O	510.0	800.0
	P	800.0	1250.0
	Q	1250.0	1800.0
R	1800.0	2900.0	
S	2900.0	4700.0	
T	4700.0	7200.0	
U	7200.0	11700.0	
V	11700.0	18000.0	
W	18000.0	27000.0	

Intensity Bin Limits, continued

Color	Bin	Intensity Range (mcd)	
		Min.	Max.
Green	D	4.7	7.6
	E	7.6	12.0
	F	12.0	19.1
	G	19.1	30.7
	H	30.7	49.1
	I	49.1	78.5
	J	78.5	125.7
	K	125.7	201.1
	L	201.1	289.0
	M	289.0	417.0
	N	417.0	680.0
	O	680.0	1100.0
	P	1100.0	1800.0
	Q	1800.0	2700.0
	R	2700.0	4300.0
	S	4300.0	6800.0
T	6800.0	10800.0	
U	10800.0	16000.0	
V	16000.0	25000.0	
W	25000.0	40000.0	

Maximum tolerance for each bin limit is $\pm 18\%$.

Color Categories

Color	Category #	Lambda (nm)	
		Min.	Max.
Green	6	561.5	564.5
	5	564.5	567.5
	4	567.5	570.5
	3	570.5	573.5
	2	573.5	576.5
Yellow	1	582.0	584.5
	3	584.5	587.0
	2	587.0	589.5
	4	589.5	592.0
	5	592.0	593.0
Orange	1	597.0	599.5
	2	599.5	602.0
	3	602.0	604.5
	4	604.5	607.5
	5	607.5	610.5
	6	610.5	613.5
	7	613.5	616.5
	8	616.5	619.5

Tolerance for each bin limit is ± 0.5 nm.

Mechanical Option Matrix

Mechanical Option Code	Definition
00	Bulk Packaging, minimum increment 500 pcs/bag
01	Tape & Reel, crimped leads, minimum increment 1300 pcs/bag
02	Tape & Reel, straight leads, minimum increment 1300 pcs/bag
B1	Right Angle Housing, uneven leads, minimum increment 500 pcs/bag
B2	Right Angle Housing, even leads, minimum increment 500 pcs/bag
DD	Ammo Pack, straight leads with minimum increment 2K/pack
R4	Tape & Reel, straight leads, counter clockwise, anode lead leaving the reel first

Note:

All categories are established for classification of products. Products may not be available in all categories. Please contact your local Agilent representative for further clarification/information.

Precautions

Lead Forming

- The leads of an LED lamp may be preformed or cut to length prior to insertion and soldering into PC board.
- If lead forming is required before soldering, care must be taken to avoid any excessive mechanical stress induced to LED package. Otherwise, cut the leads of LED to length after soldering process at room temperature. The solder joint formed will absorb the mechanical stress of the lead cutting from traveling to the LED chip die attach and wirebond.
- It is recommended that tooling made to precisely form and cut the leads to length rather than rely upon hand operation.

Soldering Conditions

- Care must be taken during PCB assembly and soldering process to prevent damage to LED component.
- The closest LED is allowed to solder on board is 1.59 mm below the body (encapsulant epoxy) for those parts without standoff.
- Recommended soldering conditions:

	Wave Soldering	Manual Solder Dipping
Pre-heat Temperature	105 °C Max.	–
Pre-heat Time	30 sec Max.	–
Peak Temperature	250 °C Max.	260 °C Max.
Dwell Time	3 sec Max.	5 sec Max.

- Wave soldering parameter must be set and maintained according to recommended temperature and dwell time in the solder wave. Customer is advised to periodically check on the soldering profile to ensure the soldering profile used is always conforming to recommended soldering condition.
- If necessary, use fixture to hold the LED component in proper orientation with respect to the PCB during soldering process.
- Proper handling is imperative to avoid excessive thermal stresses to LED components when heated. Therefore, the soldered PCB must be allowed to cool to room temperature, 25°C, before handling.
- Special attention must be given to board fabrication, solder masking, surface plating and lead holes size and component orientation to assure solderability.
- Recommended PC board plated through hole sizes for LED component leads:

LED Component Lead Size	Diagonal	Plated Through Hole Diameter
0.457 x 0.457 mm (0.018 x 0.018 inch)	0.646 mm (0.025 inch)	0.976 to 1.078 mm (0.038 to 0.042 inch)
0.508 x 0.508 mm (0.020 x 0.020 inch)	0.718 mm (0.028 inch)	1.049 to 1.150 mm (0.041 to 0.045 inch)

Note: Refer to application note AN1027 for more information on soldering LED components.

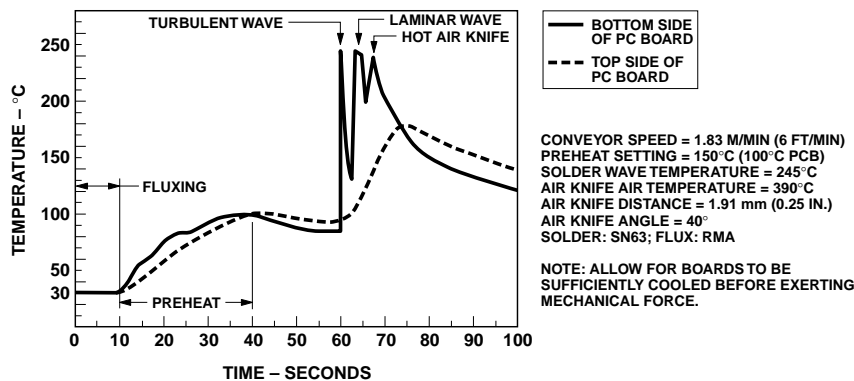

Figure 17. Recommended wave soldering profile.

www.agilent.com/semiconductors

For product information and a complete list of distributors, please go to our web site.

For technical assistance call:

Americas/Canada: +1 (800) 235-0312 or (916) 788-6763

Europe: +49 (0) 6441 92460

China: 10800 650 0017

Hong Kong: (+65) 6756 2394

India, Australia, New Zealand: (+65) 6755 1939

Japan: (+81 3) 3335-8152 (Domestic/International), or 0120-61-1280 (Domestic Only)

Korea: (+65) 6755 1989

Singapore, Malaysia, Vietnam, Thailand, Philippines, Indonesia: (+65) 6755 2044

Taiwan: (+65) 6755 1843

Data subject to change.

Copyright © 2000-2005 Agilent Technologies, Inc.

Obsoletes 5988-1857EN

November 15, 2005

5989-4258EN

