

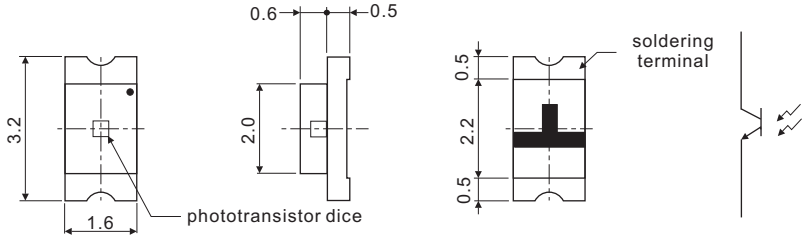







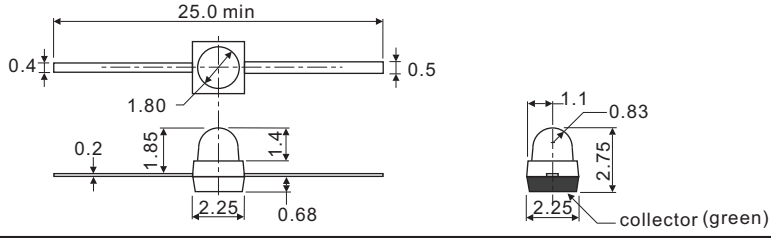

Phototransistors

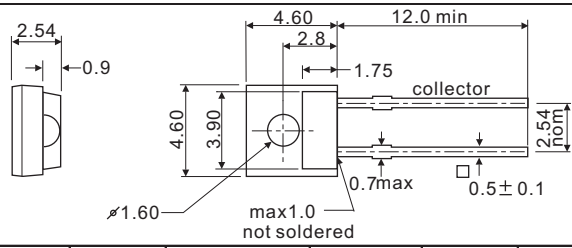
Ta=25°C

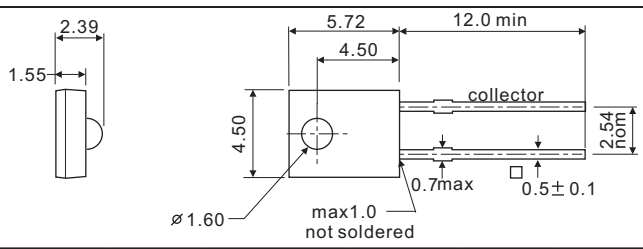
Device No	Lens Color	Sensitive Wavelength		VCEO	VECO	VCES (Ic=0.5mA)	Ic (Ee=0.5mw/cm ²)		Radiant Sensitive Area mm ²	View Angle 2θ1/2
		λp(nm)	λ(nm)	Min(V)	Typ(V)	Max(V)	Typ(mA)	VEC		
										
HPTCL-150D-4	Water clear	900	500~1100	20	5	0.4	0.4	5	0.19	140
										
HPTMIB-4DK	Water clear	900	500~1100	20	7	0.4	1.2	5	0.19	24
										
HPTB1-48B	Water clear	900	500~1100	30	5	0.4	0.5	5	0.19	40
HPTB1-48D	clear	900	500~1100	30	5	0.4	1.0	5	0.19	
										
HPTB1b-48D	Water clear	900	500~1100	30	5	0.4	1.0	5	0.19	40
										
HPTB3J-44D	Water clear	900	500~1100	30	5	0.4	1.2	5	0.19	60

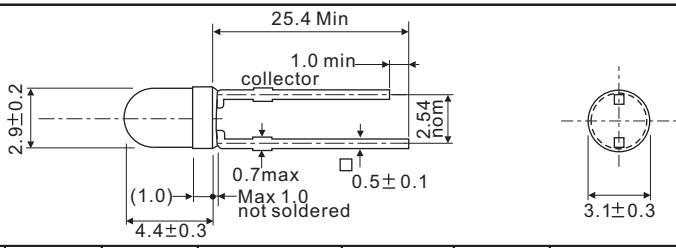
Phototransistors



Ta=25°C

Device No	Lens Color	Sensitive Wavelength		VCEO	VECO	VCES (Ic=0.5mA)	Ic (Ee=0.5mw/cm ²)		Radiant Sensitive Area mm ²	View Angle 2θ1/2
		λp(nm)	λ(nm)	Min(V)	Typ(V)	Max(V)	Typ(mA)	VEC		

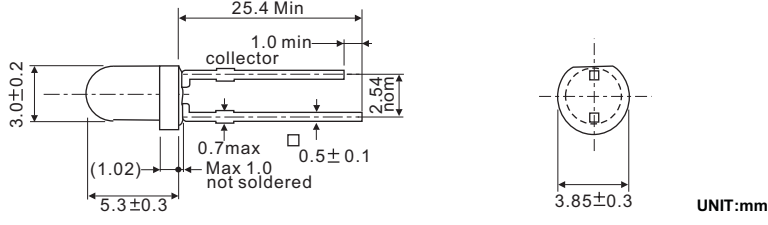
										
	HPTB3b-14D	Black	940	760~1000	30	5	0.4	1.5	5	0.19
HPTB3b-44D	Water clear	900	500~1100	30	5	0.4	1.5	5	0.19	

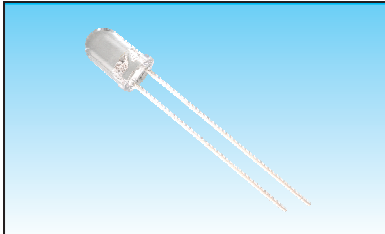
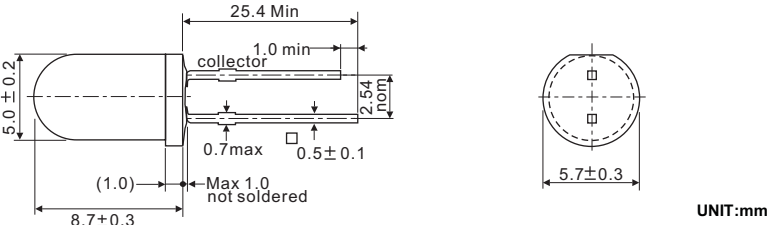
										
	HPTB5-44D-B	Water clear	900	500~1100	30	5	0.4	3.0	5	0.19
HPTB5-14D-B	Black	940	760~1000	30	5	0.4	3.0	5	0.19	30

Phototransistors For Ambient Light



Ta=25°C

Device No	Lens Color	Peak Wavelength	VCEO	VECO	VCES (Ic=2mA)	I _{RL} (Ee=1000Lux)	Sensitive Area (mm ²)	View Angle 2θ1/2
		λp(nm)	Min(V)	Typ(V)	Max(V)	Typ(μA)		

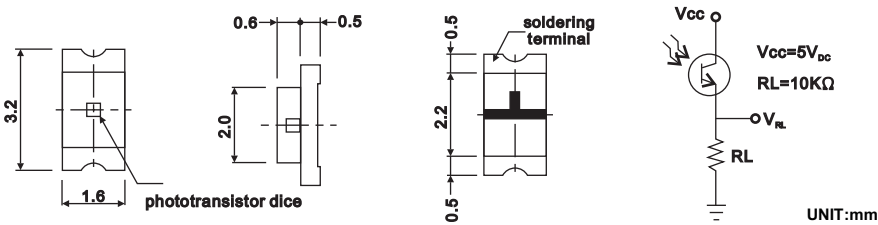
										
	HPTCL-150J	Water clear	570	30	5	0.3	150	0.38	140	

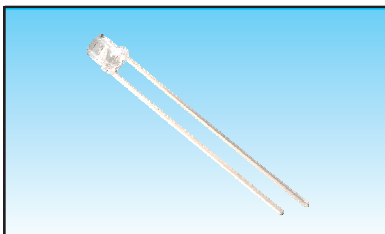
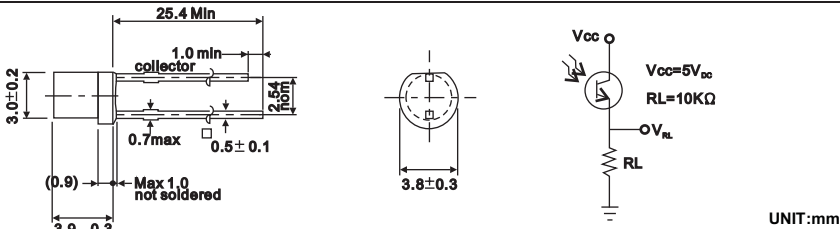
										
	HPTC3C-44J	Water clear	570	30	5	0.3	150	0.38	110	