

IRG4PC30UD

INSULATED GATE BIPOLAR TRANSISTOR WITH ULTRAFAST SOFT RECOVERY DIODE UltraFast CoPack IGBT

Features

- UltraFast: Optimized for high operating frequencies 8-40 kHz in hard switching, >200 kHz in resonant mode
- Generation 4 IGBT design provides tighter parameter distribution and higher efficiency than Generation 3
- IGBT co-packaged with HEXFRED™ ultrafast, ultra-soft-recovery anti-parallel diodes for use in bridge configurations
- Industry standard TO-247AC package

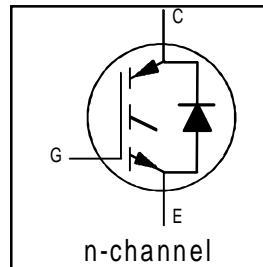

$V_{CES} = 600V$
$V_{CE(on) typ.} = 1.95V$
@ $V_{GE} = 15V, I_C = 12A$

Benefits

- Generation -4 IGBT's offer highest efficiencies available
- IGBT's optimized for specific application conditions
- HEXFRED diodes optimized for performance with IGBT's . Minimized recovery characteristics require less/no snubbing
- Designed to be a "drop-in" replacement for equivalent industry-standard Generation 3 IR IGBT's

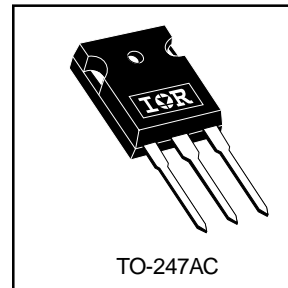

Absolute Maximum Ratings

	Parameter	Max.	Units
V_{CES}	Collector-to-Emitter Voltage	600	V
$I_C @ T_C = 25^\circ C$	Continuous Collector Current	23	A
$I_C @ T_C = 100^\circ C$	Continuous Collector Current	12	
I_{CM}	Pulsed Collector Current ①	92	
I_{LM}	Clamped Inductive Load Current ②	92	
$I_F @ T_C = 100^\circ C$	Diode Continuous Forward Current	12	
I_{FM}	Diode Maximum Forward Current	92	
V_{GE}	Gate-to-Emitter Voltage	± 20	V
$P_D @ T_C = 25^\circ C$	Maximum Power Dissipation	100	W
$P_D @ T_C = 100^\circ C$	Maximum Power Dissipation	42	
T_J	Operating Junction and Storage Temperature Range	-55 to +150	°C
T_{STG}			
	Soldering Temperature, for 10 sec.	300 (0.063 in. (1.6mm) from case)	
	Mounting Torque, 6-32 or M3 Screw.	10 lbf•in (1.1 N•m)	

Thermal Resistance

	Parameter	Min.	Typ.	Max.	Units
$R_{\theta JC}$	Junction-to-Case - IGBT	-----	-----	1.2	°C/W
$R_{\theta JC}$	Junction-to-Case - Diode	-----	-----	2.5	
$R_{\theta CS}$	Case-to-Sink, flat, greased surface	-----	0.24	-----	
$R_{\theta JA}$	Junction-to-Ambient, typical socket mount	-----	-----	40	
Wt	Weight	-----	6 (0.21)	-----	g (oz)

Electrical Characteristics @ T_J = 25°C (unless otherwise specified)

	Parameter	Min.	Typ.	Max.	Units	Conditions
V _{(BR)CES}	Collector-to-Emitter Breakdown Voltage ^③	600	----	----	V	V _{GE} = 0V, I _C = 250μA
ΔV _{(BR)CES} /ΔT _J	Temperature Coeff. of Breakdown Voltage	----	0.63	----	V/°C	V _{GE} = 0V, I _C = 1.0mA
V _{CE(on)}	Collector-to-Emitter Saturation Voltage	----	1.95	2.1	V	I _C = 12A V _{GE} = 15V
		----	2.52	----		I _C = 23A See Fig. 2, 5
		----	2.09	----		I _C = 12A, T _J = 150°C
V _{GE(th)}	Gate Threshold Voltage	3.0	----	6.0		V _{CE} = V _{GE} , I _C = 250μA
ΔV _{GE(th)} /ΔT _J	Temperature Coeff. of Threshold Voltage	----	-11	----	mV/°C	V _{CE} = V _{GE} , I _C = 250μA
g _{fe}	Forward Transconductance ^④	3.1	8.6	----	S	V _{CE} = 100V, I _C = 12A
I _{CES}	Zero Gate Voltage Collector Current	----	----	250	μA	V _{GE} = 0V, V _{CE} = 600V
		----	----	2500		V _{GE} = 0V, V _{CE} = 600V, T _J = 150°C
V _{FM}	Diode Forward Voltage Drop	----	1.4	1.7	V	I _C = 12A See Fig. 13
		----	1.3	1.6		I _C = 12A, T _J = 150°C
I _{GES}	Gate-to-Emitter Leakage Current	----	----	±100	nA	V _{GE} = ±20V

Switching Characteristics @ T_J = 25°C (unless otherwise specified)

	Parameter	Min.	Typ.	Max.	Units	Conditions	
Q _g	Total Gate Charge (turn-on)	----	50	75	nC	I _C = 12A	
Q _{ge}	Gate - Emitter Charge (turn-on)	----	8.1	12		V _{CC} = 400V See Fig. 8	
Q _{gc}	Gate - Collector Charge (turn-on)	----	18	27		V _{GE} = 15V	
t _{d(on)}	Turn-On Delay Time	----	40	----	ns	T _J = 25°C	
t _r	Rise Time	----	21	----		I _C = 12A, V _{CC} = 480V	
t _{d(off)}	Turn-Off Delay Time	----	91	140		V _{GE} = 15V, R _G = 23Ω	
t _f	Fall Time	----	80	130	mJ	Energy losses include "tail" and diode reverse recovery. See Fig. 9, 10, 11, 18	
E _{on}	Turn-On Switching Loss	----	0.38	----			
E _{off}	Turn-Off Switching Loss	----	0.16	----			
E _{ts}	Total Switching Loss	----	0.54	0.9	mJ	T _J = 150°C, See Fig. 9, 10, 11, 18	
t _{d(on)}	Turn-On Delay Time	----	40	----		ns	I _C = 12A, V _{CC} = 480V
t _r	Rise Time	----	22	----			V _{GE} = 15V, R _G = 23Ω
t _{d(off)}	Turn-Off Delay Time	----	120	----	Energy losses include "tail" and diode reverse recovery.		
t _f	Fall Time	----	180	----	mJ		
E _{ts}	Total Switching Loss	----	0.89	----			
L _E	Internal Emitter Inductance	----	13	----		nH	Measured 5mm from package
C _{ies}	Input Capacitance	----	1100	----	pF	V _{GE} = 0V	
C _{oes}	Output Capacitance	----	73	----		V _{CC} = 30V See Fig. 7	
C _{res}	Reverse Transfer Capacitance	----	14	----		f = 1.0MHz	
t _{rr}	Diode Reverse Recovery Time	----	42	60	ns	T _J = 25°C See Fig. 14	
		----	80	120		T _J = 125°C	
I _{rr}	Diode Peak Reverse Recovery Current	----	3.5	6.0	A	T _J = 25°C See Fig. 15	
		----	5.6	10		T _J = 125°C	
Q _{rr}	Diode Reverse Recovery Charge	----	80	180	nC	T _J = 25°C See Fig. 16	
		----	220	600		T _J = 125°C	
di _(rec) M/dt	Diode Peak Rate of Fall of Recovery During t _b	----	180	----	A/μs	T _J = 25°C See Fig. 17	
		----	120	----		T _J = 125°C	

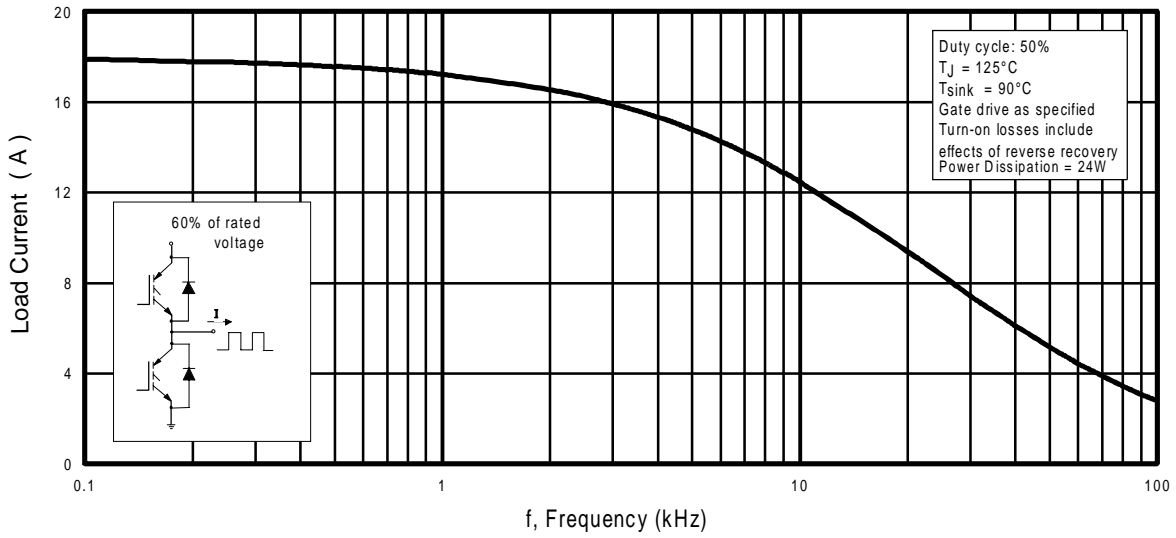

Fig. 1 - Typical Load Current vs. Frequency
 (Load Current = I_{RMS} of fundamental)

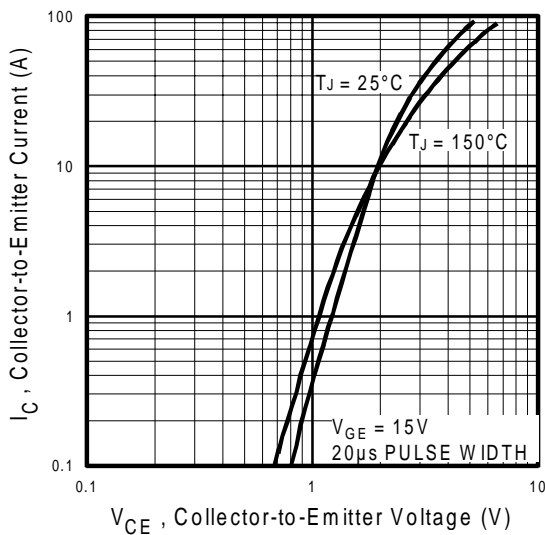

Fig. 2 - Typical Output Characteristics

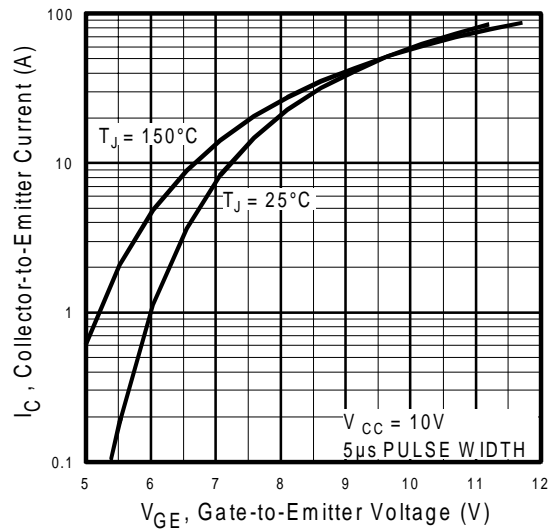

Fig. 3 - Typical Transfer Characteristics

IRG4PC30UD

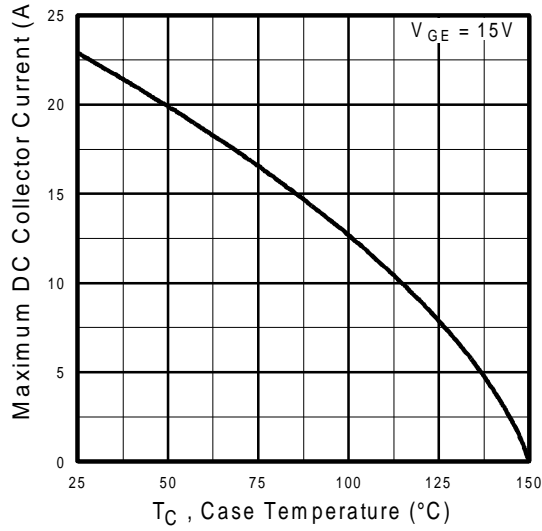

Fig. 4 - Maximum Collector Current vs. Case Temperature

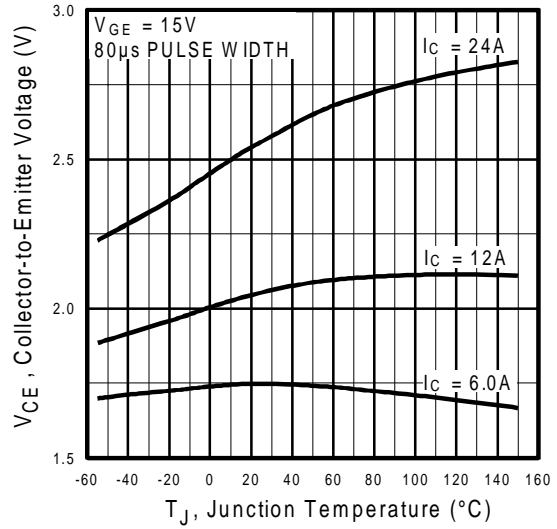

Fig. 5 - Typical Collector-to-Emitter Voltage vs. Junction Temperature

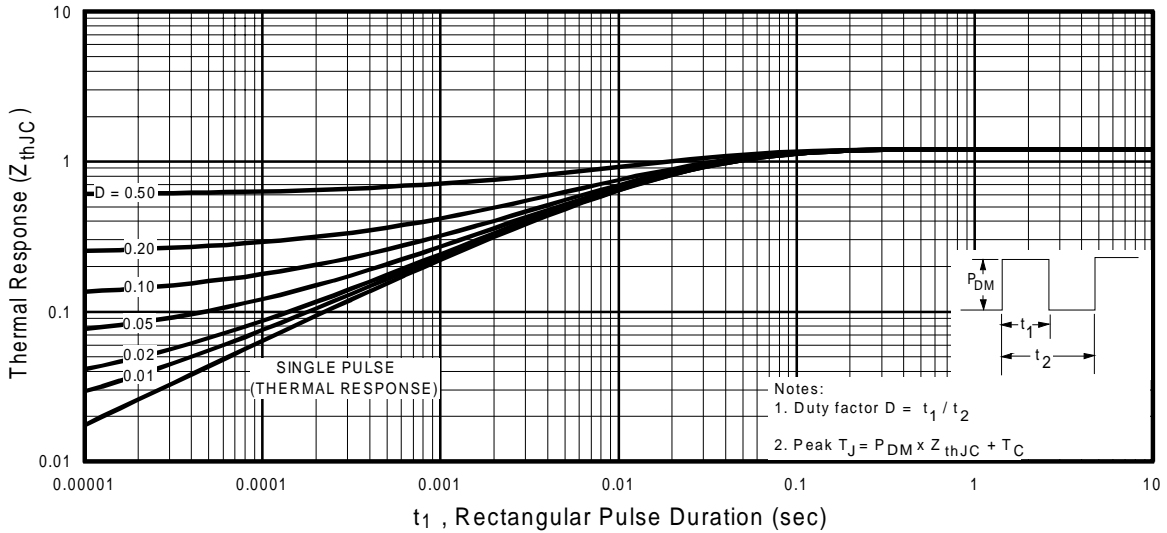

Fig. 6 - Maximum IGBT Effective Transient Thermal Impedance, Junction-to-Case

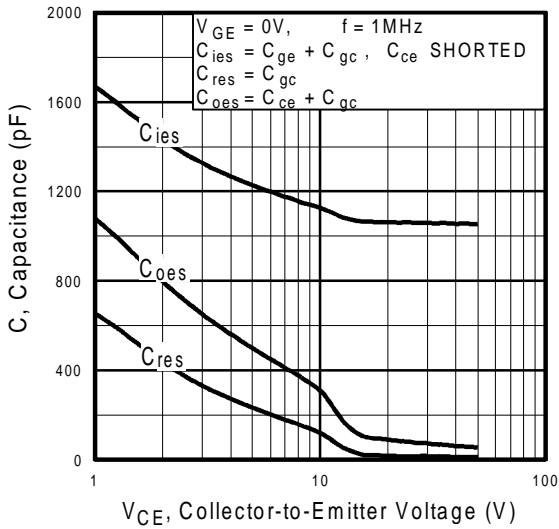

Fig. 7 - Typical Capacitance vs. Collector-to-Emitter Voltage

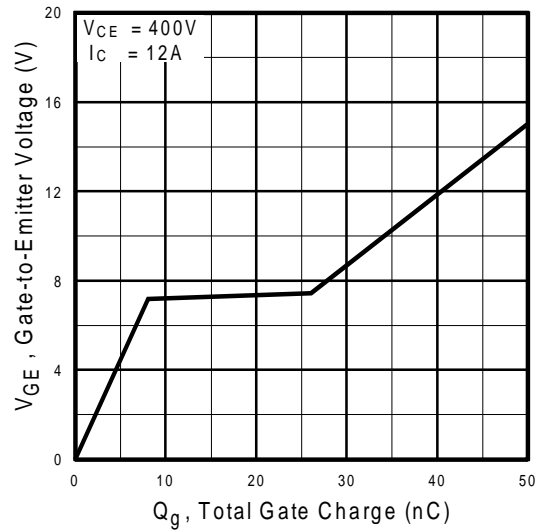

Fig. 8 - Typical Gate Charge vs. Gate-to-Emitter Voltage

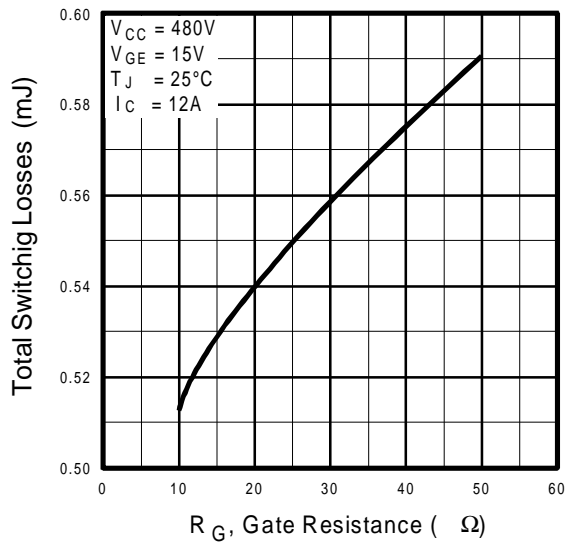

Fig. 9 - Typical Switching Losses vs. Gate Resistance

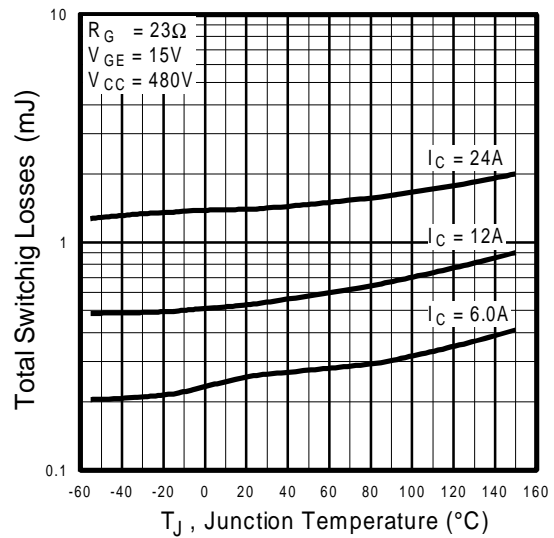

Fig. 10 - Typical Switching Losses vs. Junction Temperature

IRG4PC30UD

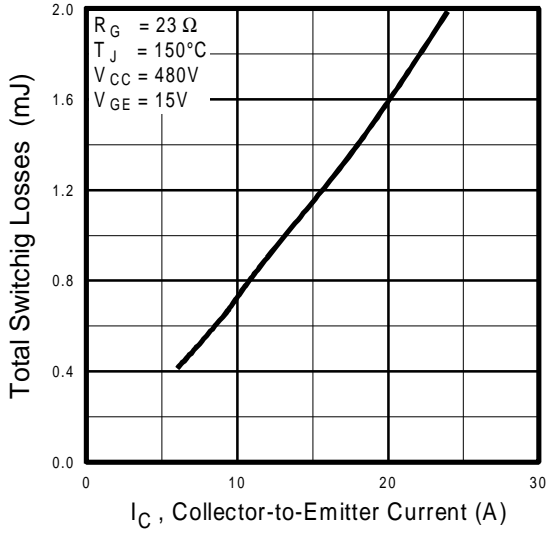

Fig. 11 - Typical Switching Losses vs. Collector-to-Emitter Current

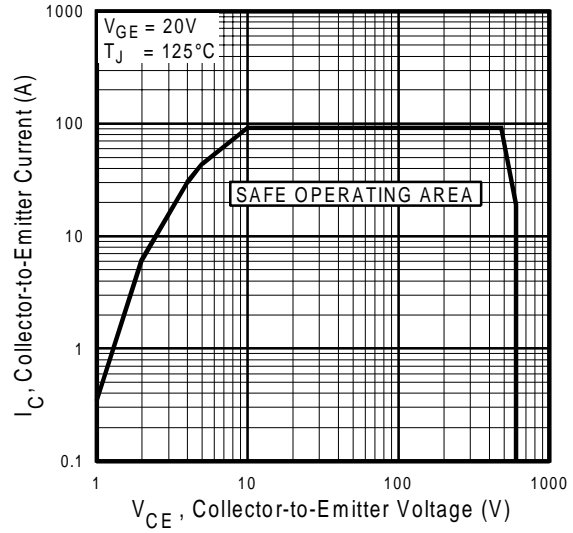

Fig. 12 - Turn-Off SOA

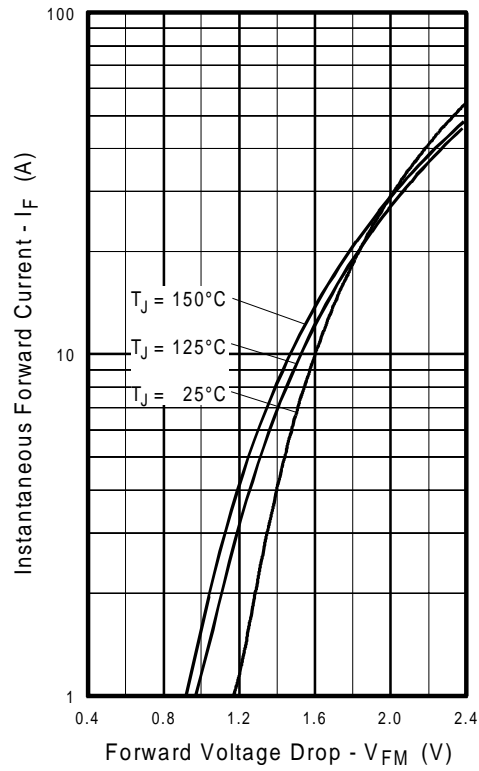

Fig. 13 - Maximum Forward Voltage Drop vs. Instantaneous Forward Current

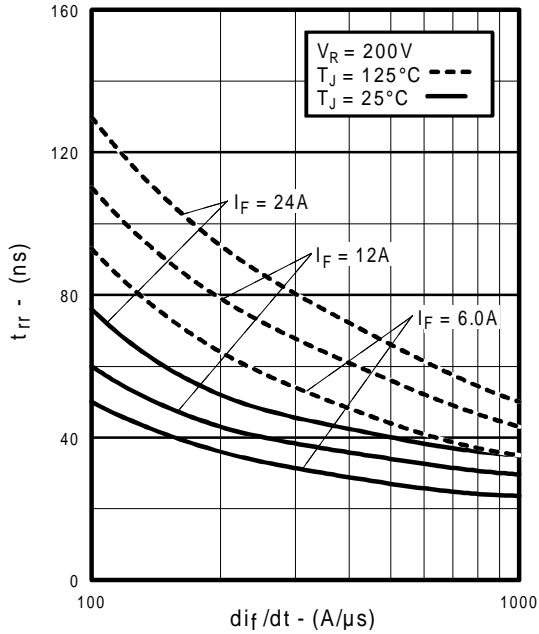

Fig. 14 - Typical Reverse Recovery vs. di_f/dt

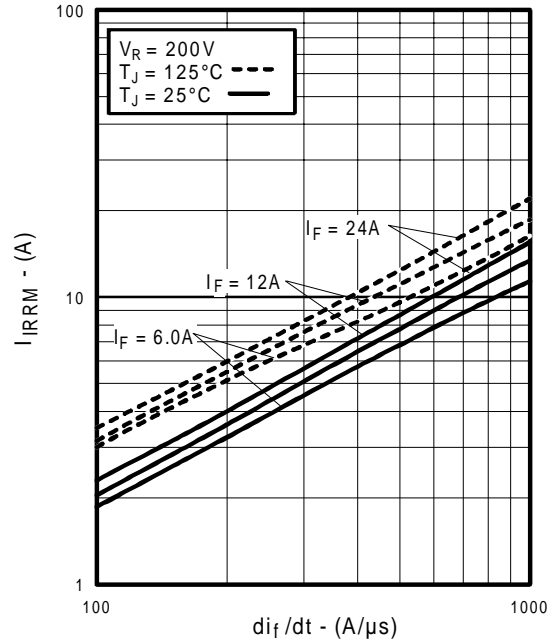

Fig. 15 - Typical Recovery Current vs. di_f/dt

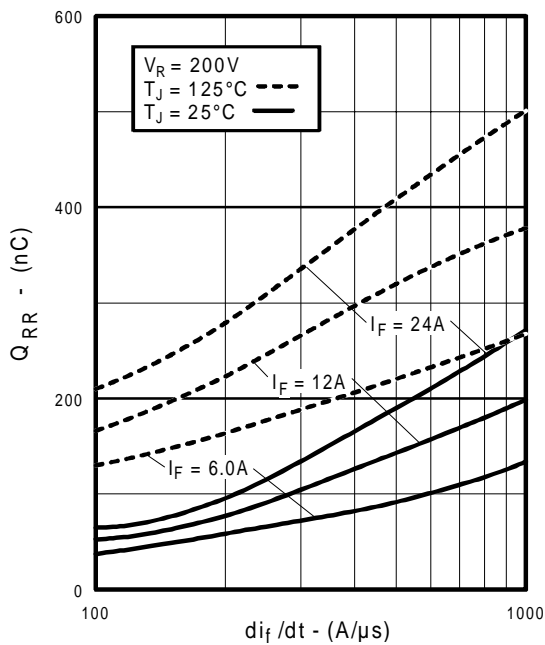

Fig. 16 - Typical Stored Charge vs. di_f/dt

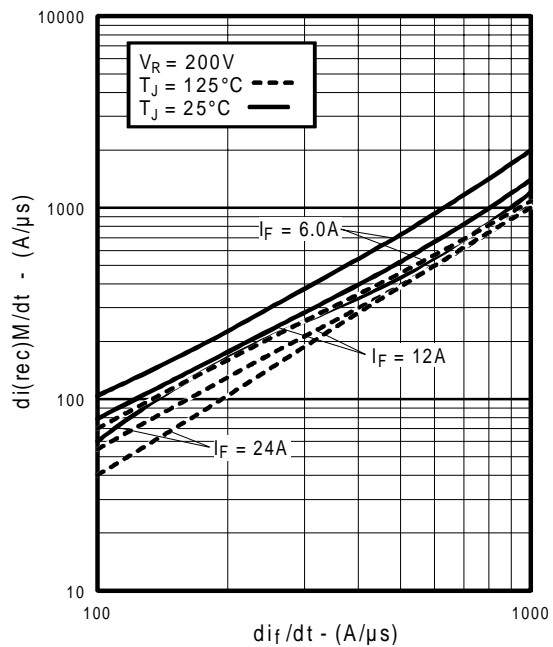

Fig. 17 - Typical $di_{(rec)M}/dt$ vs. di_f/dt

IRG4PC30UD

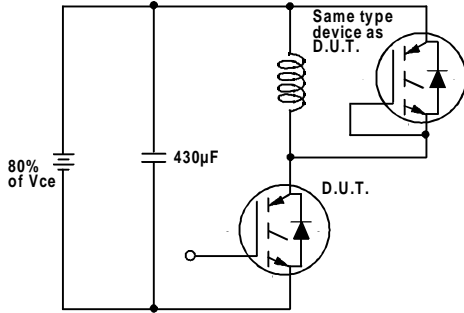

Fig. 18a - Test Circuit for Measurement of I_{LM} , E_{on} , $E_{off}(\text{diode})$, t_{rr} , Q_{rr} , I_{rr} , $t_{d(on)}$, t_r , $t_{d(off)}$, t_f

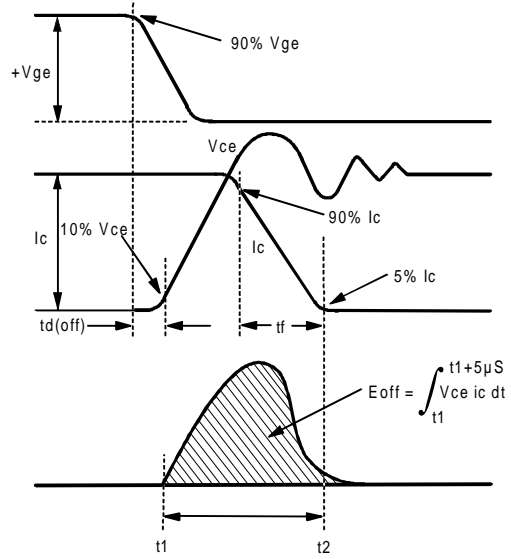

Fig. 18b - Test Waveforms for Circuit of Fig. 18a, Defining E_{off} , $t_{d(off)}$, t_f

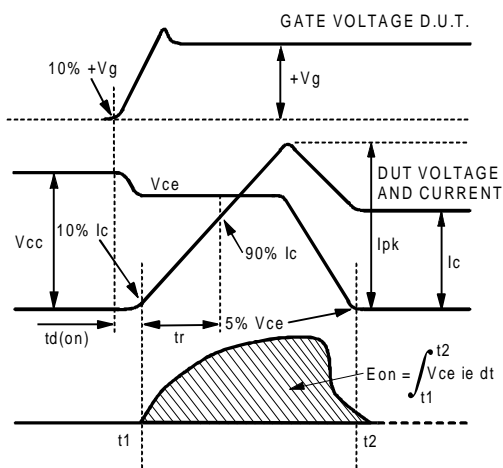

Fig. 18c - Test Waveforms for Circuit of Fig. 18a, Defining E_{on} , $t_{d(on)}$, t_r

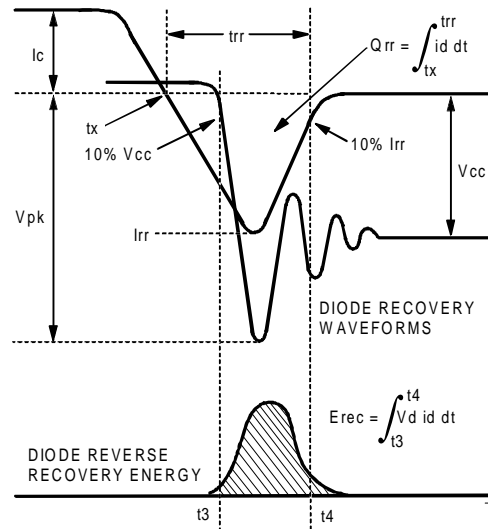

Fig. 18d - Test Waveforms for Circuit of Fig. 18a, Defining E_{rec} , t_{rr} , Q_{rr} , I_{rr}

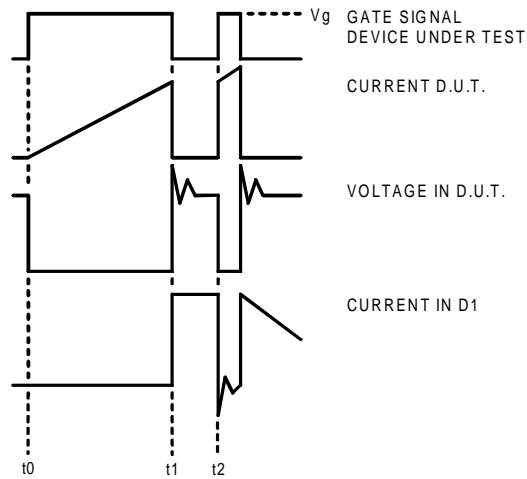

Figure 18e. Macro Waveforms for Figure 18a's Test Circuit



Figure 19. Clamped Inductive Load Test Circuit



Figure 20. Pulsed Collector Current Test Circuit

IRG4PC30UD

Notes:

- ① Repetitive rating: $V_{GE}=20V$; pulse width limited by maximum junction temperature (figure 20)
- ② $V_{CC}=80\%(V_{CES})$, $V_{GE}=20V$, $L=10\mu H$, $R_G = 23\Omega$ (figure 19)
- ③ Pulse width $\leq 80\mu s$; duty factor $\leq 0.1\%$.
- ④ Pulse width $5.0\mu s$, single shot.

Case Outline — TO-247AC

