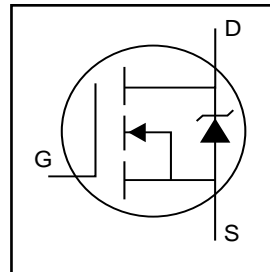


## HEXFET® Power MOSFET

- Logic-Level Gate Drive
- Advanced Process Technology
- Isolated Package
- High Voltage Isolation = 2.5KVRMS ⑤
- Sink to Lead Creepage Dist. = 4.8mm
- Fully Avalanche Rated



$$V_{DSS} = 100V$$

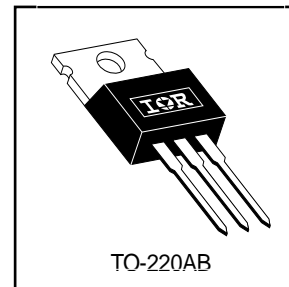
$$R_{DS(on)} = 0.044\Omega$$

$$I_D = 30A$$

### Description

Fifth Generation HEXFETs from International Rectifier utilize advanced processing techniques to achieve extremely low on-resistance per silicon area. This benefit, combined with the fast switching speed and ruggedized device design that HEXFET Power MOSFETs are well known for, provides the designer with an extremely efficient and reliable device for use in a wide variety of applications.

The TO-220 package is universally preferred for all commercial-industrial applications at power dissipation levels to approximately 50 watts. The low thermal resistance and low package cost of the TO-220 contribute to its wide acceptance throughout the industry.



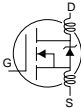
### Absolute Maximum Ratings

	Parameter	Max.	Units
$I_D @ T_C = 25^\circ C$	Continuous Drain Current, $V_{GS} @ 10V$	30	A
$I_D @ T_C = 100^\circ C$	Continuous Drain Current, $V_{GS} @ 10V$	21	
$I_{DM}$	Pulsed Drain Current ①	120	
$P_D @ T_C = 25^\circ C$	Power Dissipation	94	W
	Linear Derating Factor	0.63	W/°C
$V_{GS}$	Gate-to-Source Voltage	$\pm 16$	V
$E_{AS}$	Single Pulse Avalanche Energy②	310	mJ
$I_{AR}$	Avalanche Current①	18	A
$E_{AR}$	Repetitive Avalanche Energy①	9.4	mJ
dv/dt	Peak Diode Recovery dv/dt ③	4.3	V/ns
$T_J$	Operating Junction and	-55 to + 175	°C
$T_{STG}$	Storage Temperature Range		
	Soldering Temperature, for 10 seconds	300 (1.6mm from case )	
	Mounting torque, 6-32 or M3 screw	10 lbf•in (1.1N•m)	

### Thermal Resistance

	Parameter	Typ.	Max.	Units
$R_{\theta JC}$	Junction-to-Case	—	1.6	°C/W
$R_{\theta CS}$	Case-to-Sink, Flat, Greased Surface	0.50	—	
$R_{\theta JA}$	Junction-to-Ambient	—	62	

## Electrical Characteristics @ $T_J = 25^\circ\text{C}$ (unless otherwise specified)

	Parameter	Min.	Typ.	Max.	Units	Conditions
$V_{(BR)DSS}$	Drain-to-Source Breakdown Voltage	100	—	—	V	$V_{GS} = 0V, I_D = 250\mu A$
$\Delta V_{(BR)DSS}/\Delta T_J$	Breakdown Voltage Temp. Coefficient	—	0.11	—	V/ $^\circ\text{C}$	Reference to $25^\circ\text{C}, I_D = 1\text{mA}$
$R_{DS(on)}$	Static Drain-to-Source On-Resistance	—	—	0.044	$\Omega$	$V_{GS} = 10V, I_D = 18A$ ④
		—	—	0.053		$V_{GS} = 5.0V, I_D = 18A$ ④
		—	—	0.063		$V_{GS} = 4.0V, I_D = 15A$ ④
$V_{GS(th)}$	Gate Threshold Voltage	1.0	—	2.0	V	$V_{DS} = V_{GS}, I_D = 250\mu A$
$g_{fs}$	Forward Transconductance	14	—	—	S	$V_{DS} = 25V, I_D = 18A$
$I_{DSS}$	Drain-to-Source Leakage Current	—	—	25	$\mu A$	$V_{DS} = 100V, V_{GS} = 0V$
		—	—	250		$V_{DS} = 80V, V_{GS} = 0V, T_J = 150^\circ\text{C}$
$I_{GSS}$	Gate-to-Source Forward Leakage	—	—	100	nA	$V_{GS} = 16V$
	Gate-to-Source Reverse Leakage	—	—	-100		$V_{GS} = -16V$
$Q_g$	Total Gate Charge	—	—	74	nC	$I_D = 18A$
$Q_{gs}$	Gate-to-Source Charge	—	—	9.4		$V_{DS} = 5.0V$
$Q_{gd}$	Gate-to-Drain ("Miller") Charge	—	—	38		$V_{GS} = 5.0V$ , See Fig. 6 and 13 ④
$t_{d(on)}$	Turn-On Delay Time	—	11	—	ns	$V_{DD} = 50V$
$t_r$	Rise Time	—	81	—		$I_D = 18A$
$t_{d(off)}$	Turn-Off Delay Time	—	39	—		$R_G = 5.0\Omega, V_{GS} = 5.0V$
$t_f$	Fall Time	—	62	—		$R_D = 2.7\Omega$ , See Fig. 10 ④
$L_D$	Internal Drain Inductance	—	4.5	—	nH	Between lead, 6mm (0.25in.) from package and center of die contact
$L_S$	Internal Source Inductance	—	7.5	—		
$C_{iss}$	Input Capacitance	—	1800	—	pF	$V_{GS} = 0V$
$C_{oss}$	Output Capacitance	—	350	—		$V_{DS} = 25V$
$C_{rss}$	Reverse Transfer Capacitance	—	170	—		$f = 1.0\text{MHz}$ , See Fig. 5

## Source-Drain Ratings and Characteristics

	Parameter	Min.	Typ.	Max.	Units	Conditions
$I_S$	Continuous Source Current (Body Diode)	—	—	30	A	MOSFET symbol showing the integral reverse p-n junction diode.
$I_{SM}$	Pulsed Source Current (Body Diode) ①⑥	—	—	120		
$V_{SD}$	Diode Forward Voltage	—	—	1.3	V	$T_J = 25^\circ\text{C}, I_S = 18A, V_{GS} = 0V$ ④
$t_{rr}$	Reverse Recovery Time	—	190	290	ns	$T_J = 25^\circ\text{C}, I_F = 18A$
$Q_{rr}$	Reverse Recovery Charge	—	1.1	1.7	$\mu C$	$di/dt = 100A/\mu s$ ④
$t_{on}$	Forward Turn-On Time	Intrinsic turn-on time is negligible (turn-on is dominated by $L_S + L_D$ )				

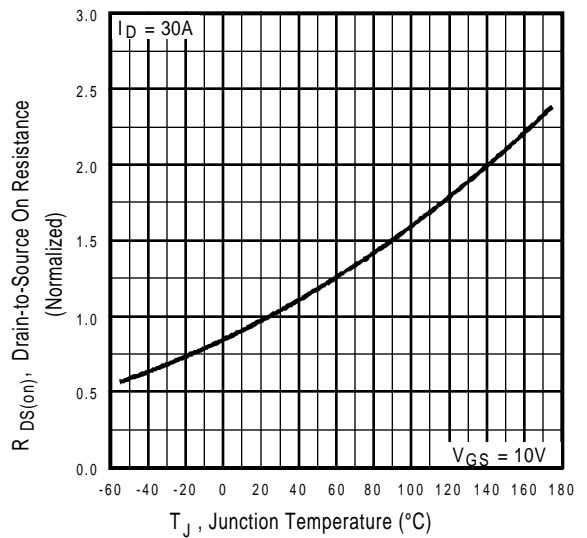
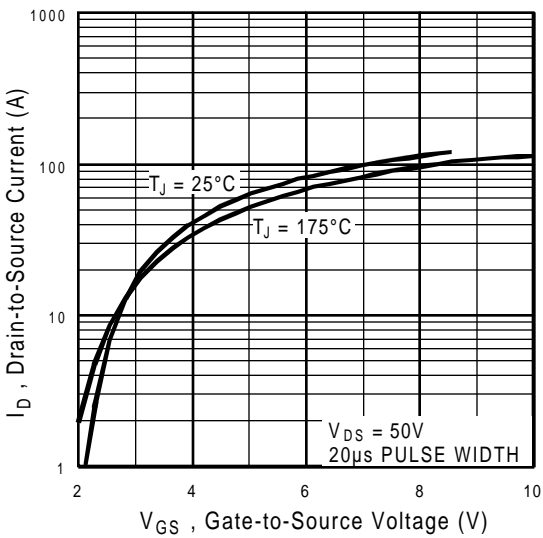
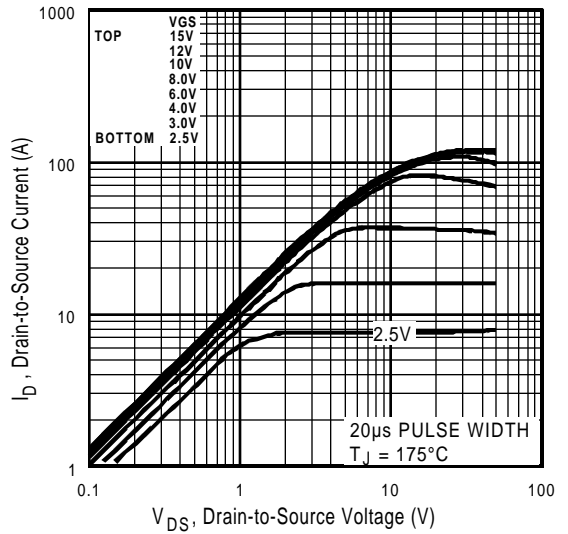
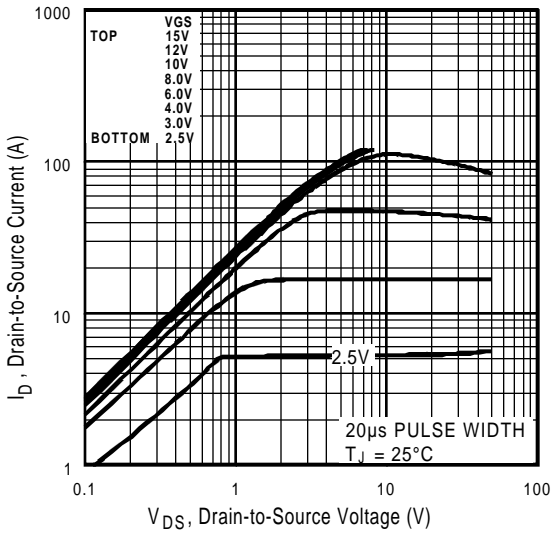
### Notes:

① Repetitive rating; pulse width limited by max. junction temperature. ( See fig. 11 )

② Starting  $T_J = 25^\circ\text{C}, L = 1.9\text{mH}$   
 $R_G = 25\Omega, I_{AS} = 18A$ . (See Figure 12)

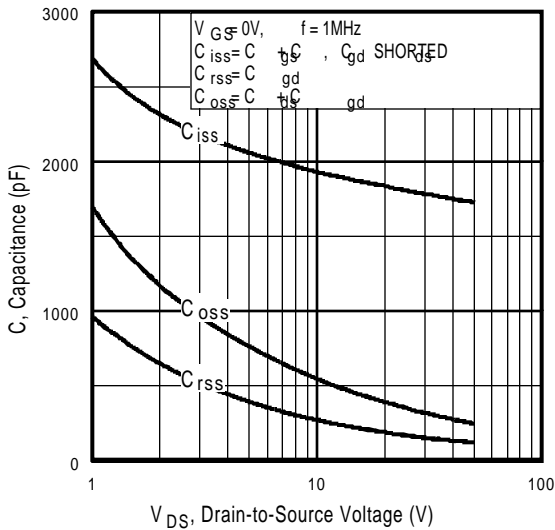
③  $I_{SD} \leq 18A, di/dt \leq 180A/\mu s, V_{DD} \leq V_{(BR)DSS}, T_J \leq 175^\circ\text{C}$

④ Pulse width  $\leq 300\mu s$ ; duty cycle  $\leq 2\%$

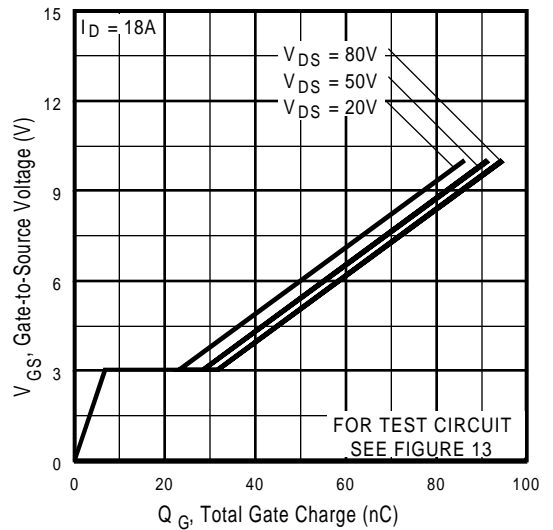


**Fig 3. Typical Transfer Characteristics**

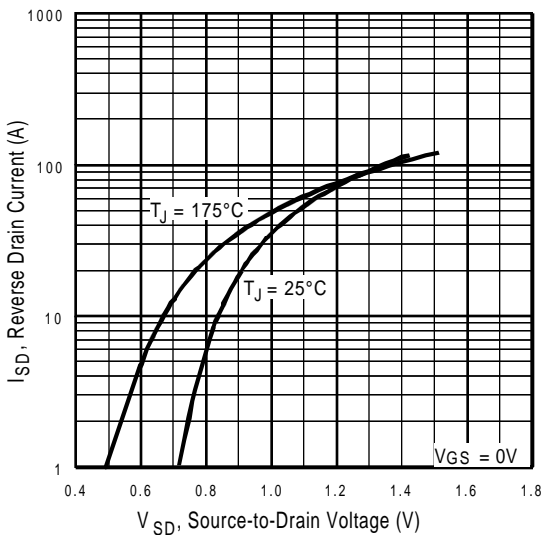
**Fig 4. Normalized On-Resistance Vs. Temperature**



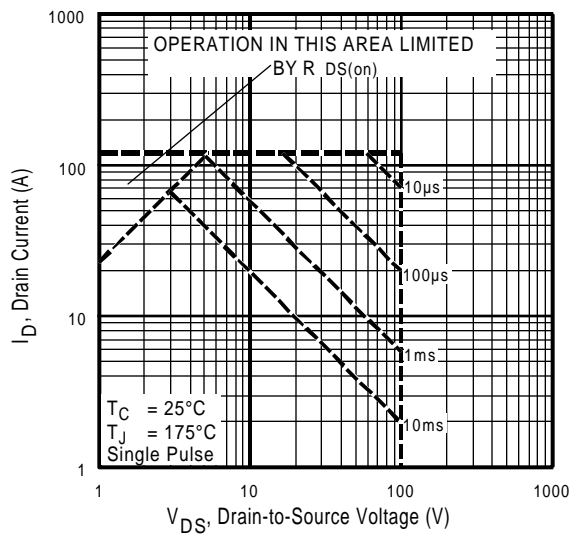
**Fig 5.** Typical Capacitance Vs. Drain-to-Source Voltage



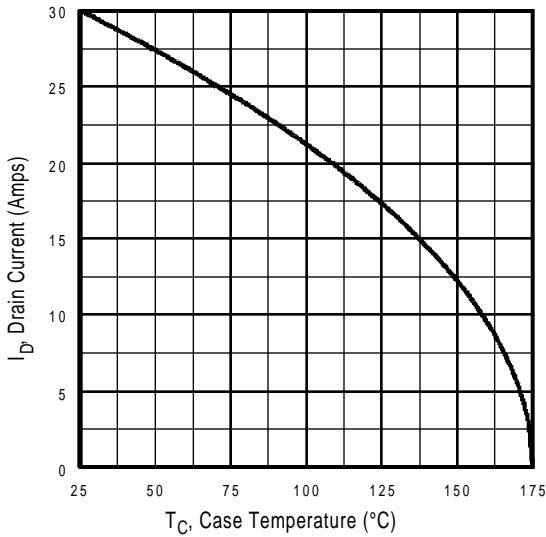
**Fig 6.** Typical Gate Charge Vs. Gate-to-Source Voltage



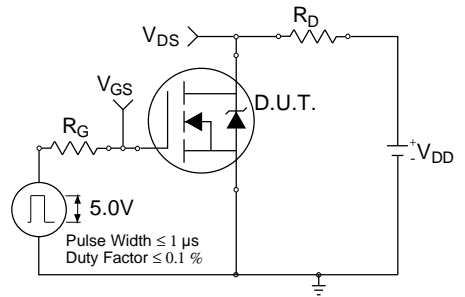
**Fig 7.** Typical Source-Drain Diode Forward Voltage



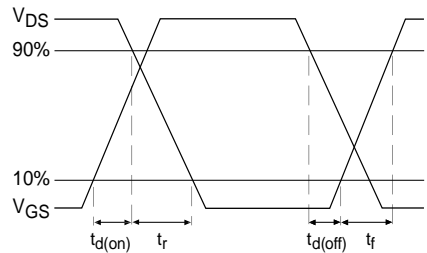
**Fig 8.** Maximum Safe Operating Area



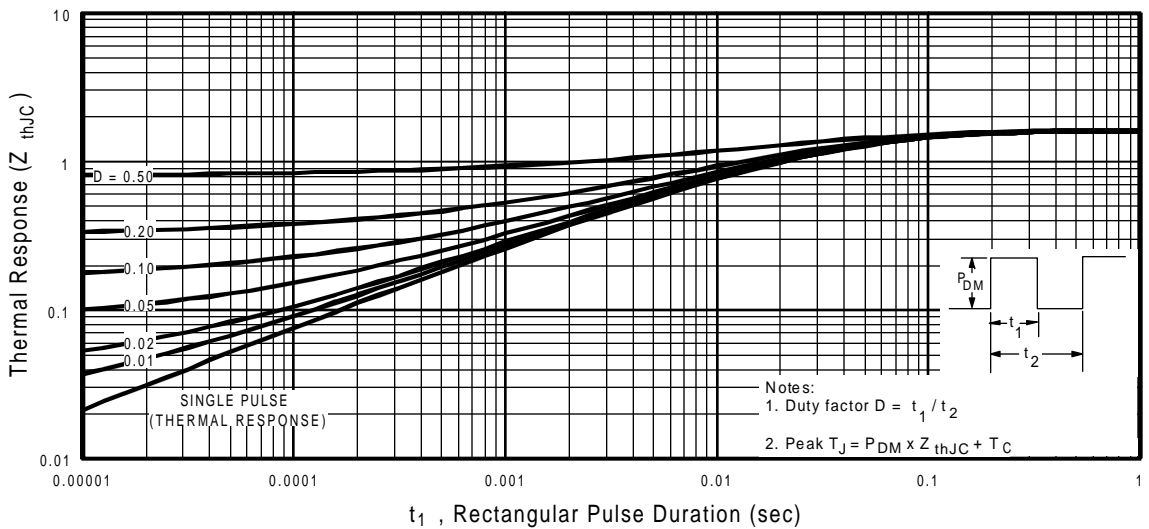
**Fig 9.** Maximum Drain Current Vs. Case Temperature



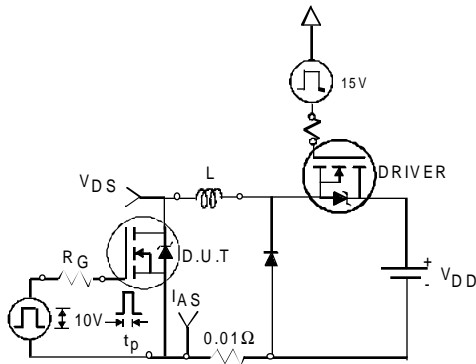
**Fig 10a.** Switching Time Test Circuit



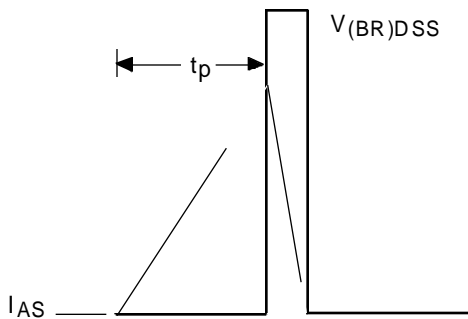
**Fig 10b.** Switching Time Waveforms



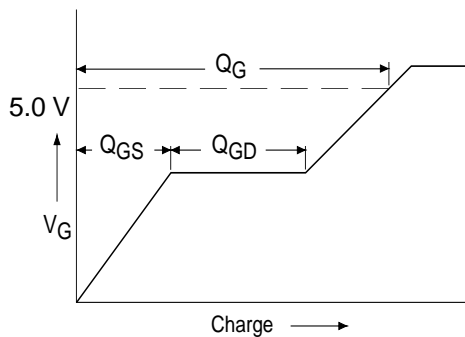
**Fig 11.** Maximum Effective Transient Thermal Impedance, Junction-to-Case



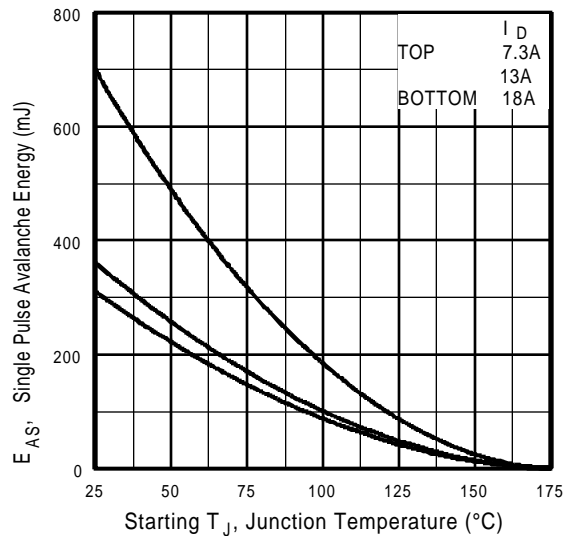
**Fig 12a.** Unclamped Inductive Test Circuit



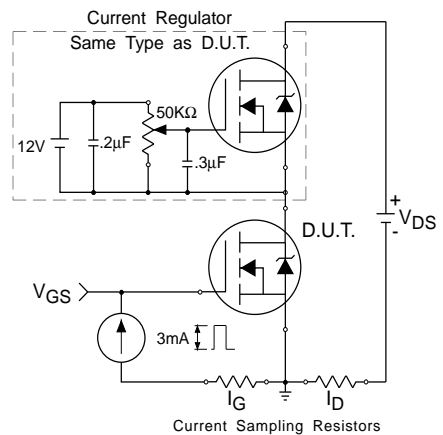
**Fig 12b.** Unclamped Inductive Waveforms



**Fig 13a.** Basic Gate Charge Waveform

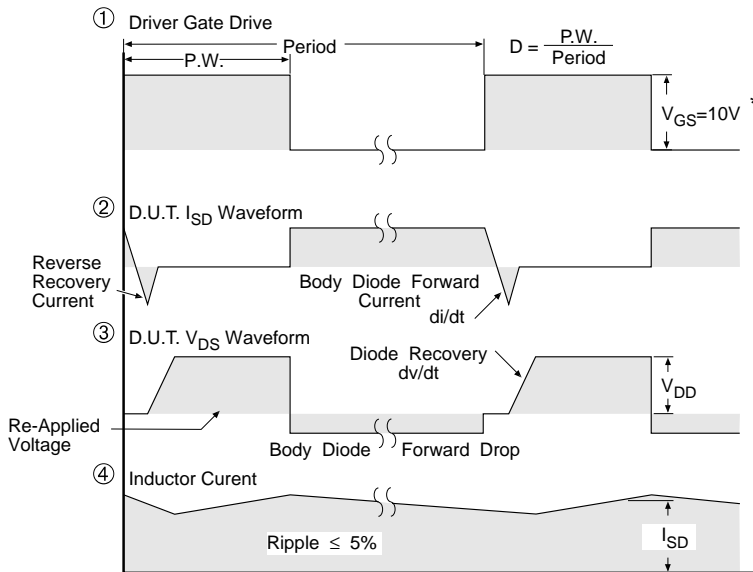
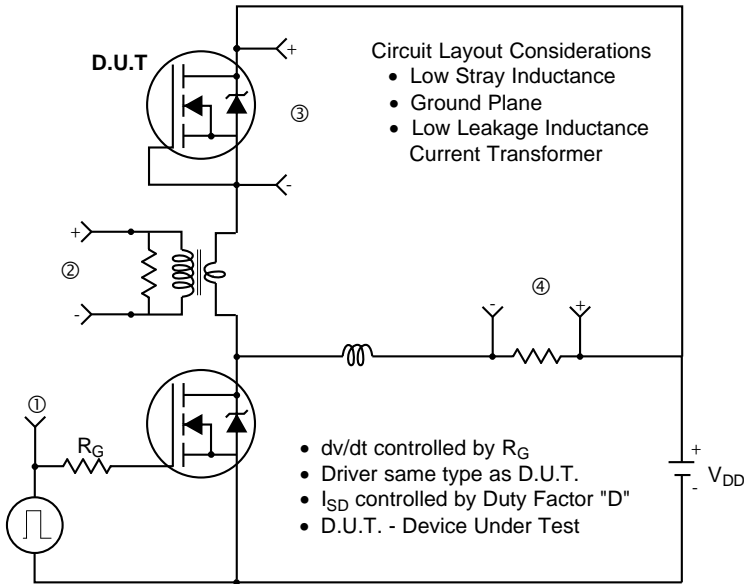


**Fig 12c.** Maximum Avalanche Energy Vs. Drain Current



**Fig 13b.** Gate Charge Test Circuit

### Peak Diode Recovery dv/dt Test Circuit



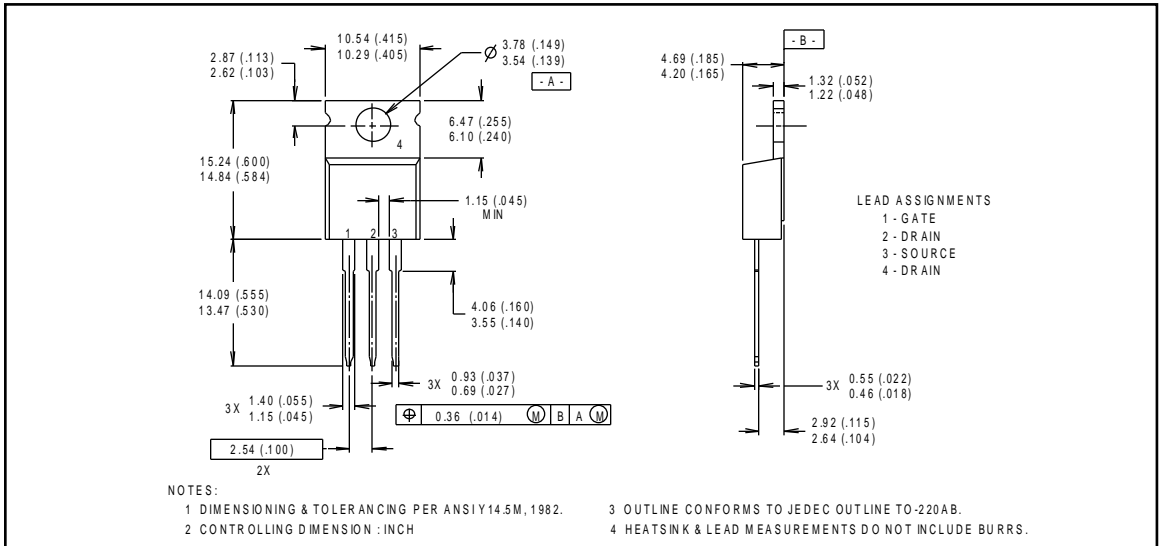
\*  $V_{GS} = 5V$  for Logic Level Devices

**Fig 14.** For N-Channel HEXFETS

## Package Outline

### TO-220AB Outline

Dimensions are shown in millimeters (inches)



## Part Marking Information

### TO-220AB

EXAMPLE : THIS IS AN IRF1010  
 WITH ASSEMBLY  
 LOT CODE 9B1M

