

MULTIFUNCTION VOLTAGE REGULATOR FOR CAR RADIO

- 3 OUTPUTS:
10V (500mA); 5V (1A); 5V (100mA) STANDBY
- OUT1 (10V) AND OUT2 (5V) WITH INDEPENDENT ENABLE CONTROL FOR STANDBY MODE
- 3A HIGH SIDE DRIVER WITH CLAMPED OUTPUT (16V)
- LOGIC OUTPUT FOR:
 - SUPPLY UNDERVOLTAGE (LVW)
 - OVERVOLTAGE
 - THERMAL PROTECTION
- RESET FUNCTION
- IGNITION COMPARATOR
- REVERSE BATTERY AND LOAD DUMP PROTECTION
- THERMAL SHUTDOWN

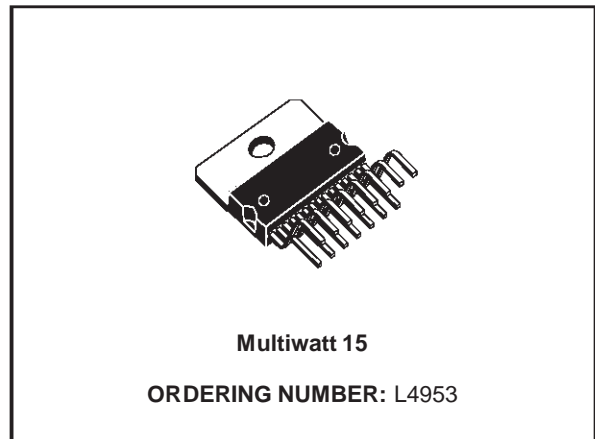

DESCRIPTION

The L4953 contains a triple voltage regulator and a power switch.

The IC includes a monitoring circuit to warn if a

low voltage or no voltage condition is occurring.

In stand-by output is active as long as possible even when in thermal shutdown or any other fault conditions.

The STCAP pin allows the use of a reserve supply capacitor that will hold enough energy for the 5V Stand-by line to allow the μ P to store data.

BLOCK DIAGRAM

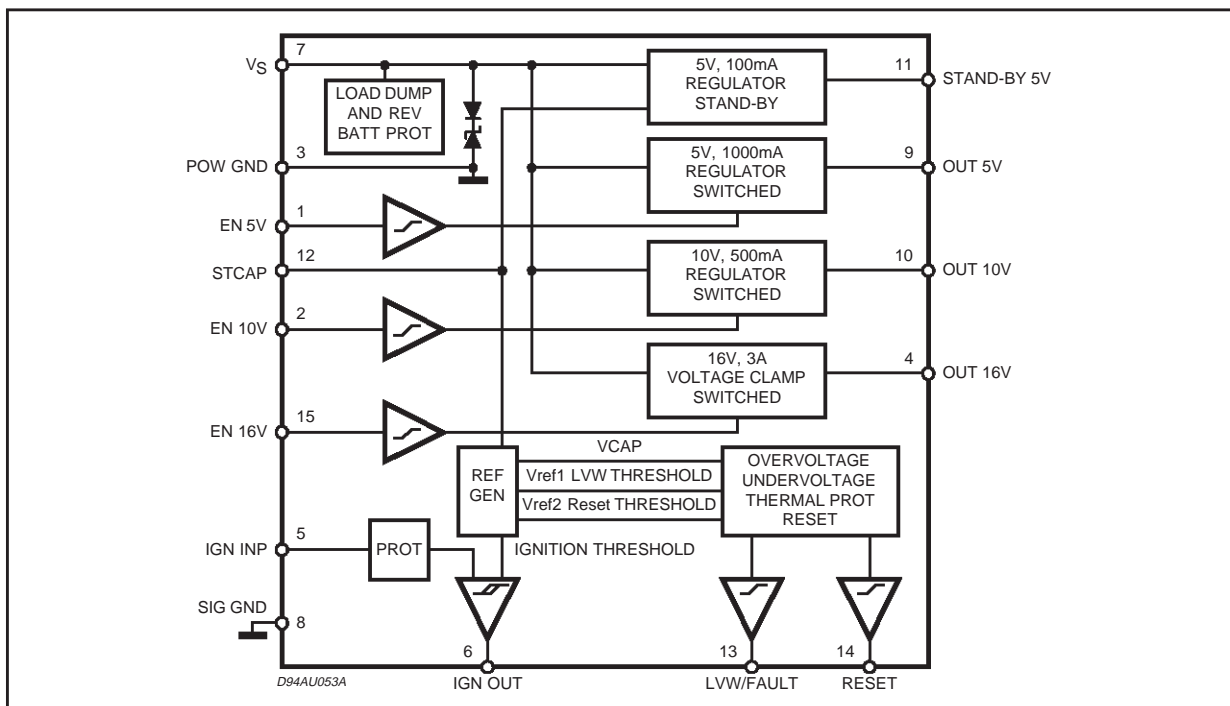

ABSOLUTE MAXIMUM RATINGS

Symbol	Parameter	Value	Unit
V _{SDC}	DC Operating Supply Voltage	-14 to 28	V
V _{STR}	Transient Supply Voltage	50	V
I _o	Output Current	internally limited	
T _{op}	Operating Temperature Range	-40 to 85	°C
T _{stg}	Storage Temperature	-55 to 150	°C

PIN CONNECTION (Top view)

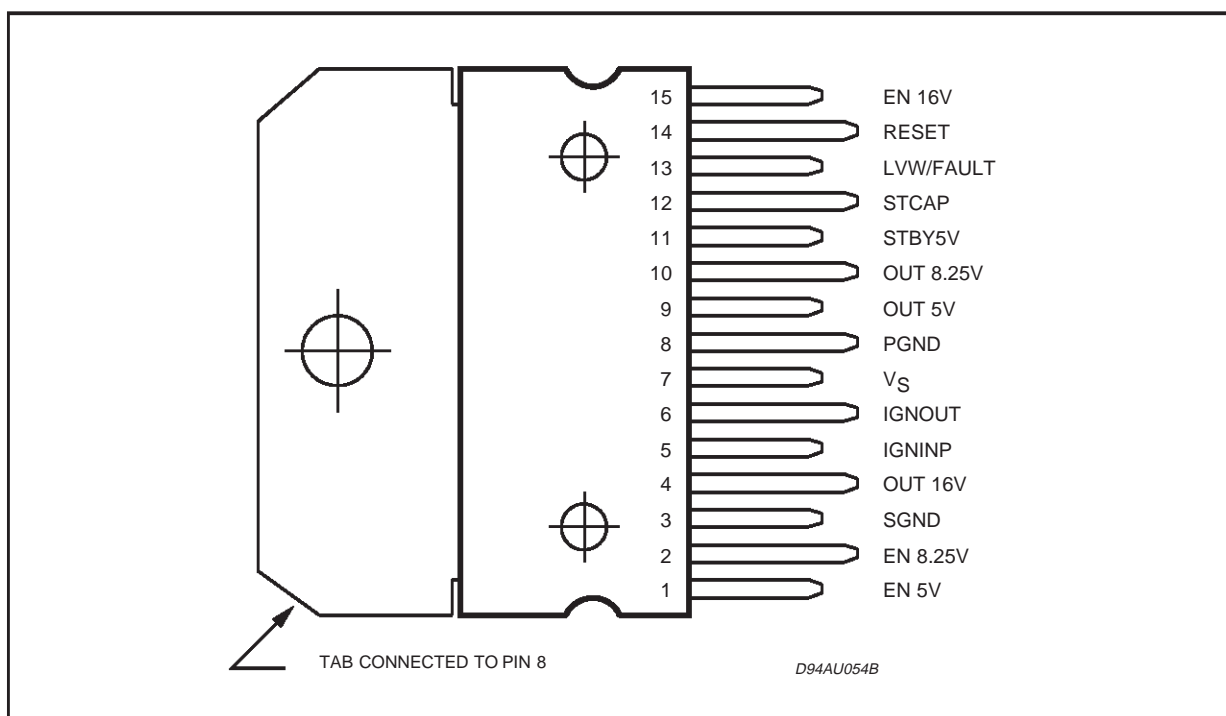

THERMAL DATA

Symbol	Parameter	Value	Unit
R _{th j-case}	Thermal Resistance Junction-case	2	°C/W

ELECTRICAL CHARACTERISTICS ($V_S = 14V$, $T_{amb} = 25^\circ C$, unless otherwise specified.)

Symbol	Parameter	Test Condition	Min.	Typ.	Max.	Unit
V_S	Operating Supply Voltage		11		18	V
E_n	Output Noise Voltage	Any reg. supply, $f = 100\text{Hz to } 200\text{KHz}$		200	400	μV

5V STAND-BY OUTPUT VOLTAGE

$V_{5\text{st-by}}$	Stand-by Output Voltage	No load	4.75	5	5.25	V
ΔV_{line}	Line Regulation	$11V < V_S < 16V$		5	50	mV
ΔV_{load}	Load Regulation	$5\text{mA} < I_O < 100\text{mA}$		45	150	mV
V_{dropout}	Dropout Voltage	$I_{\text{out}} = 100\text{mA}$ $V_S = 5.5V$		0.2	0.6	V
$I_{\text{qst-by}}$	Quiescent Current @ Stand-by	$I_L = 5\text{mA}$		0.3	0.65	mA

5V/100mA SWITCHED OUTPUT VOLTAGE

$V_{\text{out}5}$	5V Output Voltage	no load	4.75	5	5.25	V
ΔV_{line}	Line Regulation	$7V < V_S < 18V$		5	50	mV
ΔV_{load}	Load Regulation	$5\text{mA} < I_O < 1A$		12	50	mV
V_{dropout}	Dropout Voltage	$I_O = 1A$ $V_S = 5.5V$		1	1.5	V
I_q	Quiescent Current	$I_O = 1A$		30	100	mA
I_{lim}	Current Limit	Output Shorted to GND	1	1.3		A
SWon	Switch ON		3.5			V
SW off	Switch OFF				1.5	V
SW hyst	Switch Hysteresis		100	200	500	mV
R_{in}	Input Impedance		10	40		K Ω

10V/500mA SWITCHED OUTPUT VOLTAGE

$V_{\text{out}10}$	10V Output Voltage	no load	9.5	10	10.5	V
ΔV_{line}	Line Regulation	$11V < V_S < 18V$		5	50	mV
ΔV_{load}	Load Regulation	$5\text{mA} < I_O < 500\text{mA}$		12	50	mV
V_{dropout}	Dropout Voltage	$5.5V < V_S < 10V$ $I_O = 500\text{mA}$		0.4	0.9	V
I_q	Quiescent Current	$I_O = 500\text{mA}$		10	50	mA
I_{lim}	Current Limit	Output Shorted to GND	500	600		mA
SVR	Supply Voltage Rejection	$f = 3\text{KHz}$	45			dB
SWon	Switch ON		3.5			V
SW off	Switch OFF				1.5	V
SW hyst	Switch Hysteresis		100	200	500	mV
R_{in}	Input Impedance		10	40		K Ω

HIGH SIDE DRIVER WITH CLAMPED OUTPUT (16V)

$V_{\text{out}16}$	Max. Output Voltage	$V_S = 18V$	14.6		16.2	V
I_O	Output Continuous Current	$V_S = 16V$	2			A
V_{dropout}	Dropout Voltage	$6V < V_{\text{in}} < 15V$ $I_O = 1A$		0.4	0.9	V
SWon	Switch ON		3.5			V
SW off	Switch OFF				1.5	V
SW hyst	Switch Hysteresis		100	200	500	mV
R_{in}	Input Impedance		10	40		K Ω

ELECTRICAL CHARACTERISTICS (continued)

FAULT

Symbol	Parameter	Test Condition	Min.	Typ.	Max.	Unit
TH _{fault}	Fault Threshold		7		8.5	V
HYST _{fault}	Fault Threshold Hysteresis		100	200	300	mV
OUT _{fault}	Fault Output Voltage				1.5	V
I _{leak}	Fault Leakage Current				50	μA

RESET

THON _{reset}	Reset ON Threshold		4.5		5.15	V
HYST _{reset}	Reset Threshold Hysteresis		75	175	300	mV
OUT _{reset}	Reset Output Voltage				1.5	V
I _{leak}	Reset Leakage Current				5	μA

IGNITION

TH _{ign}	Ign Comparator Positive Threshold		5.5	6	7.5	V
HYST _{ign}	Ign Comparator Threshold Hysteresis		100	300	500	mV
IGN _{high}	Ignition Comparator Output High		3.5		V _{st-by}	V
IGN _{low}	Ignition Comparator Output Low		-0.5		1.5	V

DIM.	mm			inch		
	MIN.	TYP.	MAX.	MIN.	TYP.	MAX.
A			5			0.197
B			2.65			0.104
C			1.6			0.063
D		1			0.039	
E	0.49		0.55	0.019		0.022
F	0.66		0.75	0.026		0.030
G	1.02	1.27	1.52	0.040	0.050	0.060
G1	17.53	17.78	18.03	0.690	0.700	0.710
H1	19.6			0.772		
H2			20.2			0.795
L	21.9	22.2	22.5	0.862	0.874	0.886
L1	21.7	22.1	22.5	0.854	0.870	0.886
L2	17.65		18.1	0.695		0.713
L3	17.25	17.5	17.75	0.679	0.689	0.699
L4	10.3	10.7	10.9	0.406	0.421	0.429
L7	2.65		2.9	0.104		0.114
M	4.25	4.55	4.85	0.167	0.179	0.191
M1	4.63	5.08	5.53	0.182	0.200	0.218
S	1.9		2.6	0.075		0.102
S1	1.9		2.6	0.075		0.102
Dia1	3.65		3.85	0.144		0.152

OUTLINE AND MECHANICAL DATA

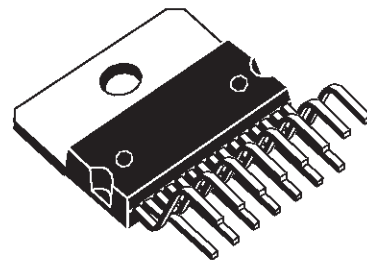

Multiwatt15 V

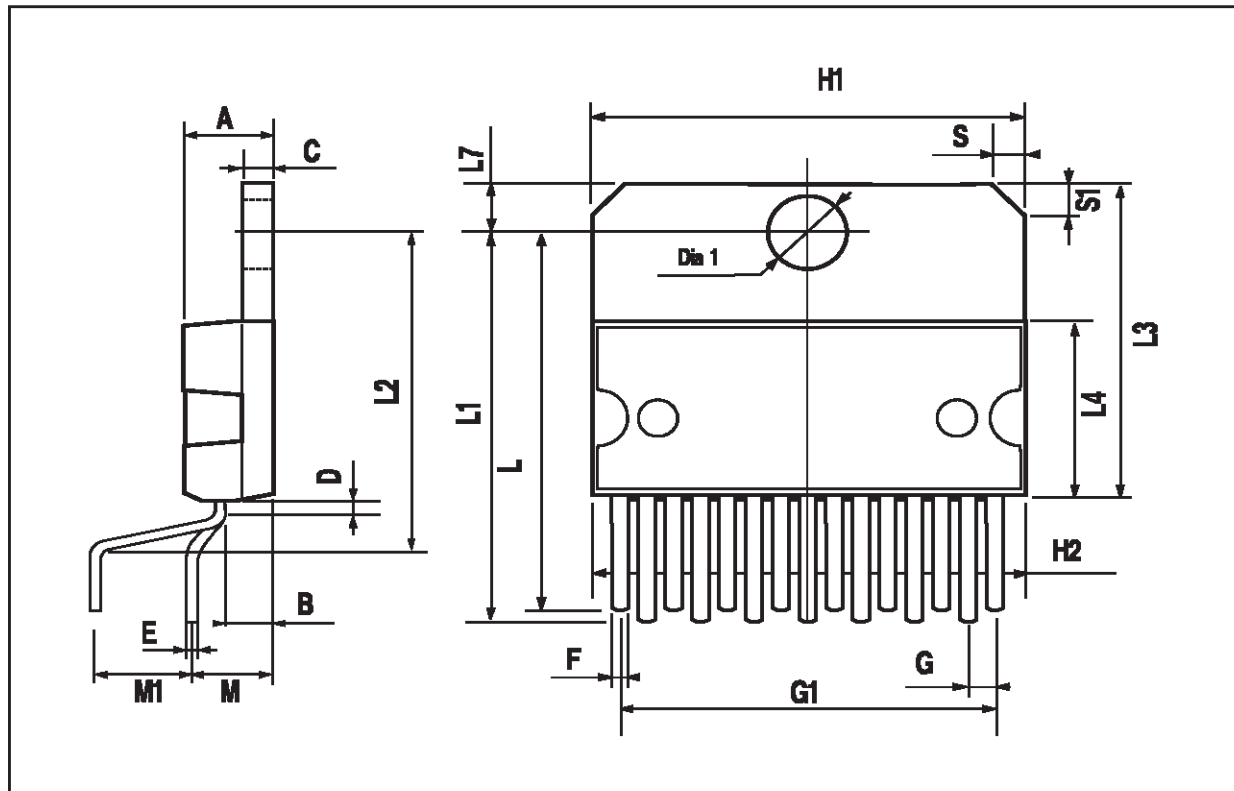

Information furnished is believed to be accurate and reliable. However, STMicroelectronics assumes no responsibility for the consequences of use of such information nor for any infringement of patents or other rights of third parties which may result from its use. No license is granted by implication or otherwise under any patent or patent rights of STMicroelectronics. Specification mentioned in this publication are subject to change without notice. This publication supersedes and replaces all information previously supplied. STMicroelectronics products are not authorized for use as critical components in life support devices or systems without express written approval of STMicroelectronics.

The ST logo is a registered trademark of STMicroelectronics

© 2000 STMicroelectronics – Printed in Italy – All Rights Reserved

STMicroelectronics GROUP OF COMPANIES

Australia - Brazil - China - Finland - France - Germany - Hong Kong - India - Italy - Japan - Malaysia - Malta - Morocco -
Singapore - Spain - Sweden - Switzerland - United Kingdom - U.S.A.

<http://www.st.com>