



LM321

Single Rail-to-Rail Output Operational Amplifier

GENERAL DESCRIPTION

The LM321 is a single high-gain frequency-compensated operational amplifier, which can operate from 3V to 32V single supply or from $\pm 1.5V$ to $\pm 16V$ dual supplies while consuming only 240 μA quiescent current.

The LM321 features low power, low offset voltage and low bias current. It is well suited for a wide range of applications.

The LM321 is available in a Green SOT-23-5 package. It is specified over the 0°C to +70°C temperature range.

APPLICATIONS

Wearable Products
Temperature Measurements
Battery-Powered Systems
Sensors
Audio
Active Filters
Communications
Test Equipment

FEATURES

- **Wide Supply Ranges**
 - Single Supply: 3V to 32V
 - Dual Supplies: $\pm 1.5V$ to $\pm 16V$
- **Low Quiescent Current: 240 μA (TYP)**
- **Low Input Offset Voltage: 5.8mV (MAX)**
- **Low Input Offset Current: 20pA (TYP)**
- **Low Input Bias Current: 10pA (TYP)**
- **Minimum Input Common Mode Voltage: $(-V_S) - 0.1V$**
- **Maximum Differential Input Voltage: +32V/-32V**
- **Gain-Bandwidth Product: 1.1MHz**
- **Open-Loop Differential Voltage Gain: 111dB (TYP)**
- **Internal Frequency Compensation**
- **0°C to +70°C Operating Temperature Range**
- **Available in a Green SOT-23-5 Package**

LM321

PACKAGE/ORDERING INFORMATION

| MODEL | PACKAGE DESCRIPTION | SPECIFIED TEMPERATURE RANGE | ORDERING NUMBER | PACKAGE MARKING | PACKING OPTION |
|-------|---------------------|-----------------------------|-----------------|-----------------|---------------------|
| LM321 | SOT-23-5 | 0°C to +70°C | LM321ZN5G/TR | MX0XX | Tape and Reel, 3000 |

MARKING INFORMATION

NOTE: XX = Date Code.

YYY X X

└── Date Code - Week

└── Date Code - Year

└── Serial Number

Green (RoHS & HSF): SG Micro Corp defines "Green" to mean Pb-Free (RoHS compatible) and free of halogen substances. If you have additional comments or questions, please contact your SGMICRO representative directly.

ABSOLUTE MAXIMUM RATINGS

| | |
|--|-----------------|
| Supply Voltage, V_S | -0.3V to 32V |
| Differential Input Voltage, $V_{ID}^{(1)}$ | -32V to 32V |
| Input Voltage (Either Input) | -0.3V to 32V |
| Junction Temperature..... | +150°C |
| Storage Temperature Range..... | -65°C to +150°C |
| Lead Temperature (Soldering, 10s)..... | +260°C |
| ESD Susceptibility | |
| HBM..... | 6000V |
| CDM | 1000V |

RECOMMENDED OPERATING CONDITIONS

| | |
|--------------------------------------|-----------------------|
| Input Common Mode Voltage Range..... | -0.1V to $V_S - 1.5V$ |
| Operating Temperature Range..... | 0°C to +70°C |

NOTE:

1. Differential voltage is between +IN and -IN.

OVERSTRESS CAUTION

Stresses beyond those listed in Absolute Maximum Ratings may cause permanent damage to the device. Exposure to absolute maximum rating conditions for extended periods may affect reliability. Functional operation of the device at any conditions beyond those indicated in the Recommended Operating Conditions section is not implied.

ESD SENSITIVITY CAUTION

This integrated circuit can be damaged if ESD protections are not considered carefully. SGMICRO recommends that all integrated circuits be handled with appropriate precautions. Failure to observe proper handling and installation procedures can cause damage. ESD damage can range from subtle performance degradation to complete device failure. Precision integrated circuits may be more susceptible to damage because even small parametric changes could cause the device not to meet the published specifications.

DISCLAIMER

SG Micro Corp reserves the right to make any change in circuit design, or specifications without prior notice.

PIN CONFIGURATION

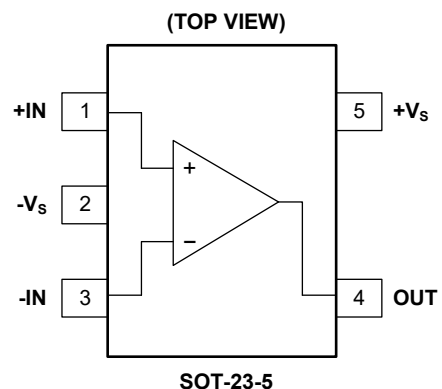

ELECTRICAL CHARACTERISTICS

(At $T_A = +25^\circ\text{C}$, $V_S = 3\text{V}$ to 32V , $R_L = 10\text{k}\Omega$ connected to $V_S/2$, $-0.1\text{V} < V_{CM} < V_S - 1.5\text{V}$, Full = 0°C to $+70^\circ\text{C}$, unless otherwise noted.)

| PARAMETER | SYMBOL | CONDITIONS | TEMP | MIN | TYP | MAX | UNITS |
|--|------------|---|-------|------|------|-------------|------------------------------|
| Input Characteristics | | | | | | | |
| Input Offset Voltage | V_{OS} | | +25°C | | 1.2 | 5.8 | mV |
| | | | Full | | | 6.6 | |
| Input Bias Current | I_B | $V_{CM} = V_S/2$ | +25°C | | 10 | | pA |
| Input Offset Current | I_{OS} | $V_{CM} = V_S/2$ | +25°C | | 20 | | pA |
| Maximum Differential Input Voltage | $ V_{ID} $ | | Full | | | V_S | V |
| Input Common Mode Voltage Range | V_{CM} | | Full | -0.1 | | $V_S - 1.5$ | V |
| Common Mode Rejection Ratio | CMRR | $-0.1\text{V} < V_{CM} < V_S - 1.5\text{V}$ | +25°C | 82 | 118 | | dB |
| | | | Full | 80 | | | |
| Open-Loop Voltage Gain | A_{OL} | $R_L = 10\text{k}\Omega$ to $V_S/2$ | +25°C | 92 | 111 | | dB |
| | | | Full | 90 | | | |
| Output Characteristics | | | | | | | |
| High-Level Output Voltage | V_{OH} | $R_L = 10\text{k}\Omega$ | +25°C | | 42 | 60 | mV |
| | | | Full | | | 70 | |
| Low-Level Output Voltage | V_{OL} | $R_L = 10\text{k}\Omega$ | +25°C | | 110 | 190 | mV |
| | | | Full | | | 210 | |
| Output Short-Circuit Current | I_{SC} | | +25°C | 12 | 18 | | mA |
| Power Supply | | | | | | | |
| Operating Voltage Range | V_S | | Full | 3 | | 32 | V |
| Quiescent Current | I_Q | $I_{OUT} = 0\text{A}$ | +25°C | | 240 | 350 | μA |
| | | | Full | | | 410 | |
| Power Supply Rejection Ratio | PSRR | | +25°C | 102 | 122 | | dB |
| | | | Full | 100 | | | |
| Turn-On Time | | $G = +1$ | +25°C | | 42 | | μs |
| Dynamic Performance ($C_L = 100\text{pF}$) | | | | | | | |
| Gain-Bandwidth Product | GBP | | +25°C | | 1.1 | | MHz |
| Slew Rate | SR | $G = +1$ | +25°C | | 0.35 | | $\text{V}/\mu\text{s}$ |
| Overload Recovery Time | ORT | $V_{IN} \times G > V_S$ | +25°C | | 2.3 | | μs |
| Phase Margin | | | +25°C | | 60 | | ° |
| Noise | | | | | | | |
| Input Voltage Noise | | $f = 0.1\text{Hz}$ to 10Hz | +25°C | | 8.7 | | μV_{P-P} |
| Input Voltage Noise Density | e_n | $f = 1\text{kHz}$ | +25°C | | 36 | | $\text{nV}/\sqrt{\text{Hz}}$ |

TYPICAL PERFORMANCE CHARACTERISTICS

At $T_A = +25^\circ\text{C}$, $V_{CM} = V_S/2$, unless otherwise noted.

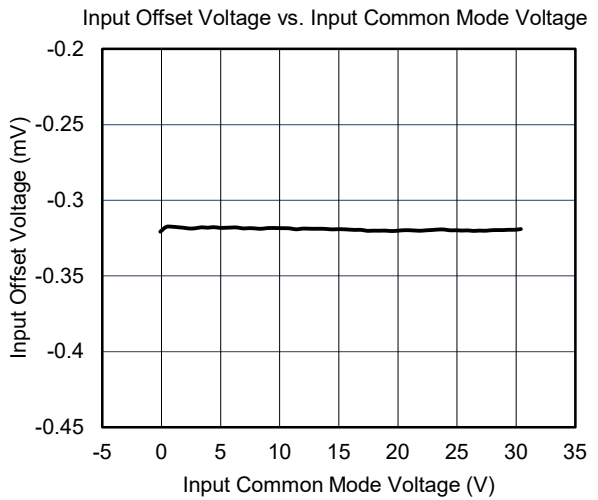
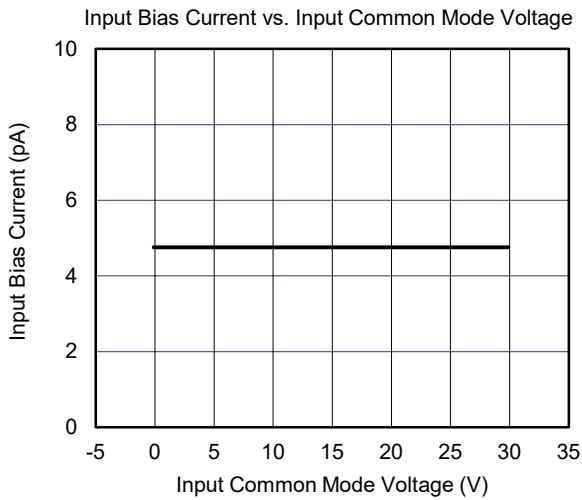
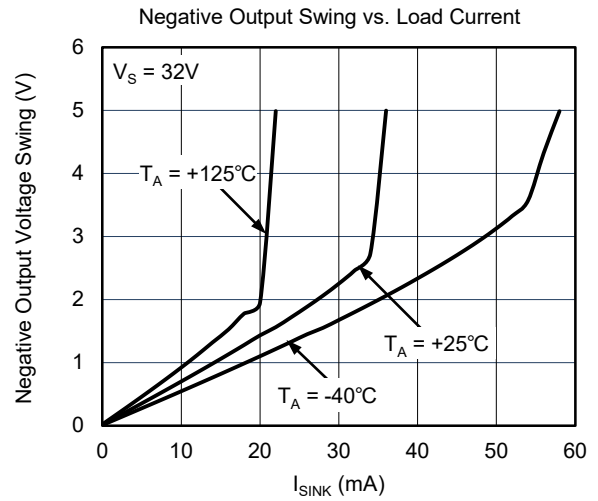
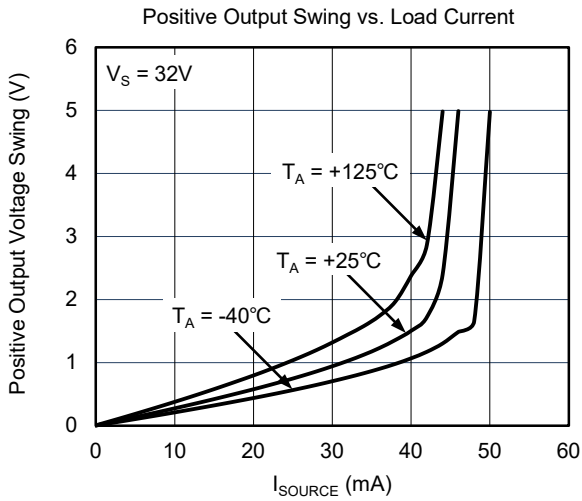
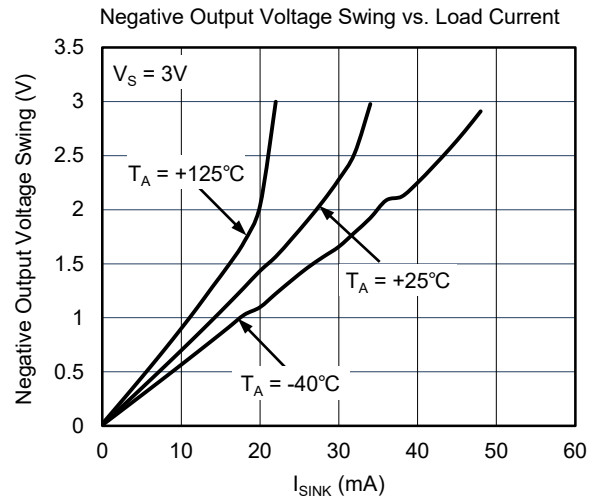
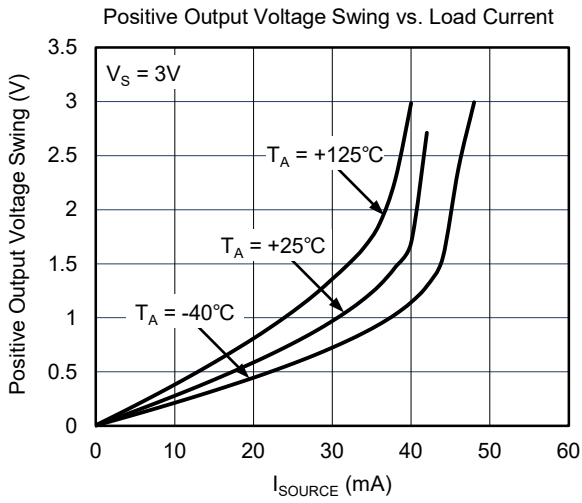

TYPICAL PERFORMANCE CHARACTERISTICS (continued)

At $T_A = +25^\circ\text{C}$, $V_{CM} = V_S/2$, unless otherwise noted.

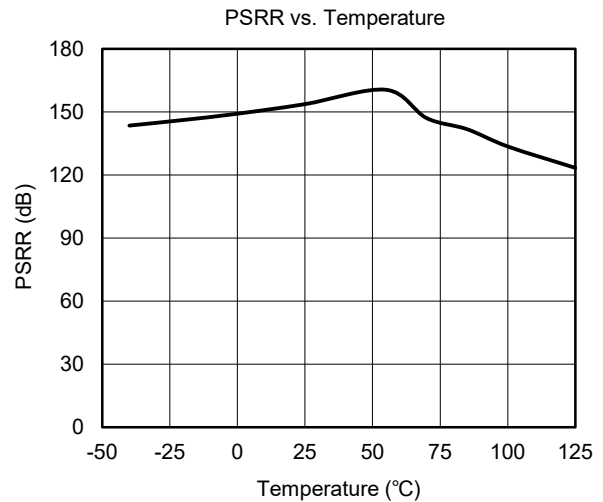
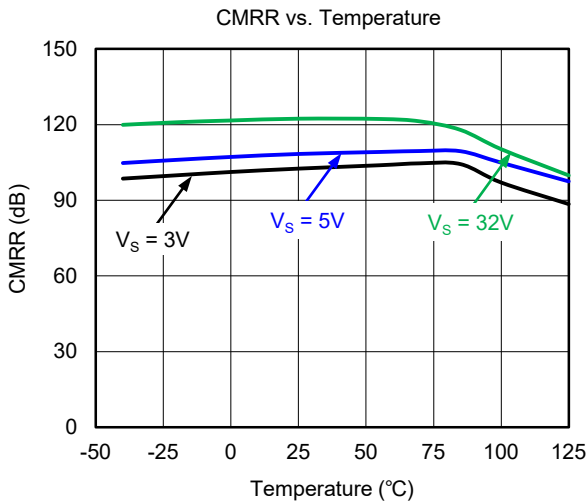
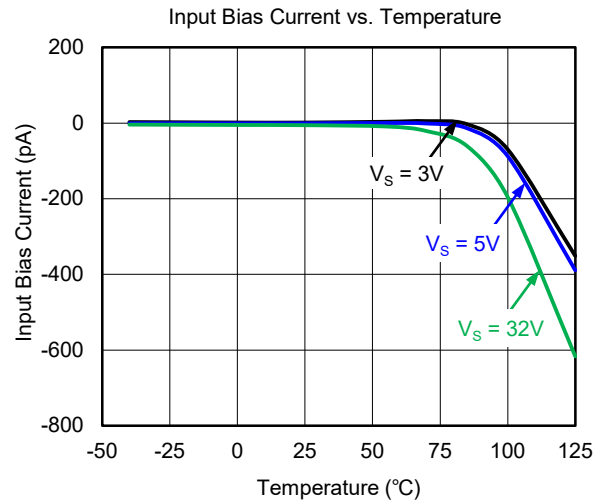
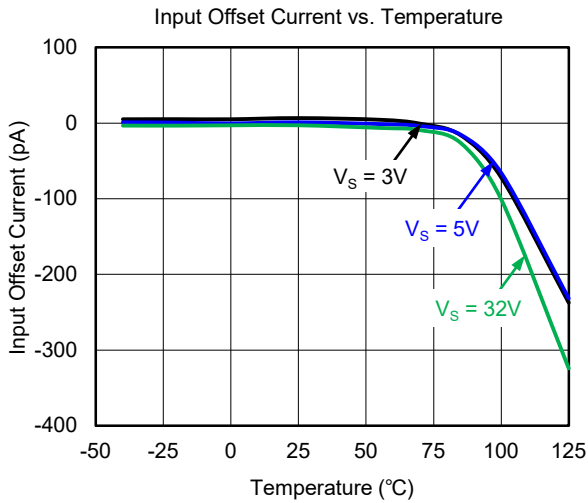
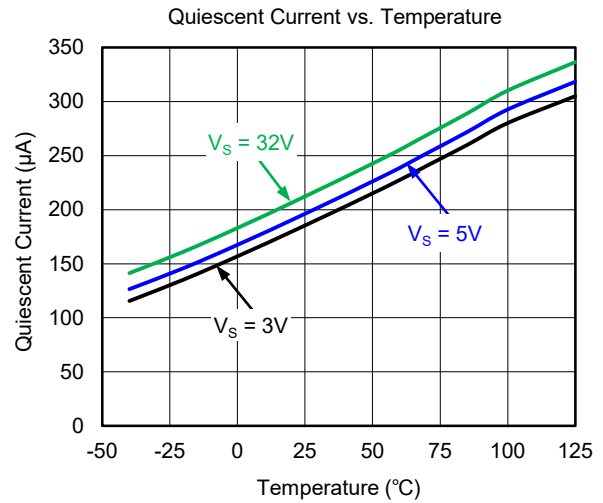
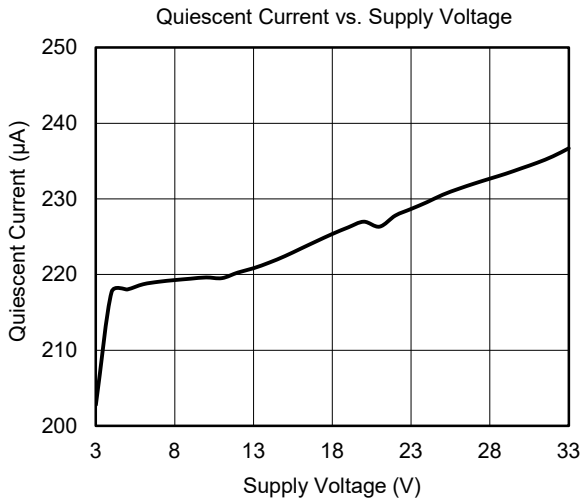

TYPICAL PERFORMANCE CHARACTERISTICS (continued)

At $T_A = +25^\circ\text{C}$, $V_{CM} = V_S/2$, unless otherwise noted.

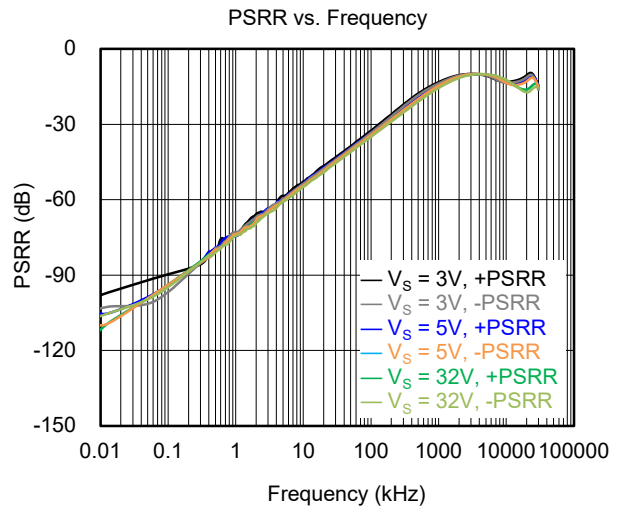
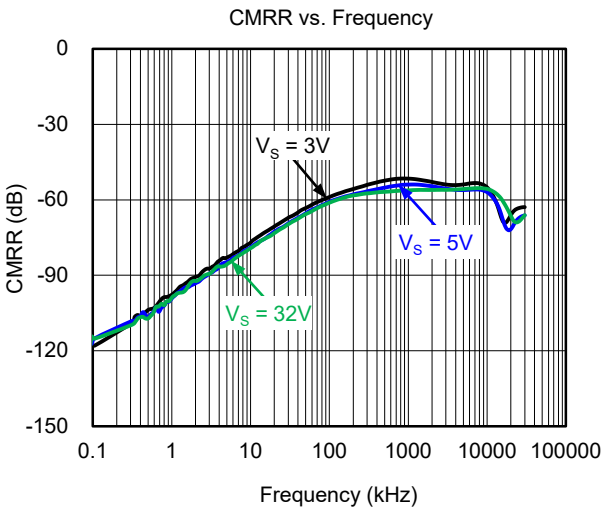
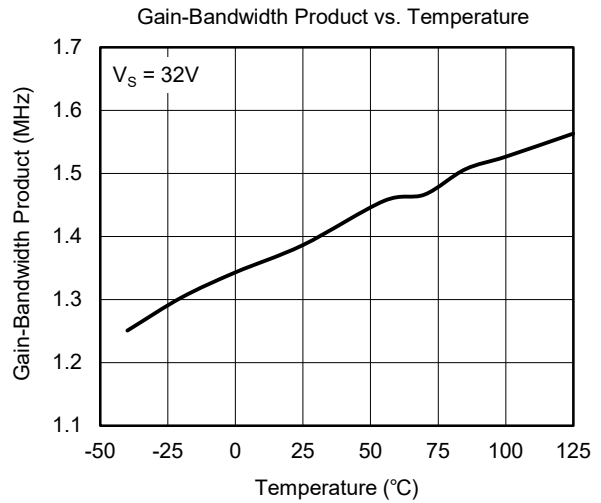
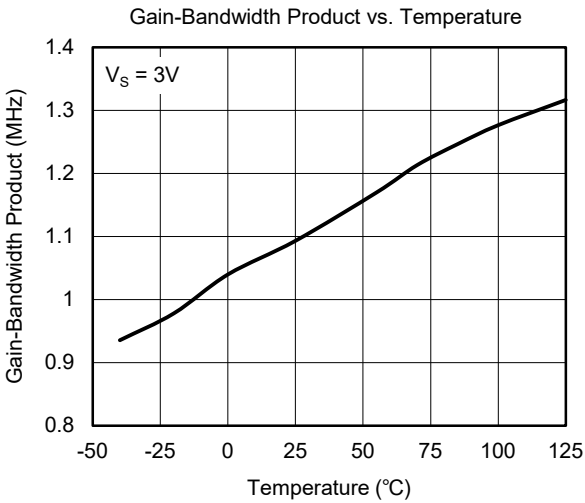
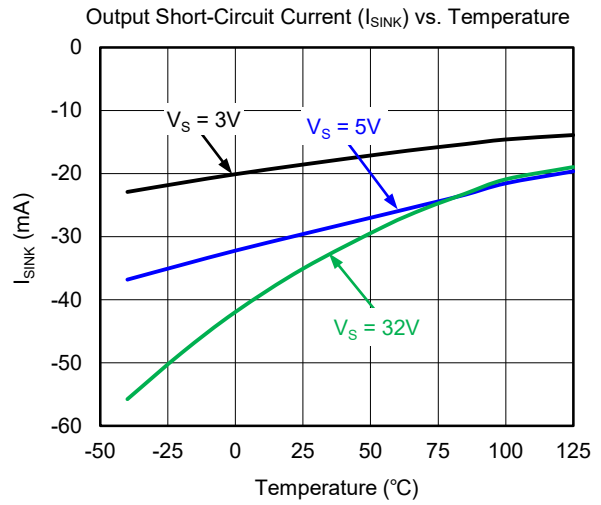
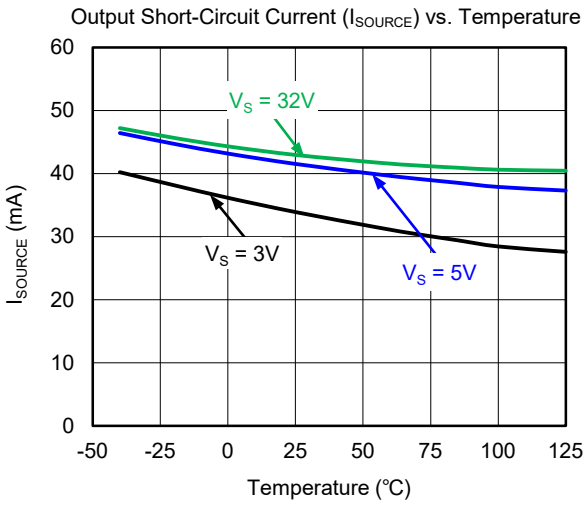

TYPICAL PERFORMANCE CHARACTERISTICS (continued)

At $T_A = +25^\circ\text{C}$, $V_{CM} = V_S/2$, unless otherwise noted.

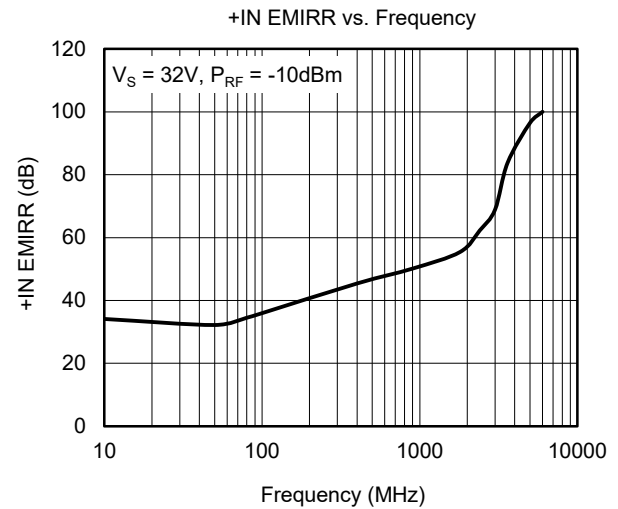
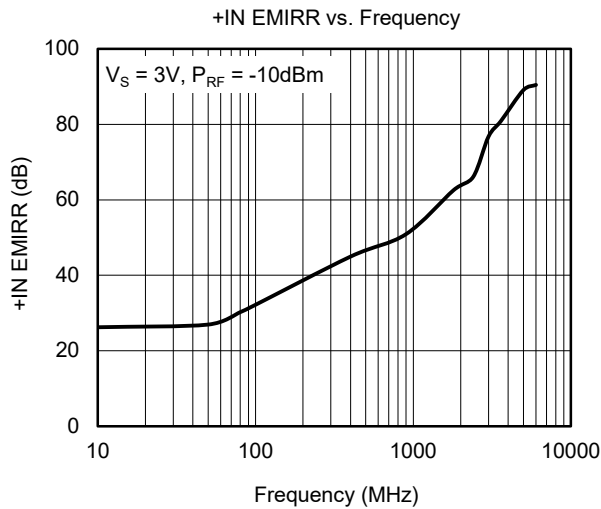
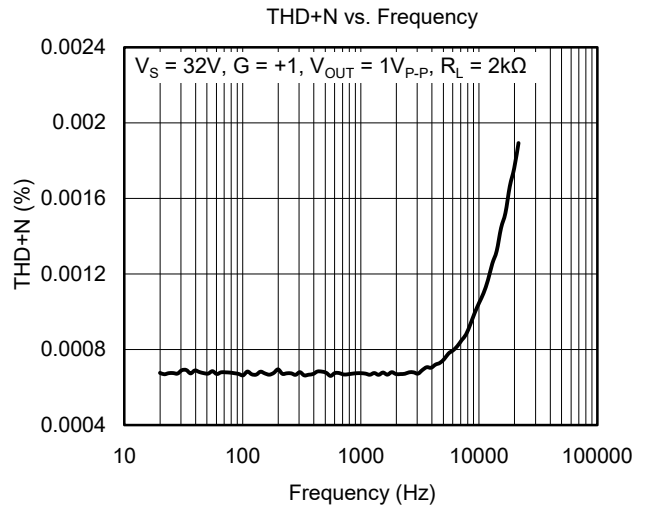
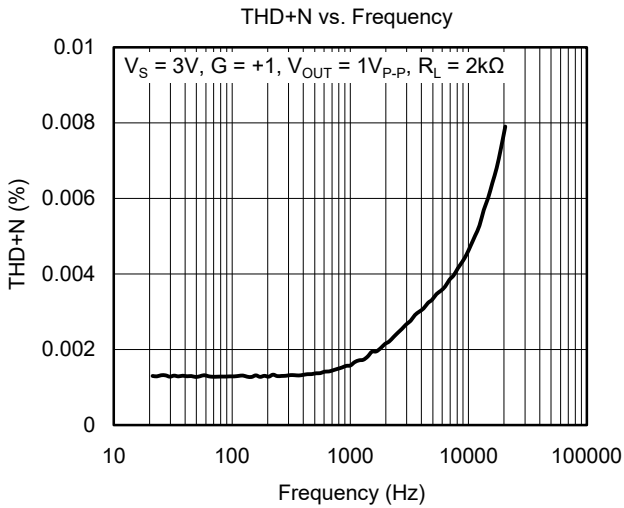
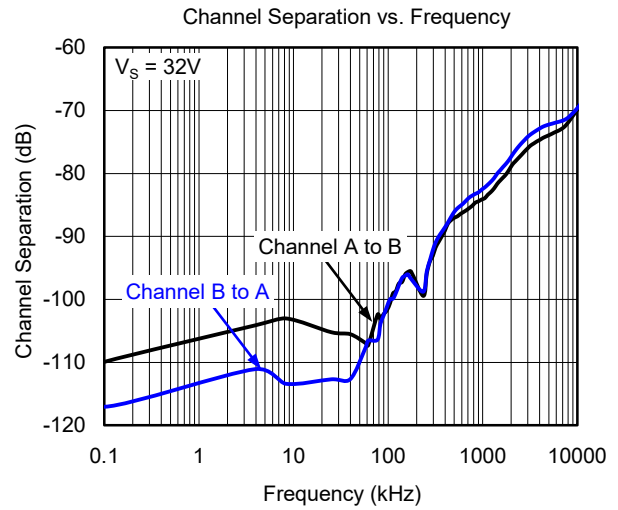
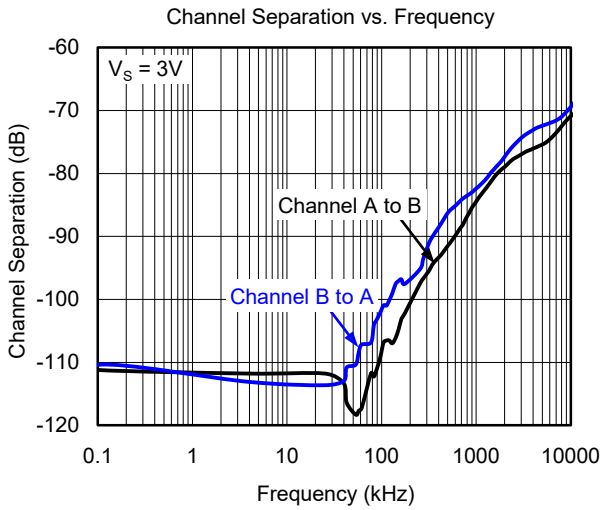

TYPICAL PERFORMANCE CHARACTERISTICS (continued)

At $T_A = +25^\circ\text{C}$, $V_{CM} = V_S/2$, unless otherwise noted.

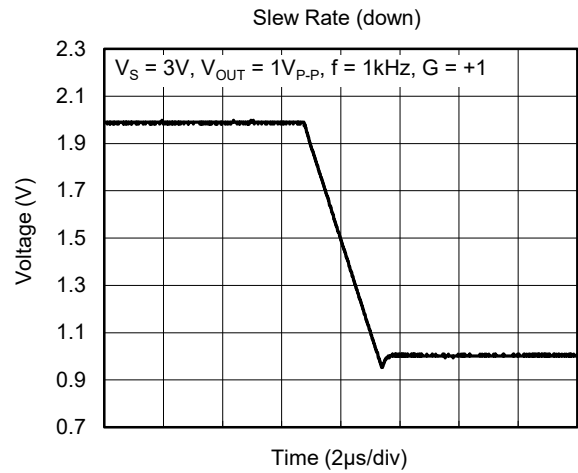
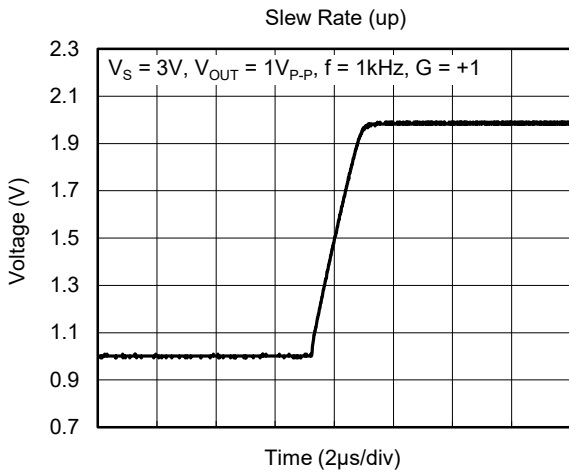
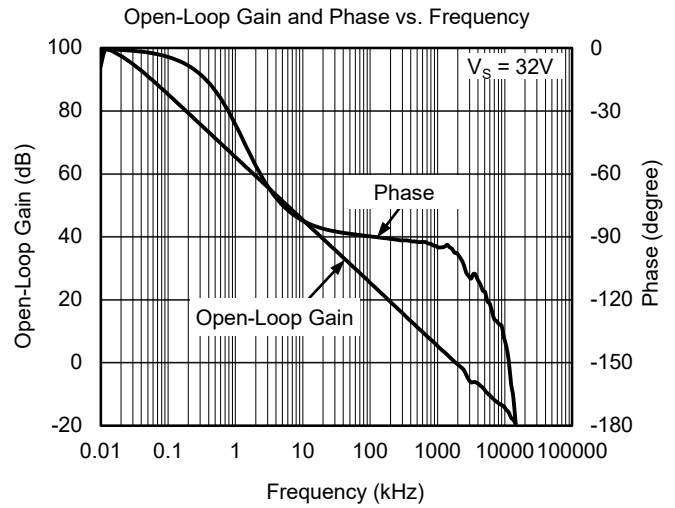
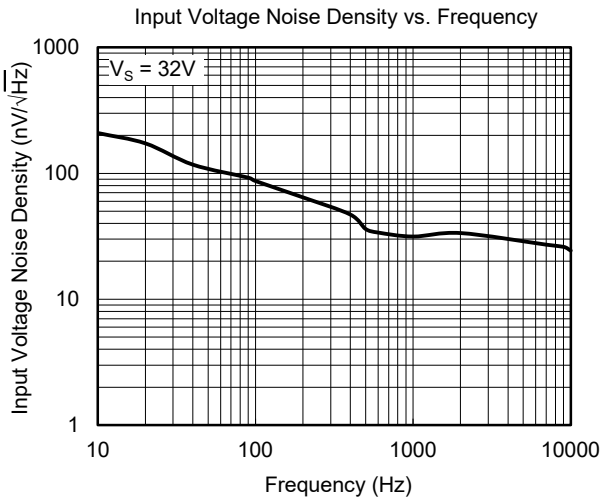
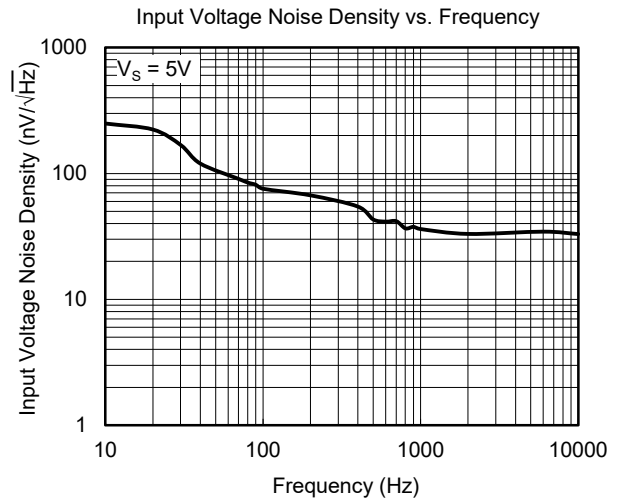
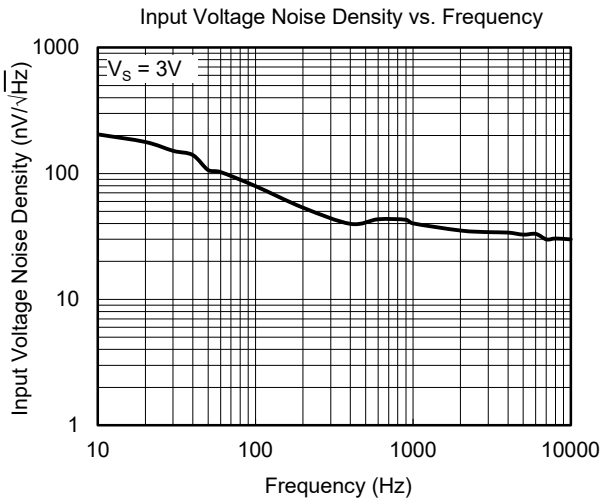

TYPICAL PERFORMANCE CHARACTERISTICS (continued)

At $T_A = +25^\circ\text{C}$, $V_{CM} = V_S/2$, unless otherwise noted.

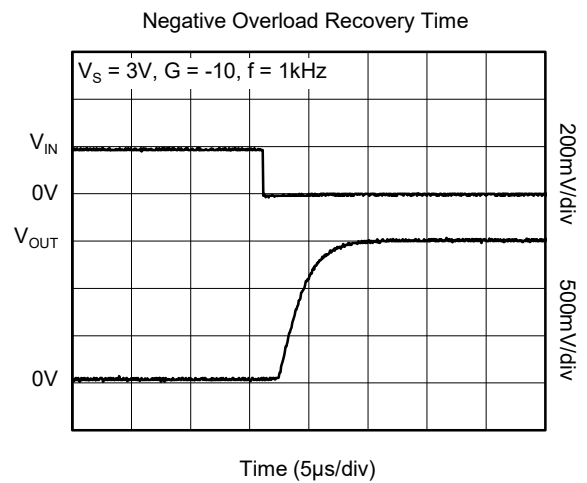
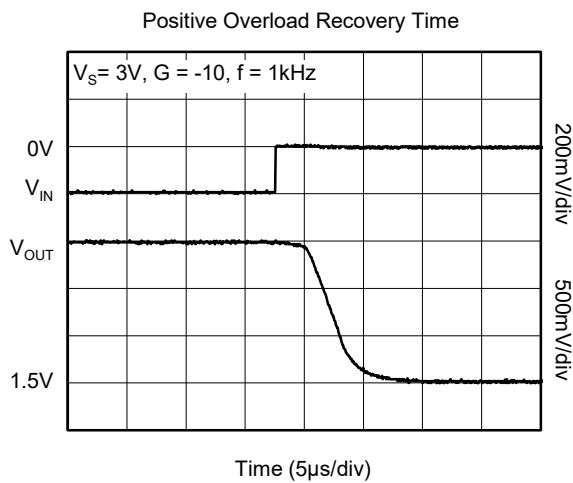
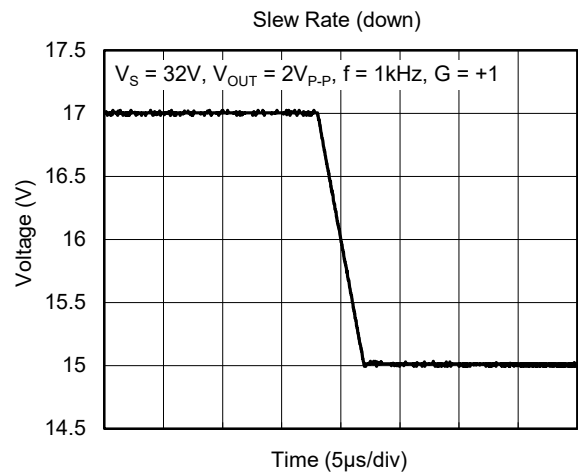
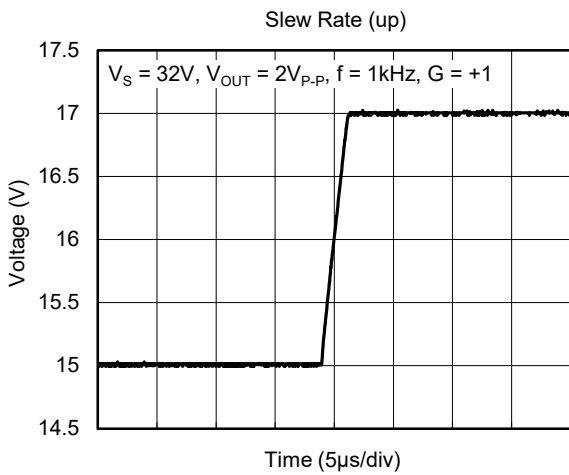
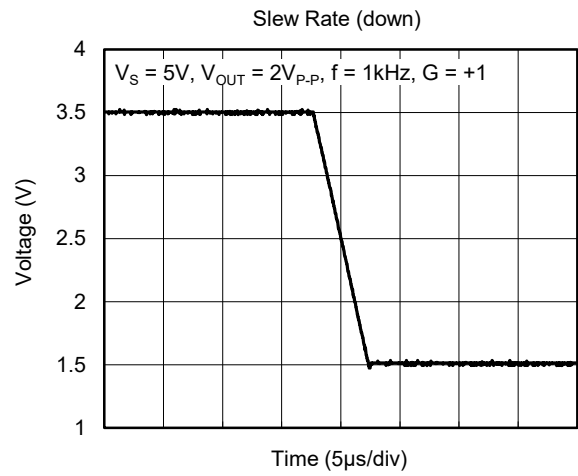
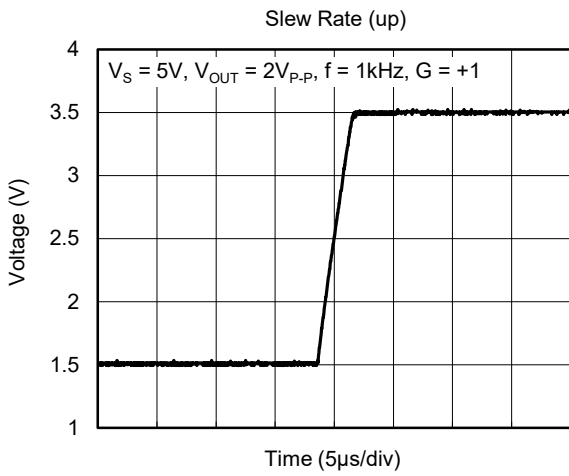

TYPICAL PERFORMANCE CHARACTERISTICS (continued)

At $T_A = +25^\circ\text{C}$, $V_{CM} = V_S/2$, unless otherwise noted.

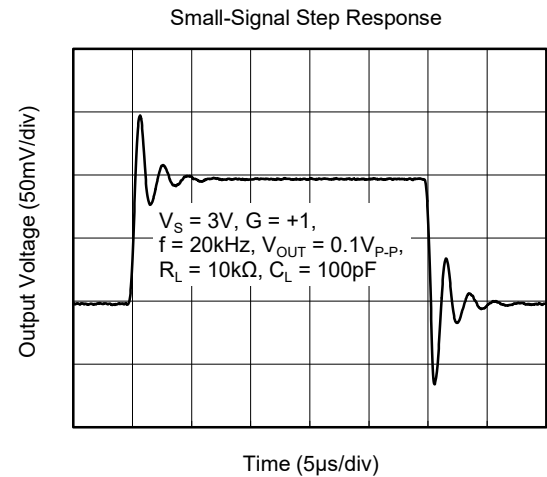
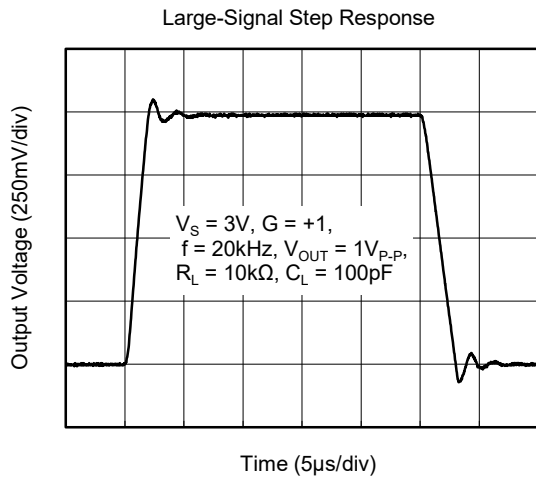
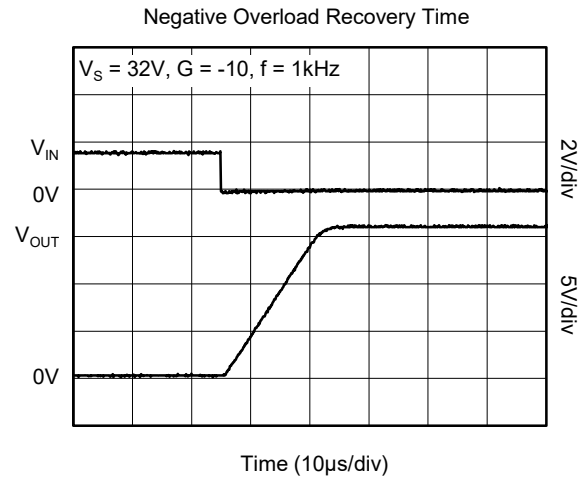
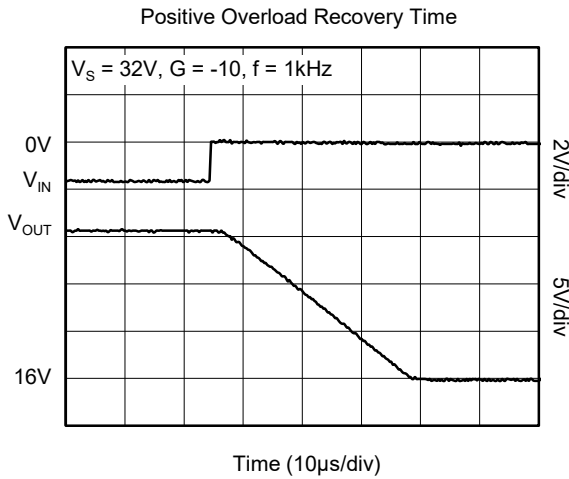
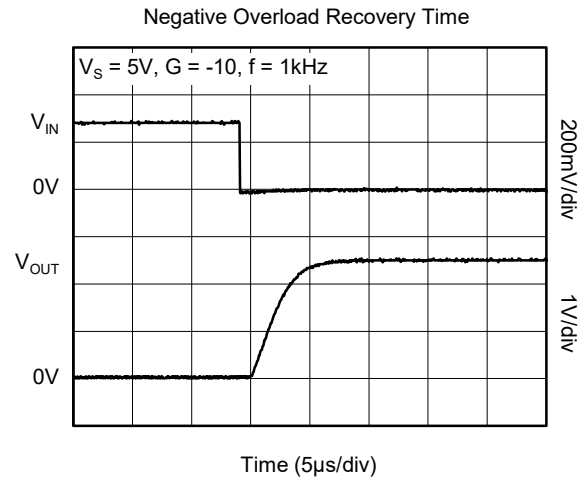
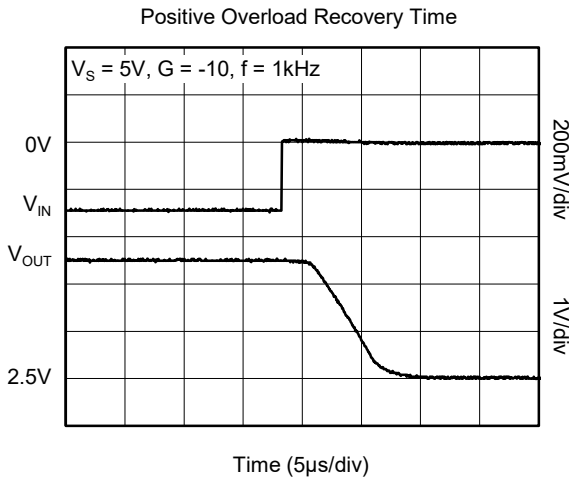

TYPICAL PERFORMANCE CHARACTERISTICS (continued)

At $T_A = +25^\circ\text{C}$, $V_{CM} = V_S/2$, unless otherwise noted.

Large-Signal Step Response

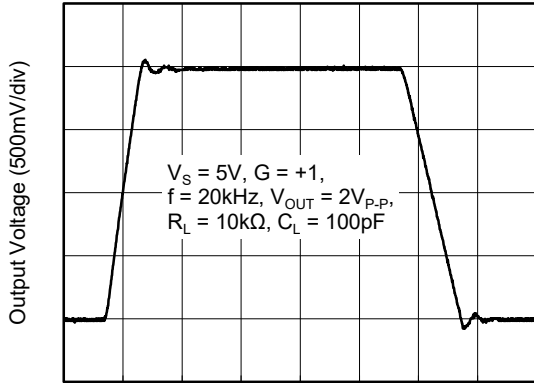

Time (5µs/div)

Small-Signal Step Response

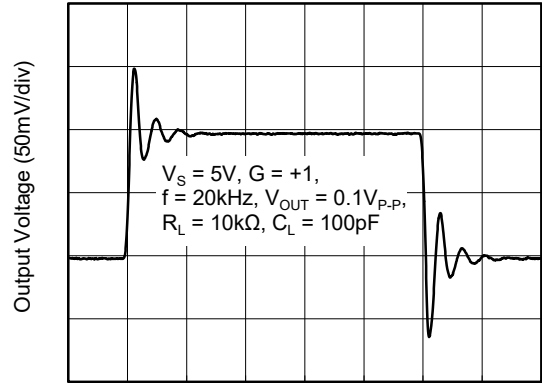

Time (5µs/div)

Large-Signal Step Response

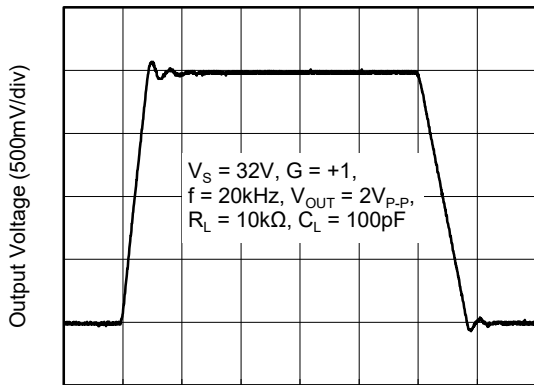

Time (5µs/div)

Small-Signal Step Response

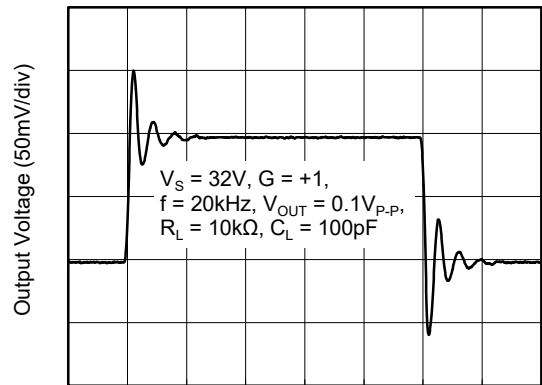

Time (5µs/div)

Turn-On Time

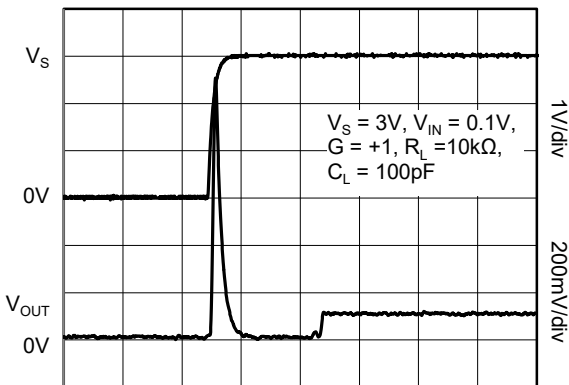

Time (20µs/div)

Turn-On Time

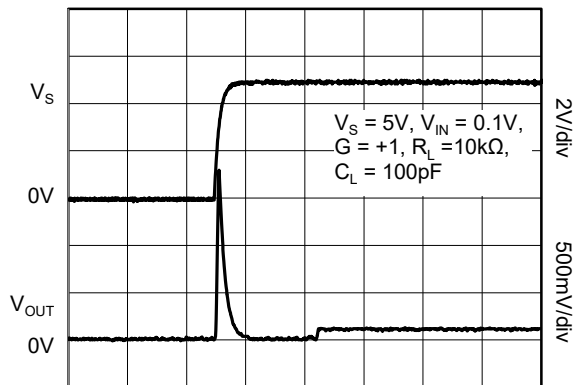

Time (20µs/div)

TYPICAL PERFORMANCE CHARACTERISTICS (continued)

At $T_A = +25^\circ\text{C}$, $V_{CM} = V_S/2$, unless otherwise noted.

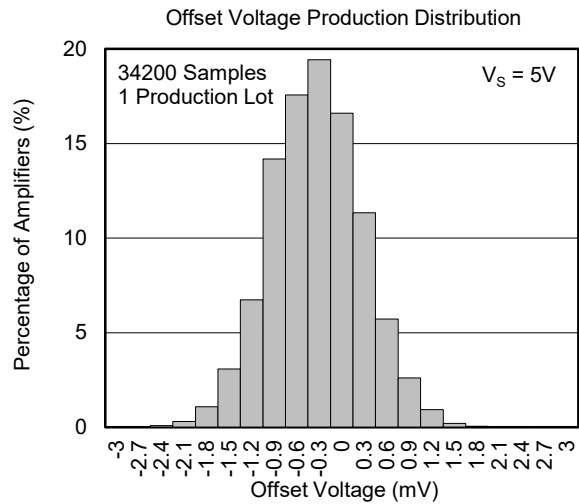
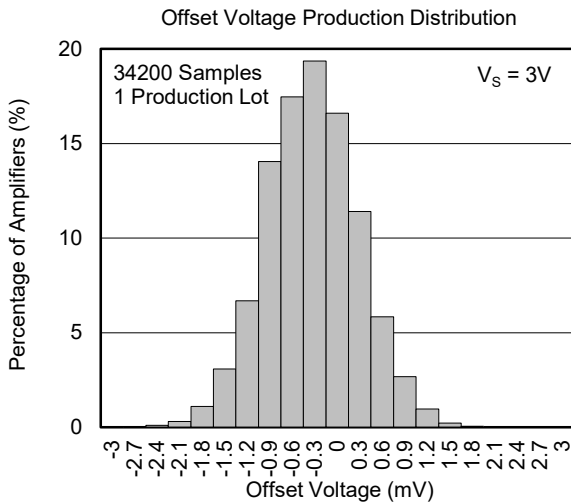
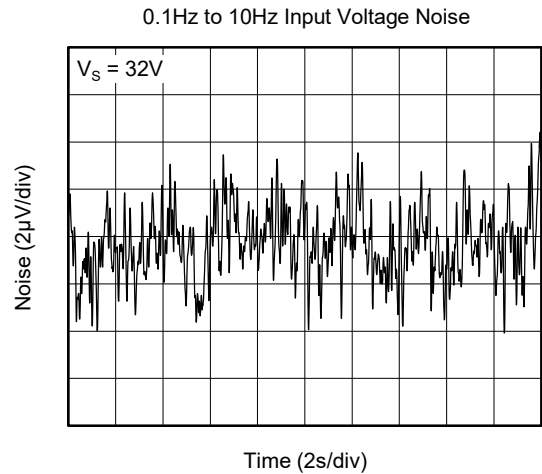
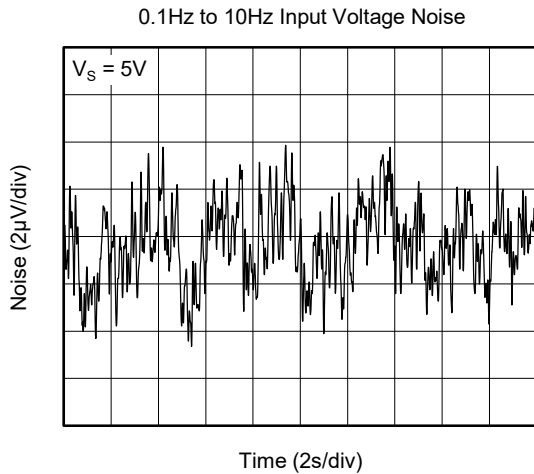
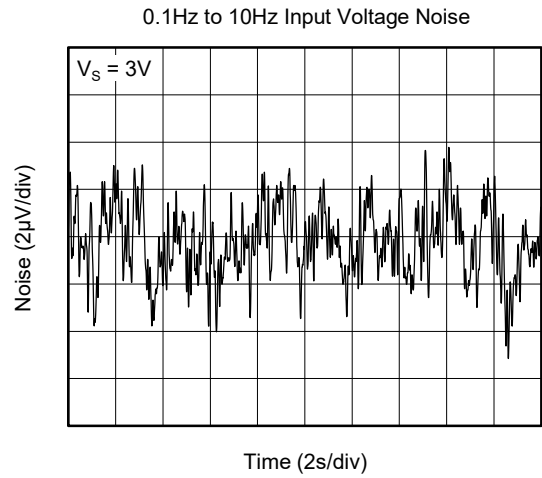
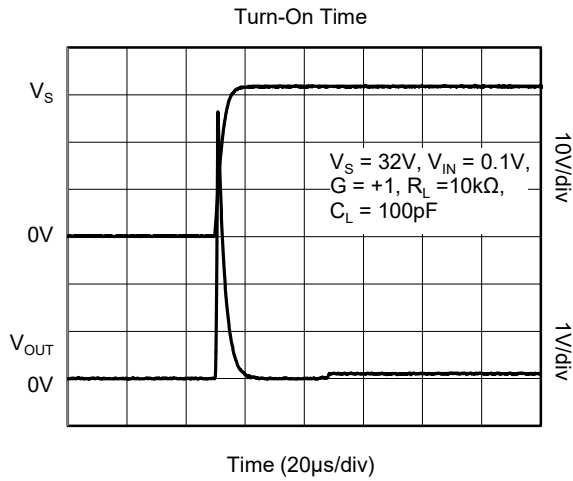

TYPICAL PERFORMANCE CHARACTERISTICS (continued)

At $T_A = +25^\circ\text{C}$, $V_{CM} = V_S/2$, unless otherwise noted.

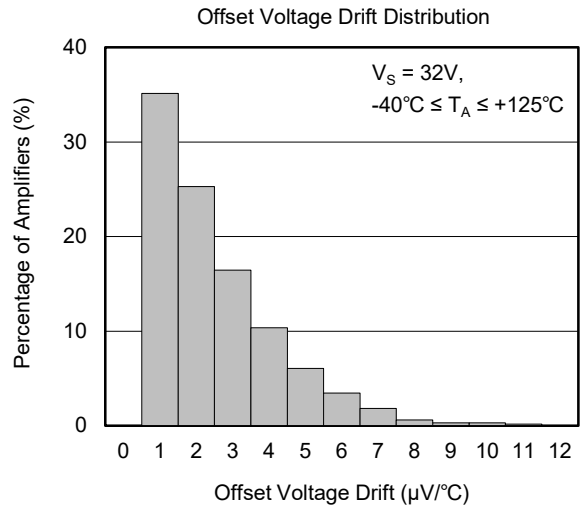
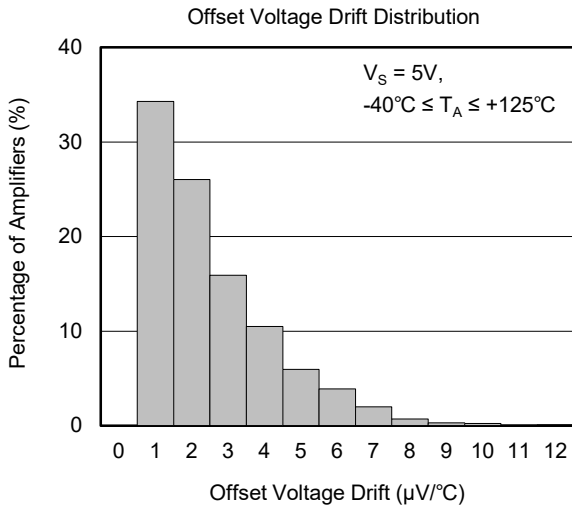
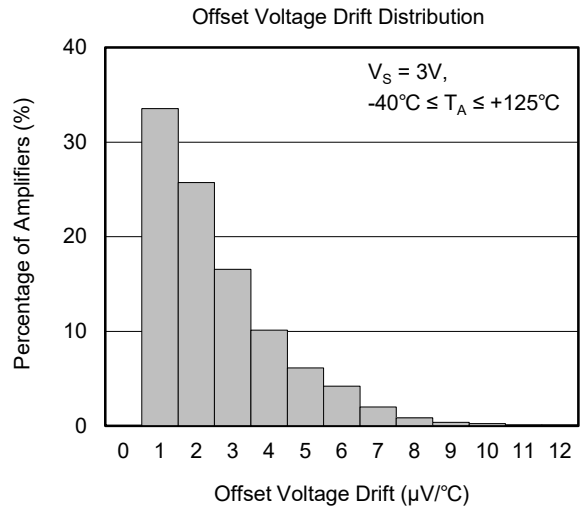
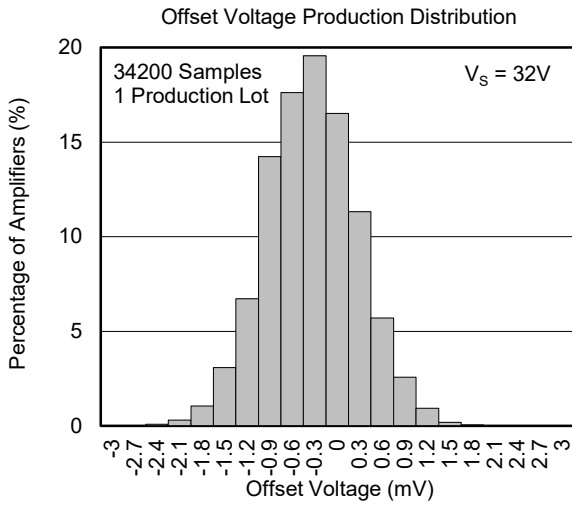

REVISION HISTORY

NOTE: Page numbers for previous revisions may differ from page numbers in the current version.

| Changes from Original (JUNE 2019) to REV.A | Page |
|--|-------------|
| Changed from product preview to production data..... | All |

PACKAGE OUTLINE DIMENSIONS

SOT-23-5

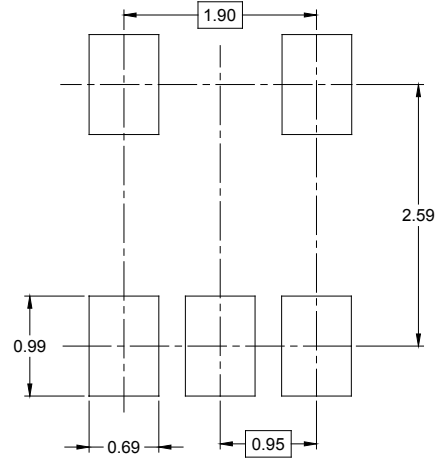
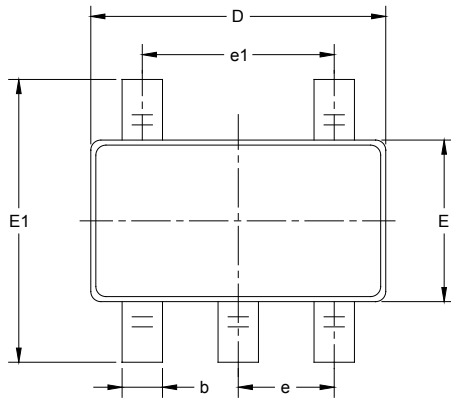

RECOMMENDED LAND PATTERN (Unit: mm)

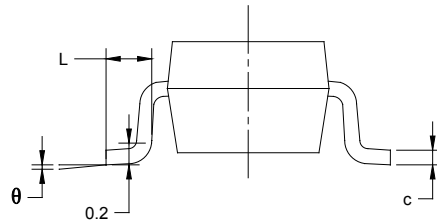
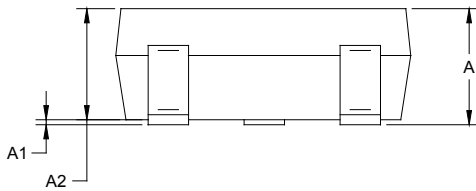

| Symbol | Dimensions In Millimeters | | Dimensions In Inches | |
|----------|------------------------------|-------|-------------------------|-------|
| | MIN | MAX | MIN | MAX |
| A | 1.050 | 1.250 | 0.041 | 0.049 |
| A1 | 0.000 | 0.100 | 0.000 | 0.004 |
| A2 | 1.050 | 1.150 | 0.041 | 0.045 |
| b | 0.300 | 0.500 | 0.012 | 0.020 |
| c | 0.100 | 0.200 | 0.004 | 0.008 |
| D | 2.820 | 3.020 | 0.111 | 0.119 |
| E | 1.500 | 1.700 | 0.059 | 0.067 |
| E1 | 2.650 | 2.950 | 0.104 | 0.116 |
| e | 0.950 BSC | | 0.037 BSC | |
| e1 | 1.900 BSC | | 0.075 BSC | |
| L | 0.300 | 0.600 | 0.012 | 0.024 |
| θ | 0° | 8° | 0° | 8° |

PACKAGE INFORMATION

TAPE AND REEL INFORMATION

REEL DIMENSIONS



TAPE DIMENSIONS



NOTE: The picture is only for reference. Please make the object as the standard.

KEY PARAMETER LIST OF TAPE AND REEL

| Package Type | Reel Diameter | Reel Width W1 (mm) | A0 (mm) | B0 (mm) | K0 (mm) | P0 (mm) | P1 (mm) | P2 (mm) | W (mm) | Pin1 Quadrant |
|--------------|---------------|--------------------|---------|---------|---------|---------|---------|---------|--------|---------------|
| SOT-23-5 | 7" | 9.5 | 3.20 | 3.20 | 1.40 | 4.0 | 4.0 | 2.0 | 8.0 | Q3 |

000001

PACKAGE INFORMATION

CARTON BOX DIMENSIONS



NOTE: The picture is only for reference. Please make the object as the standard.

KEY PARAMETER LIST OF CARTON BOX

| Reel Type | Length (mm) | Width (mm) | Height (mm) | Pizza/Carton |
|-------------|-------------|------------|-------------|--------------|
| 7" (Option) | 368 | 227 | 224 | 8 |
| 7" | 442 | 410 | 224 | 18 |

DD0002