



Is Now Part of



ON Semiconductor®

To learn more about ON Semiconductor, please visit our website at
www.onsemi.com

ON Semiconductor and the ON Semiconductor logo are trademarks of Semiconductor Components Industries, LLC dba ON Semiconductor or its subsidiaries in the United States and/or other countries. ON Semiconductor owns the rights to a number of patents, trademarks, copyrights, trade secrets, and other intellectual property. A listing of ON Semiconductor's product/patent coverage may be accessed at www.onsemi.com/site/pdf/Patent-Marking.pdf. ON Semiconductor reserves the right to make changes without further notice to any products herein. ON Semiconductor makes no warranty, representation or guarantee regarding the suitability of its products for any particular purpose, nor does ON Semiconductor assume any liability arising out of the application or use of any product or circuit, and specifically disclaims any and all liability, including without limitation special, consequential or incidental damages. Buyer is responsible for its products and applications using ON Semiconductor products, including compliance with all laws, regulations and safety requirements or standards, regardless of any support or applications information provided by ON Semiconductor. "Typical" parameters which may be provided in ON Semiconductor data sheets and/or specifications can and do vary in different applications and actual performance may vary over time. All operating parameters, including "Typicals" must be validated for each customer application by customer's technical experts. ON Semiconductor does not convey any license under its patent rights nor the rights of others. ON Semiconductor products are not designed, intended, or authorized for use as a critical component in life support systems or any FDA Class 3 medical devices or medical devices with a same or similar classification in a foreign jurisdiction or any devices intended for implantation in the human body. Should Buyer purchase or use ON Semiconductor products for any such unintended or unauthorized application, Buyer shall indemnify and hold ON Semiconductor and its officers, employees, subsidiaries, affiliates, and distributors harmless against all claims, costs, damages, and expenses, and reasonable attorney fees arising out of, directly or indirectly, any claim of personal injury or death associated with such unintended or unauthorized use, even if such claim alleges that ON Semiconductor was negligent regarding the design or manufacture of the part. ON Semiconductor is an Equal Opportunity/Affirmative Action Employer. This literature is subject to all applicable copyright laws and is not for resale in any manner.



April 2014

MB1S - MB8S 0.5 A Bridge Rectifiers

Features

- Low-Leakage
- Surge Overload Rating: 35 A peak
- Ideal for Printed Circuit Board
- UL Certified: UL #E258596

Description

The MB family of bridge rectifiers is a 0.5 A rectifier family that achieves high surge current absorption within a very small foot print. Within its small 35 mm² form factor, the MB family shines in its surge capability. In order to absorb high surge currents, the design supports a 35 A I_{FSM} rating and a 5.0 A²Sec I²T rating. Devices in the family are also rated to breakdown voltages of up to 1000 V. These features make the MB family ideal for small power supplies that need a little extra surge capability.

For higher I_{FAV} current ratings, lower profile packaging, or lower V_F values, explore the Fairchild MDB family of bridge rectifiers. For improved V_F and efficiency values in the MB package or even higher surge capability, ask about Fairchild's pending MBxSV family.

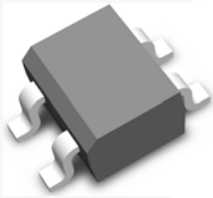

SOIC-4
Polarity symbols molded
or mark on body

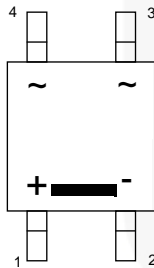

Ordering Informations

Part Number	Marking	Package	Packing Method
MB1S	MB1S	SOIC-4	Tape and Reel
MB2S	MB2S		
MB4S	MB4S		
MB6S	MB6S		
MB8S	MB8S		

Absolute Maximum Ratings

Stresses exceeding the absolute maximum ratings may damage the device. The device may not function or be operable above the recommended operating conditions and stressing the parts to these levels is not recommended. In addition, extended exposure to stresses above the recommended operating conditions may affect device reliability. The absolute maximum ratings are stress ratings only. Values are at $T_A = 25^\circ\text{C}$ unless otherwise noted.

Symbol	Parameter	Value					Unit
		MB1S	MB2S	MB4S	MB6S	MB8S	
V_{RRM}	Maximum Repetitive Reverse Voltage	100	200	400	600	800	V
V_{RMS}	Maximum RMS Bridge Input Voltage	70	140	280	420	560	V
V_R	DC Reverse Voltage (Rated V_R)	100	200	400	600	800	V
$I_{F(AV)}$	Average Rectified Forward Current at $T_A = 50^\circ\text{C}$	0.5					A
I_{FSM}	Non-Repetitive Peak Forward Surge Current: 8.3 ms Single Half-Sine-Wave	35					A
T_{STG}	Storage Temperature Range	-55 to +150					$^\circ\text{C}$
T_J	Operating Junction Temperature Range	-55 to +150					$^\circ\text{C}$

Thermal Characteristics

Symbol	Parameter	Value	Unit
P_D	Power Dissipation	1.4	W
$R_{\theta JA}$	Thermal Resistance, Junction to Ambient, per Leg ⁽¹⁾	85	$^\circ\text{C}/\text{W}$
$R_{\theta JL}$	Thermal Resistance, Junction to Lead, per Leg ⁽¹⁾	20	$^\circ\text{C}/\text{W}$

Note:

1. Device mounted on PCB with 0.5 x 0.5 inch (13 x 13 mm) lead length.

Electrical Characteristics

Values are at $T_A = 25^\circ\text{C}$ unless otherwise specified.

Symbol	Parameter	Conditions	Value	Unit
V_F	Forward Voltage, per Bridge	$I_F = 0.5 \text{ A}$	1.0	V
I_R	Reverse Current, per Leg at Rated V_R	$T_A = 25^\circ\text{C}$	5.0	μA
		$T_A = 125^\circ\text{C}$	0.5	mA
I^2t	I^2t Rating for Fusing	$t < 8.3 \text{ ms}$	5.0	A^2s
C_T	Total Capacitance, per Leg	$V_R = 4.0 \text{ V},$ $f = 1.0 \text{ MHz}$	13	pF

Typical Performance Characteristics

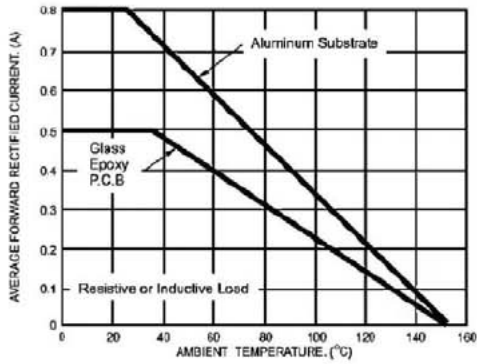

Figure 1. Derating Curve for Output Rectified Current

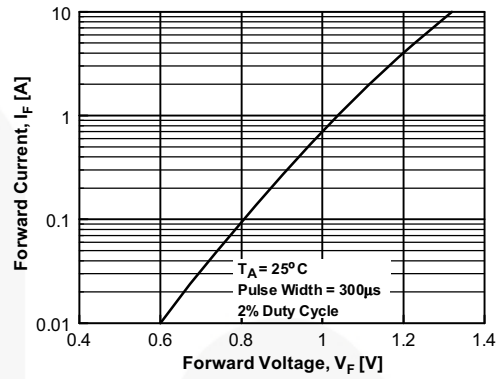

Figure 2. Forward Voltage Characteristics

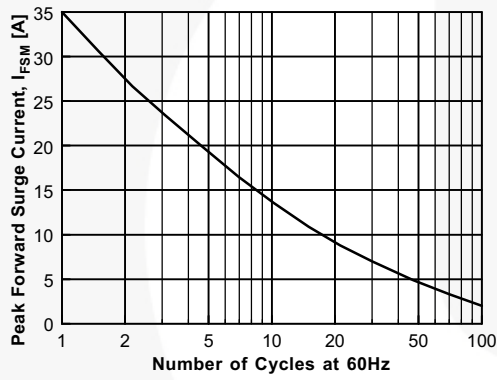

Figure 3. Non-Repetitive Surge Current

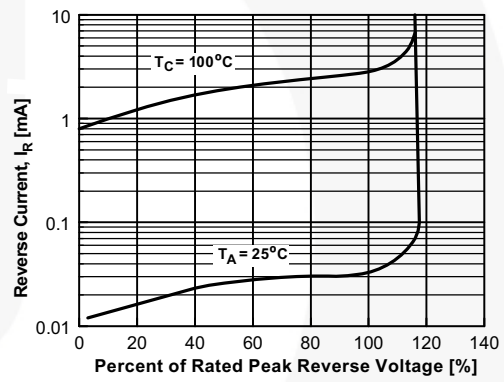
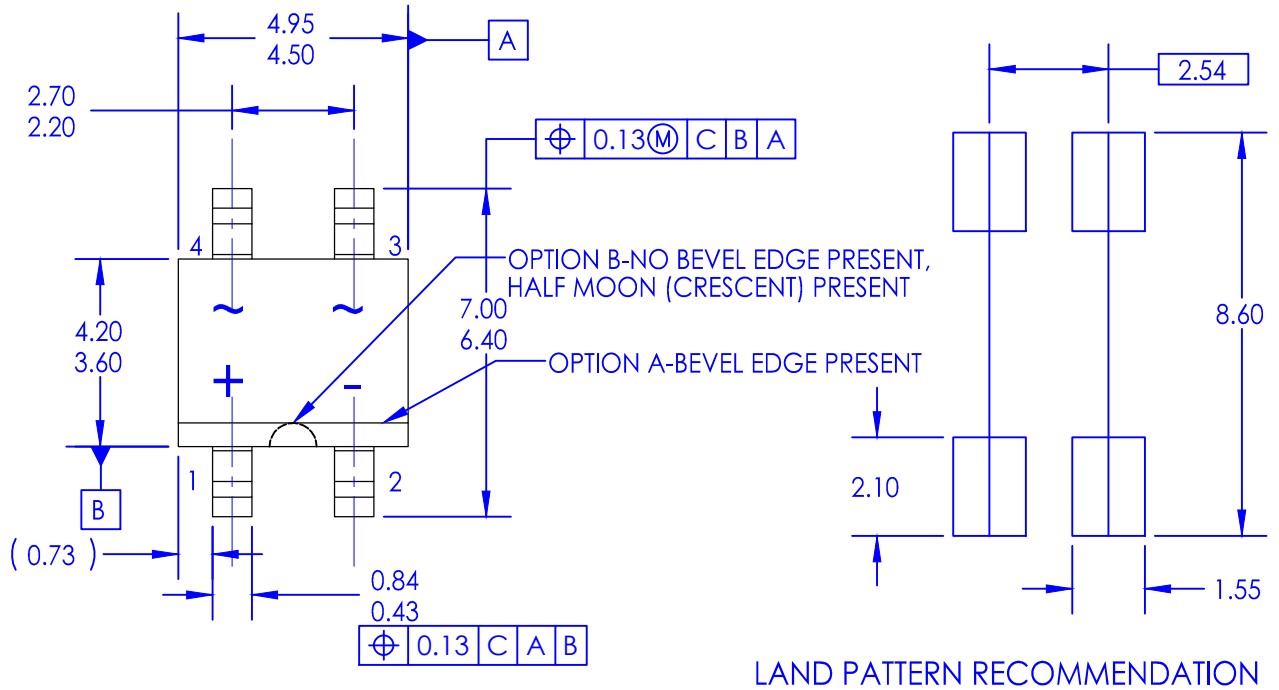
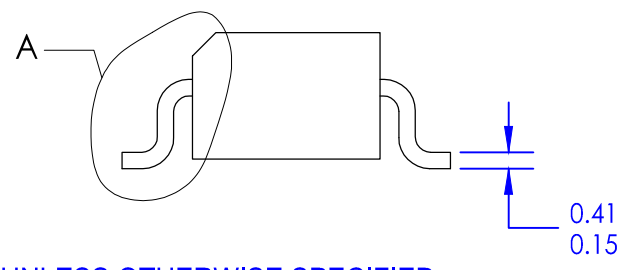
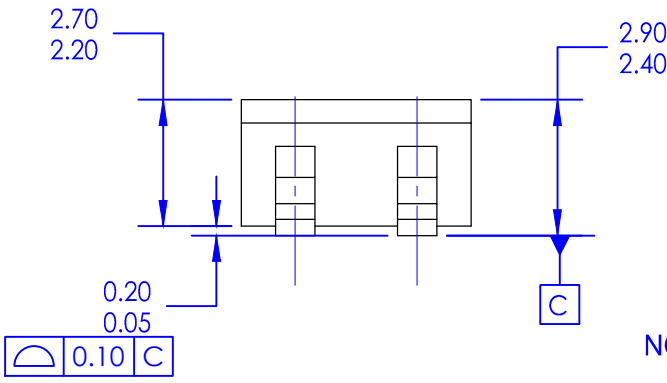

Figure 4. Reverse Current vs. Reverse Voltage



LAND PATTERN RECOMMENDATION



NOTES: UNLESS OTHERWISE SPECIFIED

- A. THIS PACKAGE DOES NOT CONFORM TO JEDEC TO269AA
- B. ALL DIMENSIONS ARE IN MILLIMETERS.
- C. DIMENSIONS ARE EXCLUSIVE OF BURRS, MOLD FLASH AND TIE BAR EXTRUSIONS.
- D. DIMENSIONS AND TOLERANCES AS PER ASME Y14.5-2009.
- E. LAND PATTERN AS PER IPC7351# SOIC254P960X400-4N
- F. FILE NAME: MKT-M04AREV3

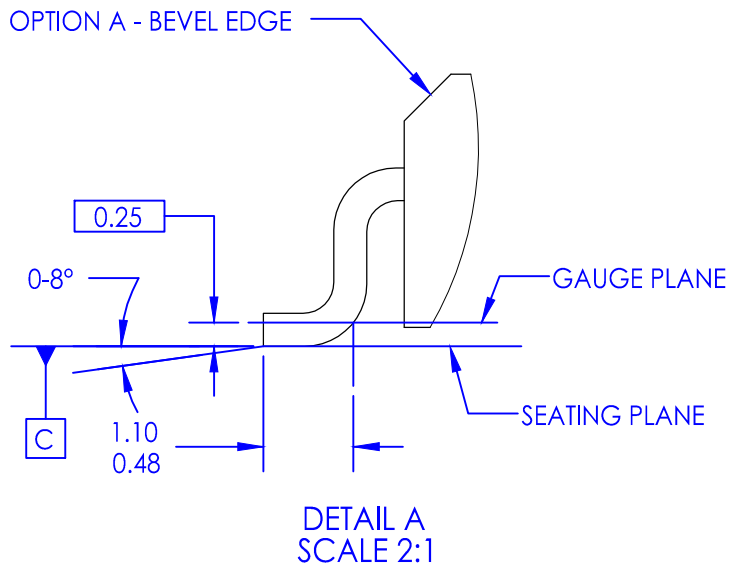

ON Semiconductor and  are trademarks of Semiconductor Components Industries, LLC dba ON Semiconductor or its subsidiaries in the United States and/or other countries. ON Semiconductor owns the rights to a number of patents, trademarks, copyrights, trade secrets, and other intellectual property. A listing of ON Semiconductor's product/patent coverage may be accessed at www.onsemi.com/site/pdf/Patent-Marking.pdf. ON Semiconductor reserves the right to make changes without further notice to any products herein. ON Semiconductor makes no warranty, representation or guarantee regarding the suitability of its products for any particular purpose, nor does ON Semiconductor assume any liability arising out of the application or use of any product or circuit, and specifically disclaims any and all liability, including without limitation special, consequential or incidental damages. Buyer is responsible for its products and applications using ON Semiconductor products, including compliance with all laws, regulations and safety requirements or standards, regardless of any support or applications information provided by ON Semiconductor. "Typical" parameters which may be provided in ON Semiconductor data sheets and/or specifications can and do vary in different applications and actual performance may vary over time. All operating parameters, including "Typicals" must be validated for each customer application by customer's technical experts. ON Semiconductor does not convey any license under its patent rights nor the rights of others. ON Semiconductor products are not designed, intended, or authorized for use as a critical component in life support systems or any FDA Class 3 medical devices or medical devices with a same or similar classification in a foreign jurisdiction or any devices intended for implantation in the human body. Should Buyer purchase or use ON Semiconductor products for any such unintended or unauthorized application, Buyer shall indemnify and hold ON Semiconductor and its officers, employees, subsidiaries, affiliates, and distributors harmless against all claims, costs, damages, and expenses, and reasonable attorney fees arising out of, directly or indirectly, any claim of personal injury or death associated with such unintended or unauthorized use, even if such claim alleges that ON Semiconductor was negligent regarding the design or manufacture of the part. ON Semiconductor is an Equal Opportunity/Affirmative Action Employer. This literature is subject to all applicable copyright laws and is not for resale in any manner.

PUBLICATION ORDERING INFORMATION

LITERATURE FULFILLMENT:

Literature Distribution Center for ON Semiconductor
19521 E. 32nd Pkwy, Aurora, Colorado 80011 USA
Phone: 303-675-2175 or 800-344-3860 Toll Free USA/Canada
Fax: 303-675-2176 or 800-344-3867 Toll Free USA/Canada
Email: orderlit@onsemi.com

N. American Technical Support: 800-282-9855 Toll Free
USA/Canada
Europe, Middle East and Africa Technical Support:
Phone: 421 33 790 2910
Japan Customer Focus Center
Phone: 81-3-5817-1050

ON Semiconductor Website: www.onsemi.com
Order Literature: <http://www.onsemi.com/orderlit>
For additional information, please contact your local
Sales Representative