



mikromedia

for PIC18FK

Compact development system rich with on-board peripherals for all-round multimedia development on PIC18F67K40 device.

TO OUR VALUED CUSTOMERS

I want to express my thanks to you for being interested in our products and for having confidence in MikroElektronika.

The primary aim of our company is to design and produce high quality electronic products and to constantly improve the performance thereof in order to better suit your needs.

A handwritten signature in white ink, appearing to read 'N. Matic', is positioned on the right side of the page. The signature is fluid and cursive, with a large initial 'N' and 'M'.

Nebojsa Matic
General Manager

Table of Contents

Introduction to mikromedia for PIC18FK	4	Programing with mikroProg programmer	15
Package Contains	5	mikroProg Suite for PIC® Software	16
Key Features	6	Programing with ICD2® or ICD3® programmer	17
System Specification	7	4. Reset Button	18
1. Power supply	8	5. microSD Card Slot	19
Battery power supply	8	6. Crystal oscillator	20
USB power supply	8	7. Audio Module	21
2. PIC18F67K40 microcontroller	9	8. Touch Screen	22
Key microcontroller features	9	9. Accelerometer	23
3. Programming the microcontroller	10	10. USB connection	24
Programming with mikroBootloader	11	11. Flash Memory	25
step 1 – Connecting mikromedia	11	12. Pinouts	26
step 2 – Browsing for .HEX file	12	13. Dimensions	27
step 3 – Selecting .HEX file	12	14. Schematic	28
step 4 – Uploading .HEX file	13	15. Mikromedia accessories	32
step 5 – Finish upload	14	What’s next?	33

Introduction to mikromedia for PIC18FK

Mikromedia for PIC18FK is a compact smart display and development platform with the PIC18F67K40 microcontroller from Microchip. The large 320x240 TFT color display will allow you to build multimedia applications with speed and ease. You can use it for development and as a final product. A 320x240 TFT Color Display with Touch Screen and Stereo MP3 Codec chip, microSD™ card, a preprogrammed PIC18FK MCU and compiler support — you are set for creating some amazing projects. It comes preprogrammed with USB bootloader, but can also be programmed with external programmers, such as mikroProg™ or ICD2/3. Mikromedia is compact and slim, and perfectly fits in the palm of the hand, which makes it convenient platform for mobile devices.



Package Contains



- 01 Damage resistant protective box



- 02 mikromedia for PIC18FK development system

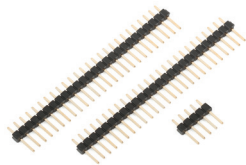

- 03 Two 1x26 male headers and one 1x5 header



- 04 USB cable

Key Features

- 01 Connection Pads
- 02 TFT 320x240 display
- 03 Micro USB connector
- 04 CHARGE indication LED
- 05 LI-Polymer battery connector
- 06 3.5mm headphone connector
- 07 Power supply regulator
- 08 Serial Flash memory
- 09 RESET button
- 10 VS1053 Stereo mp3 coder/decoder
- 11 PIC18F87J50 microcontroller
- 12 Accelerometer
- 13 Crystal oscillator
- 14 Power indication LED
- 15 microSD Card Slot
- 16 ICD2/3 connector
- 17 mikroProg connector



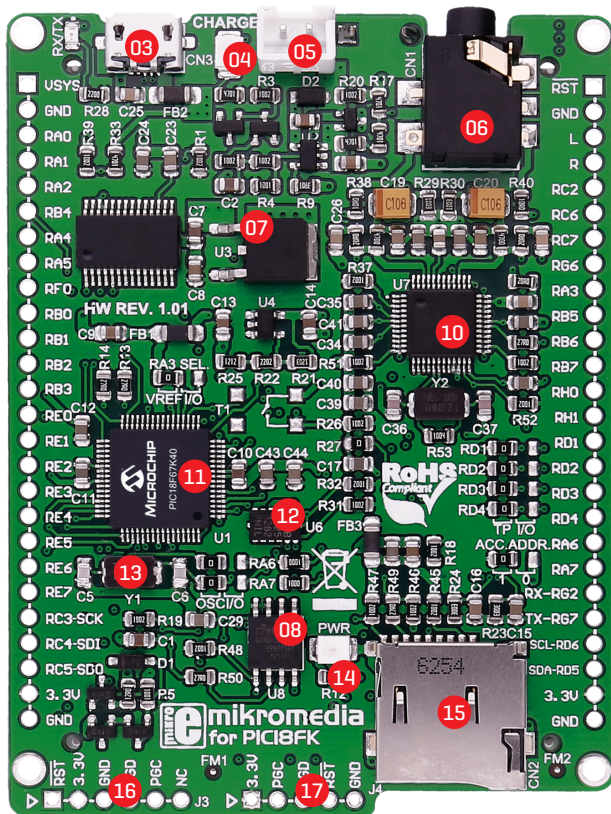

System Specification



power supply
Via USB cable [5V DC]



power consumption
52 mA with erased MCU (when back-light is ON)



board dimensions
81.2 x 60.5 mm [3.19 x 2.38 inch]



weight
~45.5g [0.10lbs]



class B product
Product complies with the Class B limit of EN 55022 and can be used in the domestic, residential, commercial and industrial environments.



CAUTION: Electrostatic Sensitive Device
Permanent damage may occur on devices subjected to high energy electrostatic discharges which readily accumulate on the human body or test equipment and can discharge without detection.

1. Power supply

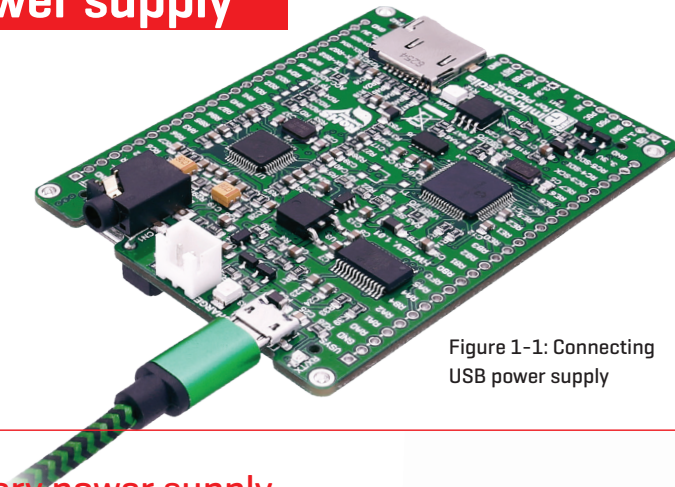

Figure 1-1: Connecting USB power supply

USB power supply

USB power supply - You can apply power supply to the board using micro USB cable provided with the board. On-board voltage regulators provide the appropriate voltage levels to each component on the board. Power LED [green] will indicate the presence of power supply.

Battery power supply

You can also power the board using **Li-Polymer** battery, via on-board battery connector. On-board battery charger circuit **MCP73832** enables you to charge the battery over USB connection. **LED diode [RED]** will indicate when battery is charging. Charging current is ~250mA and charging voltage is 4.2V DC.

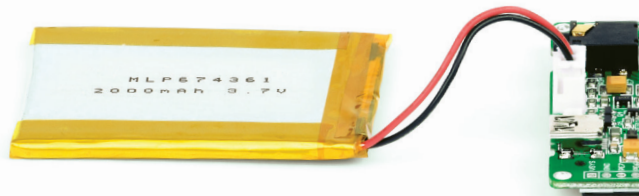

Figure 1-2: Connecting Li-Polymer battery

2. PIC18F67K40 microcontroller

PIC18F67K40 is a 64-Pin, low-power, high performance microcontroller with XLP technology. equipped with a 10-bit ADC with Computation (ADCC) automating Capacitive Voltage Divider (CVD) techniques for advanced touch sensing, averaging, filtering, oversampling and performing automatic threshold comparisons.

Key MCU features

- 128K bytes Program Flash
 - 3568 Bytes Data SRAM
 - 1024 Bytes Data EEPROM
- Sleep mode: Lowest Power Consumption



3. Programming the microcontroller

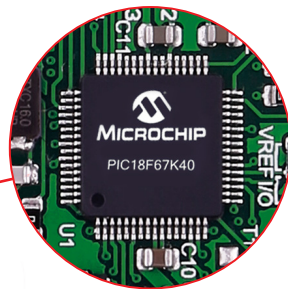
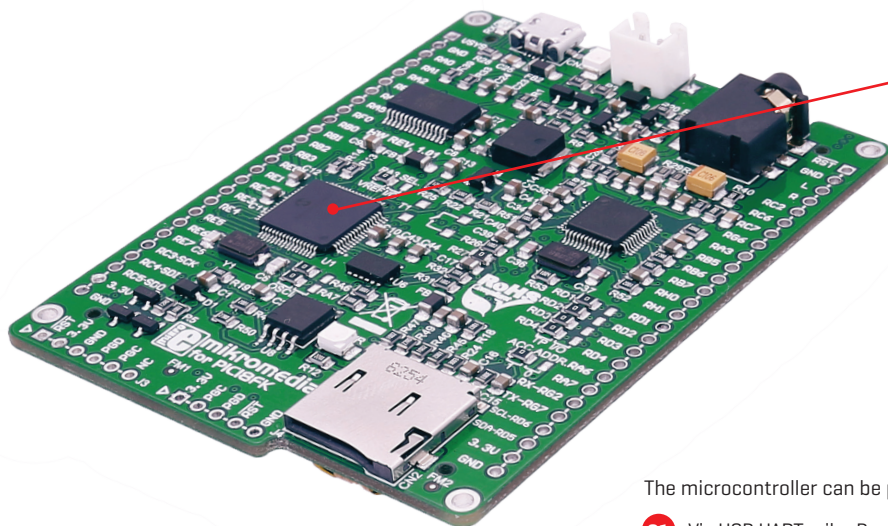

Figure 3-1:
PIC18F67K40
microcontroller

The microcontroller can be programmed in three ways:

- 01 Via USB UART mikroBootloader
- 02 Using mikroProg external programmer
- 03 Using ICD2/3® external programmer

3.1 Programming with mikroBootloader

You can program the microcontroller with a bootloader which is preprogrammed by default. To transfer .hex file from a PC to MCU you need bootloader software [mikroBootloader USB HID] which can be downloaded from:

<https://download.mikroe.com/examples/starter-boards/clicker-2/pic18fk/clicker-2-pic18fk-mikrobootloader-v100.zip>

After the mikroBootloader software is downloaded, unzip it to desired location and start it.

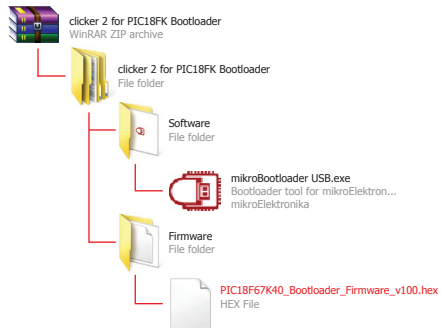

step 1 – Connecting clicker 2 for PIC18FK

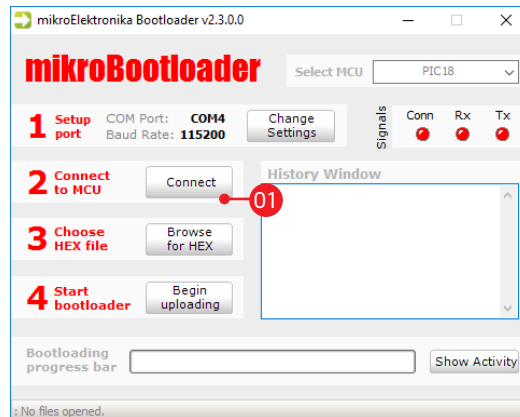

Figure 3-2: mikroBootloader window

01 To start, connect the USB cable, or if already connected press the Reset button on your clicker 2 for PIC18FK. Click the Connect button within 5s to enter the bootloader mode, otherwise existing microcontroller program will execute.

step 2 – Browsing for .HEX file

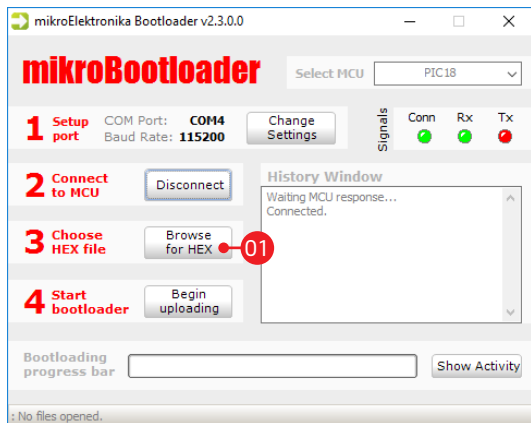

Figure 3-3: Browse for HEX

- 01 Click the Browse for HEX button and from a pop-up window [Figure 3-4] choose the .HEX file which will be uploaded to MCU memory.

step 3 – Selecting .HEX file

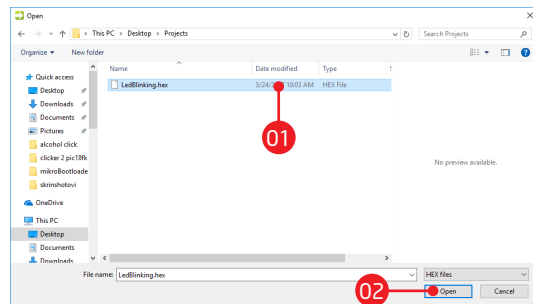

Figure 3-4: Selecting HEX

- 01 Select .HEX file using open dialog window.
- 02 Click the Open button.

step 4 – Uploading .HEX file

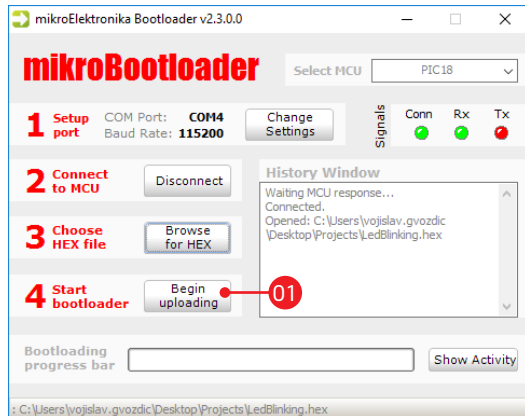

Figure 3-5: Begin uploading

- 01** To start .HEX file bootloading click the Begin uploading button.

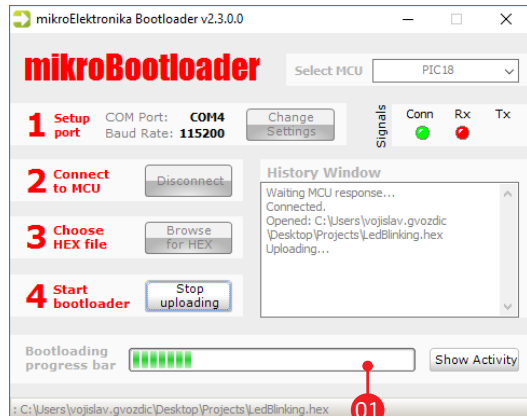

Figure 3-6: Progress bar

- 01** Progress bar enables you to monitor .HEX file uploading.

step 5 – Finish upload

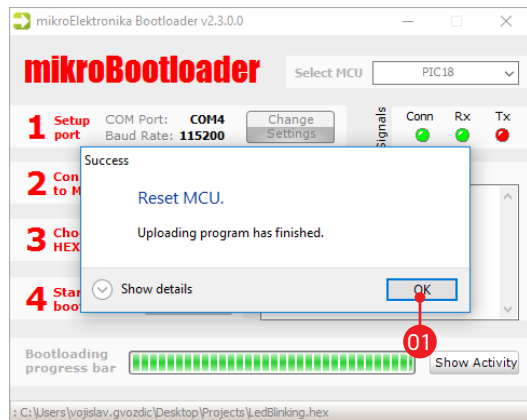

Figure 3-7: Restarting MCU

- 01 Click OK button after the uploading process is finished.
- 02 Press Reset button on clicker 2 for PIC18FK board and wait for 5 seconds. Your program will run automatically.

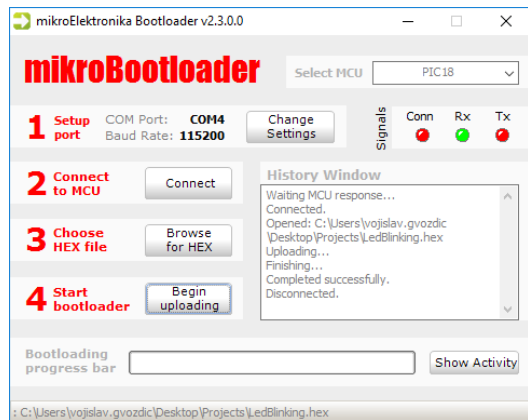

Figure 3-8: mikroBootloader ready for next job

Programming with mikroProg programmer

The microcontroller can be programmed with **mikroProg programmer** and **mikroProg Suite for PIC®** software. The mikroProg programmer is connected to the development system via the CN6 connector, **Figure 3-9**.

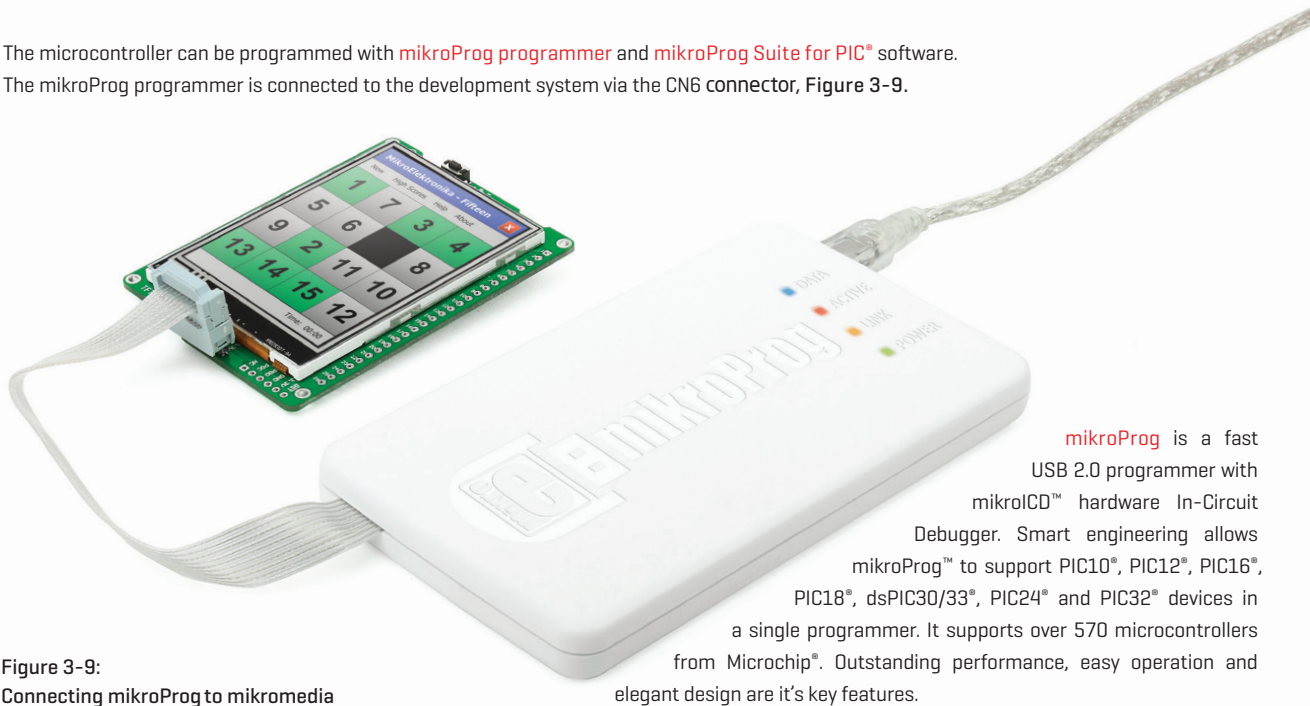

Figure 3-9:
Connecting mikroProg to mikromedia

mikroProg is a fast USB 2.0 programmer with mikroCD™ hardware In-Circuit Debugger. Smart engineering allows mikroProg™ to support PIC10®, PIC12®, PIC16®, PIC18®, dsPIC30/33®, PIC24® and PIC32® devices in a single programmer. It supports over 570 microcontrollers from Microchip®. Outstanding performance, easy operation and elegant design are its key features.

mikroProg Suite for PIC software

mikroProg programmer requires special programming software called mikroProg Suite for PIC. This software is used for programming of ALL Microchip® microcontroller families, including PIC10®, PIC12®, PIC16®, PIC18®, dsPIC30/33®, PIC24® and PIC32®. Software has intuitive interface and SingleClick™ programming technology. Just by downloading the latest version of mikroProg Suite your programmer is ready to program new devices. mikroProg Suite is updated regularly, at least four times a year, so your programmer will be more and more powerful with each new release.

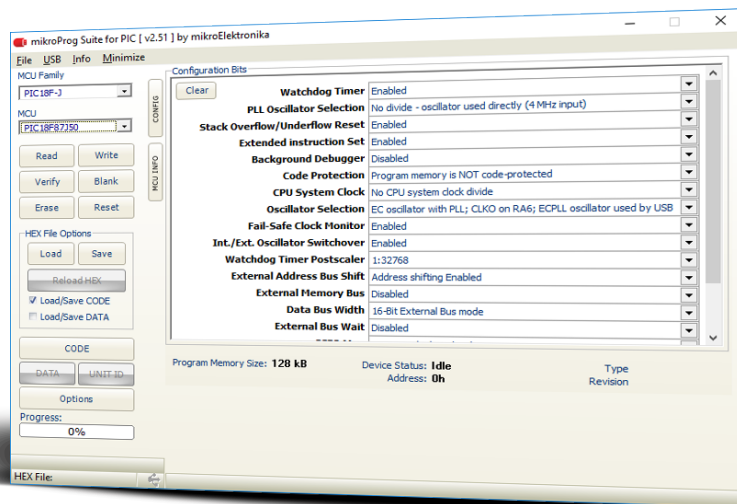

Figure 3-10: Main window of mikroProg Suite for PIC® programming software

Programming with ICD2® or ICD3® programmer

The microcontroller can be also programmed with **ICD2® or ICD3® programmer**. These programmers connects with mikromedia board via **ICD2 CONNECTOR BOARD**.

In order to enable the ICD2® and ICD3® programmers to be connected to the development system, it is necessary to provide the appropriate connector such as the ICD2 CONNECTOR BOARD. This connector should be first soldered on the CN5 connector. Then you should plug the ICD2® or ICD3® programmer into it, Figure 3-11.

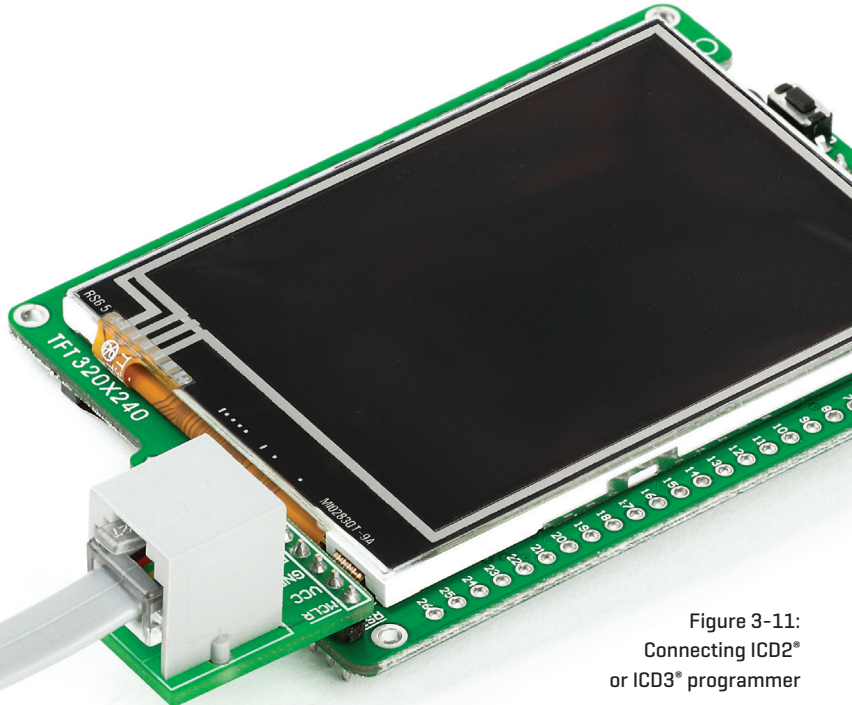
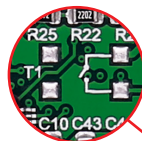

Figure 3-11:
Connecting ICD2®
or ICD3® programmer

4. Reset Button

Board is equipped with reset button, which is located at the top of the front side [Figure 4-2]. If you want to reset the circuit, press the reset button. It will generate low voltage level on microcontroller reset pin [input]. In addition, a reset can be externally provided through pin 27 on side headers [Figure 4-3].



NOTE

You can also solder additional reset button on the appropriate place at the back side of the board, Figure 4-1.

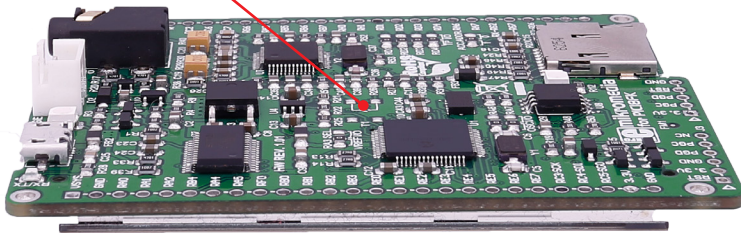

Figure 4-1: Location of additional reset button

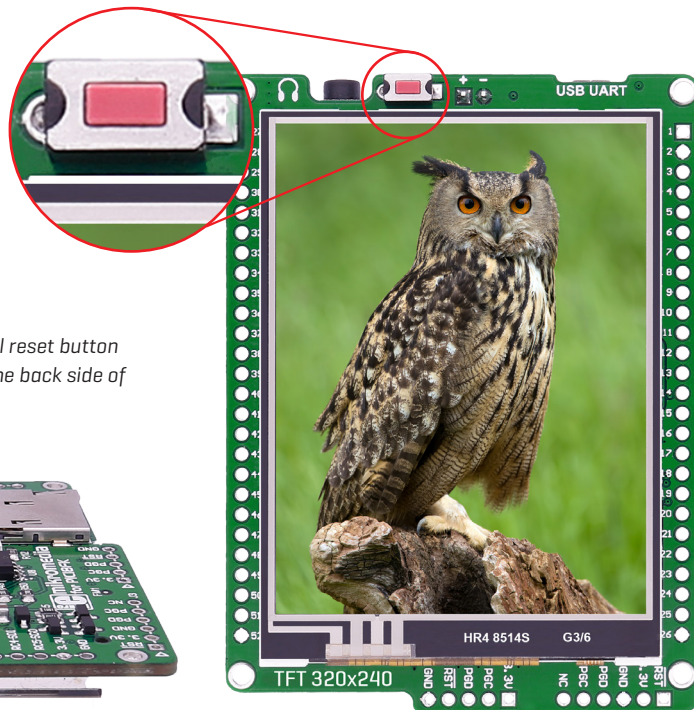

Figure 4-2: Frontal reset button

5. microSD Card Slot

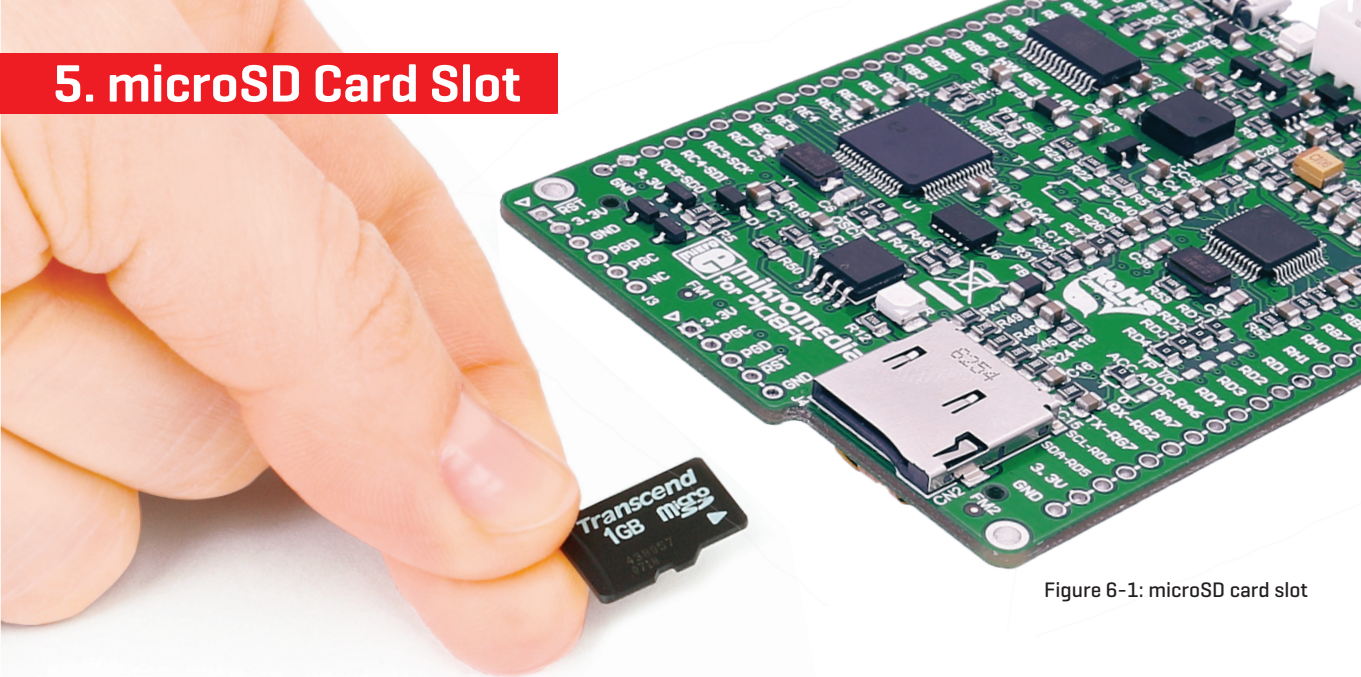

Figure 6-1: microSD card slot

Board contains **microSD card slot** for using microSD cards in your projects. It enables you to store large amounts of data externally, thus saving microcontroller memory. microSD cards use Serial Peripheral Interface (SPI) for communication with the microcontroller.

6. Crystal oscillator

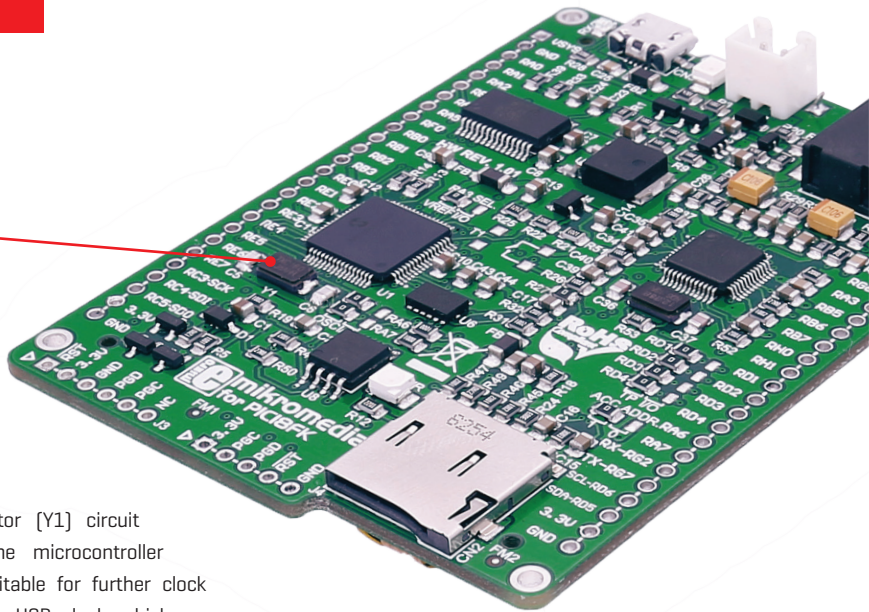

Figure 5-1:
Crystal oscillator module

Board is equipped with 16MHz crystal oscillator [Y1] circuit that provides external clock waveform to the microcontroller CLK0 and CLKI pins. This base frequency is suitable for further clock multipliers and ideal for generation of necessary USB clock, which ensures proper operation of bootloader and your custom USB-based applications.

NOTE: The use of crystal in all other schematics is implied even if it is purposely left out, because of the schematics clarity.

7. Audio Module

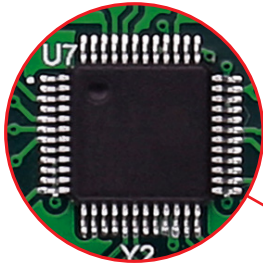
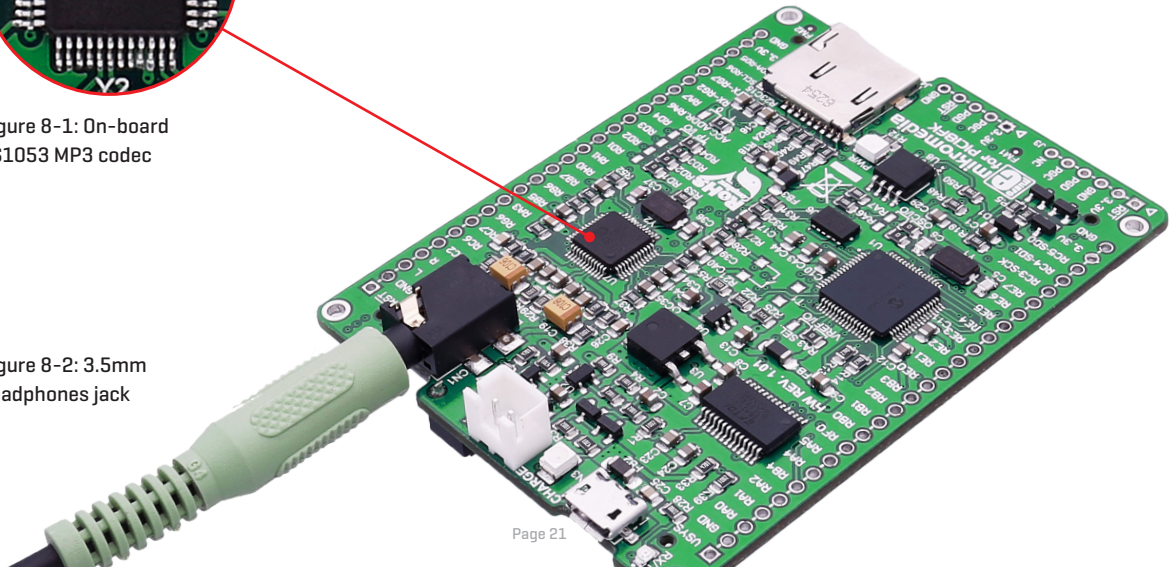

Figure 8-1: On-board VS1053 MP3 codec

The mikromedia for PIC18FK features stereo audio codec VS1053. This module enables audio reproduction by using stereo headphones connected to the system via a 3.5mm connector CN2. All functions of this module are controlled by the microcontroller over Serial Peripheral Interface [SPI].

Figure 8-2: 3.5mm headphones jack



8. Touch Screen

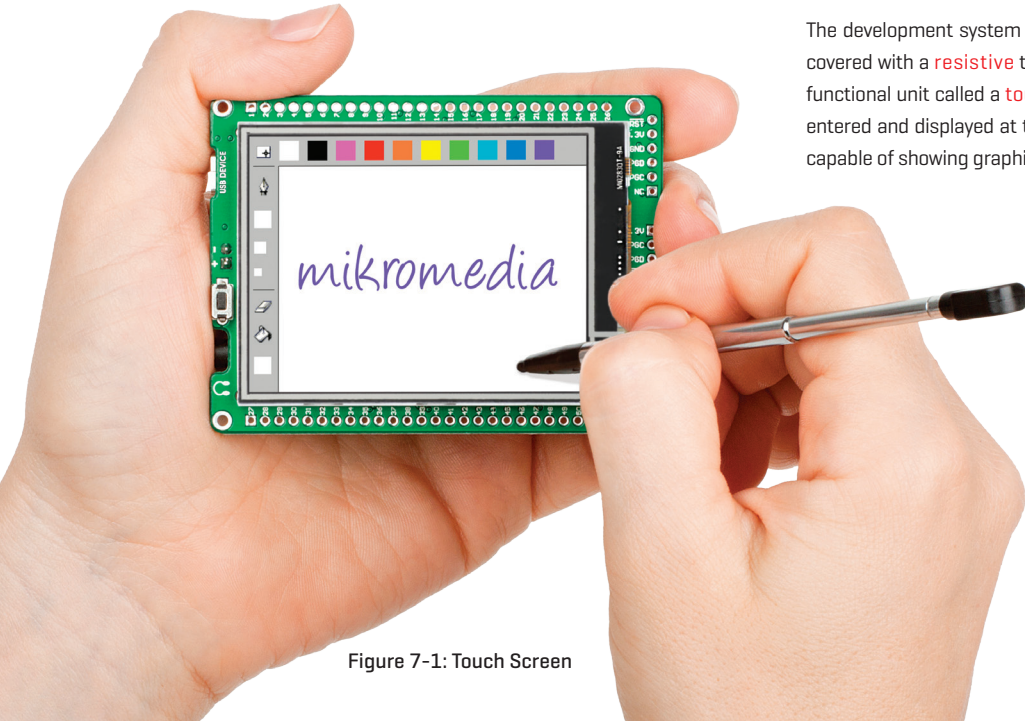

The development system features a **TFT 320x240 display** covered with a **resistive** touch panel. Together they form a functional unit called a **touch screen**. It enables data to be entered and displayed at the same time. The TFT display is capable of showing graphics in **262.144** different **colors**.

Figure 7-1: Touch Screen

9. Accelerometer

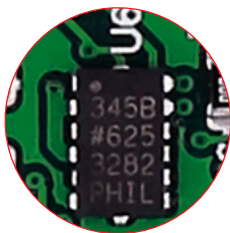
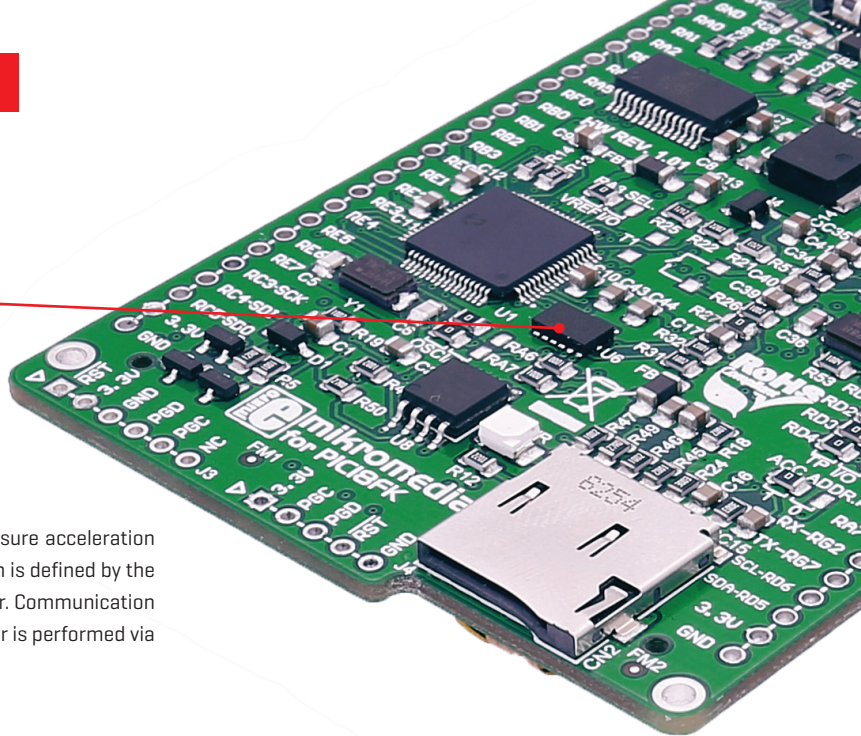

Figure 10-1:
Accelerometer
module



On board **ADXL345** accelerometer is used to measure acceleration in three axis: x, y and z. The accelerometer function is defined by the user in the program loaded into the microcontroller. Communication between the accelerometer and the microcontroller is performed via the **I²C** interface.



You can set the accelerometer address to 0 or 1 by re-soldering the SMD jumper [zero-ohm resistor] to the appropriate position. Jumper is placed in address 1 position by default.

10. USB connection

Figure 9-1: Connecting USB cable to Micro USB connector

PIC18F67K40 microcontroller has an integrated USB module, which enables you to implement USB communication functionality to your mikromedia board. Connection with target USB host is done over micro USB connector which is positioned next to the battery connector.

11. Flash Memory

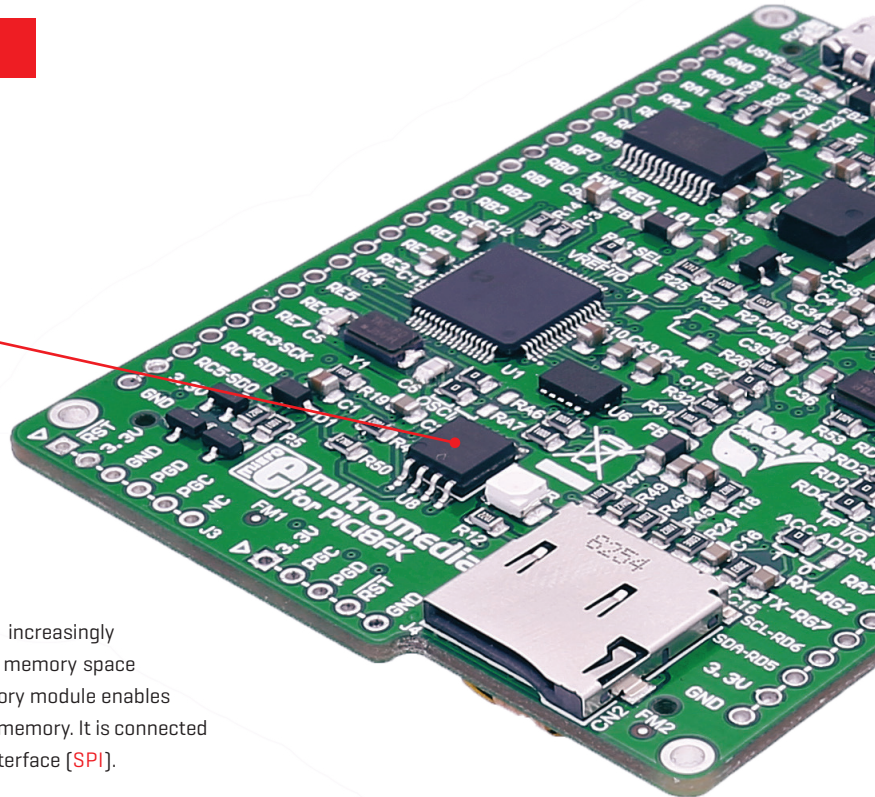
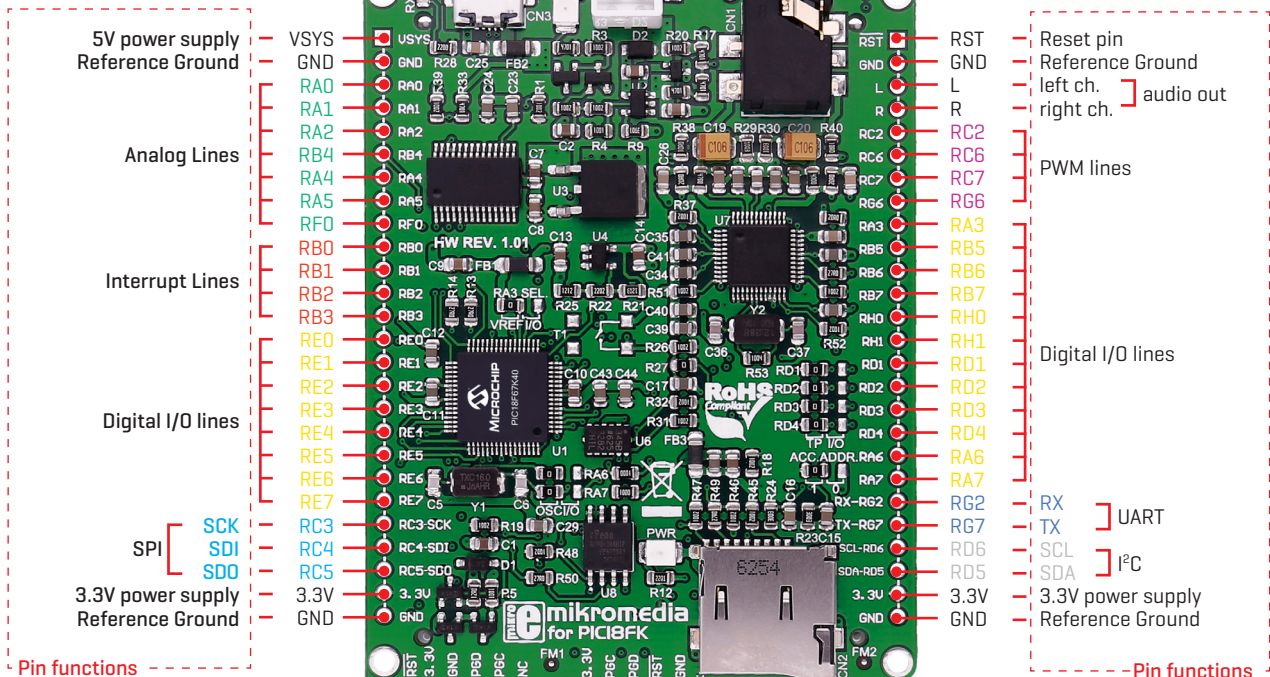

Figure 11-1: Flash memory module

Since multimedia applications are getting increasingly demanding, it is necessary to provide additional memory space to be used for storing more data. The flash memory module enables the microcontroller to use additional **8Mbit** flash memory. It is connected to the microcontroller via the Serial Peripheral Interface [SPI].

12. Pinout



■ Digital lines
 ■ Analog Lines
 ■ Interrupt Lines
 ■ SPI Lines
 ■ I2C Lines
 ■ UART lines
 ■ PWM lines

13. Dimensions

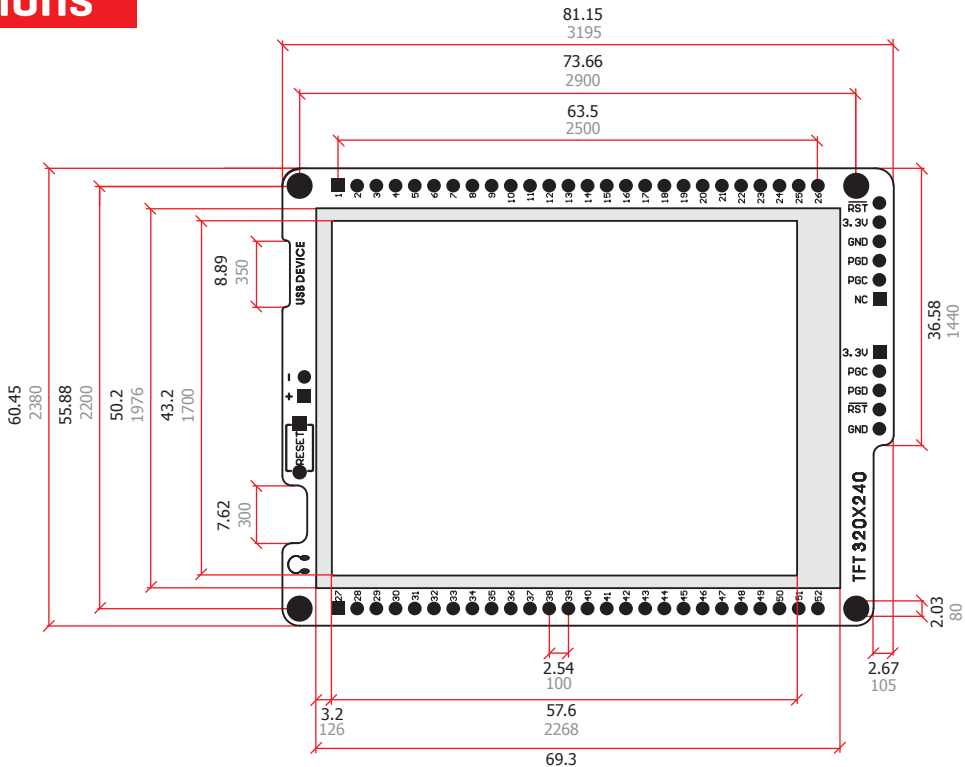
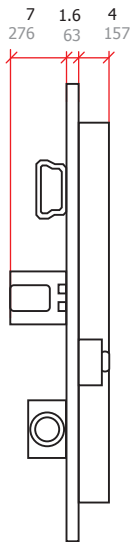

Legend

- mm
- mils

14. Schematic

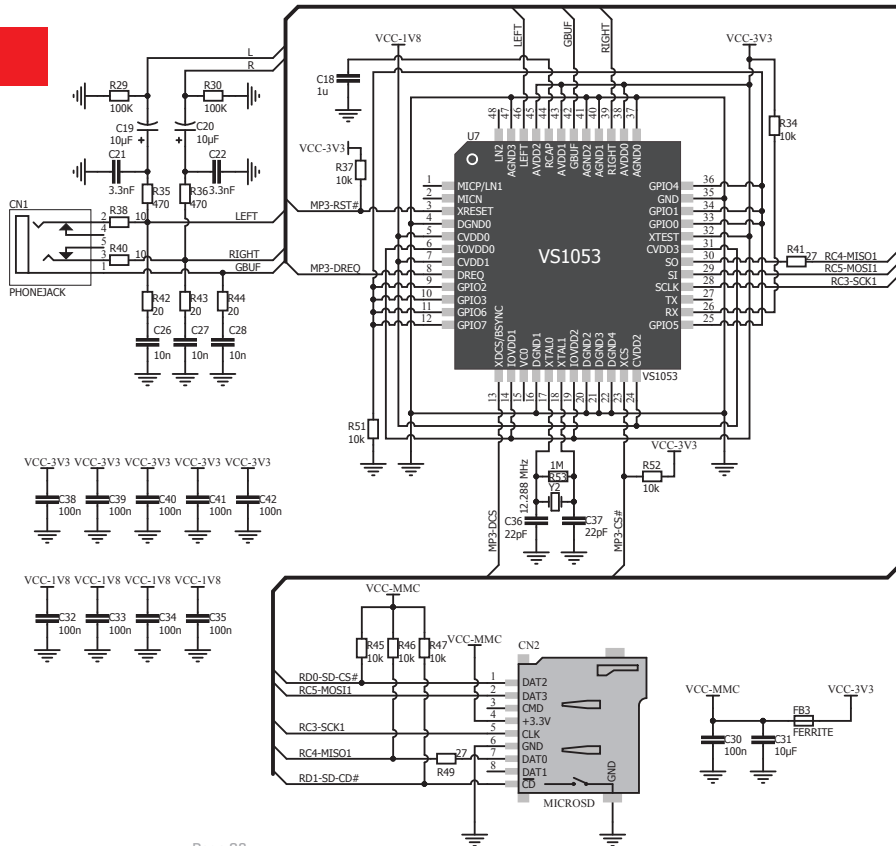

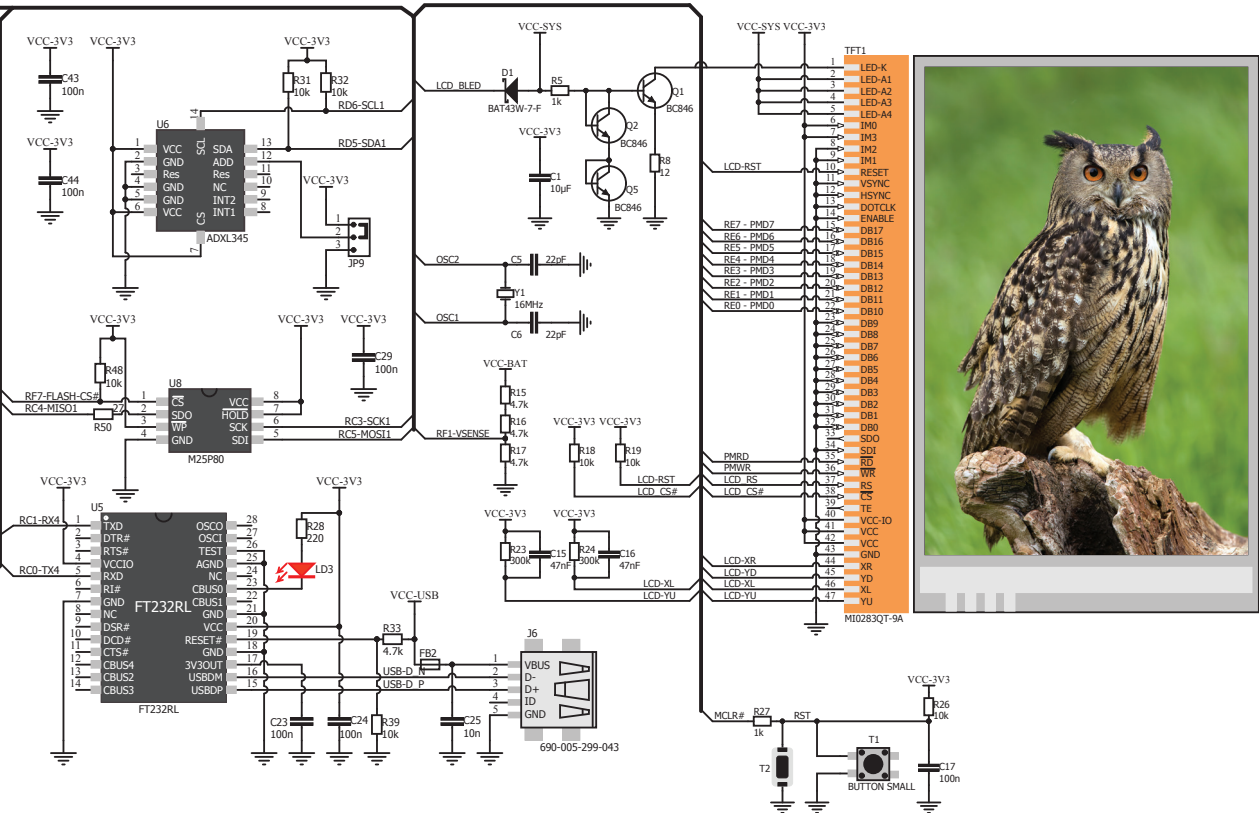

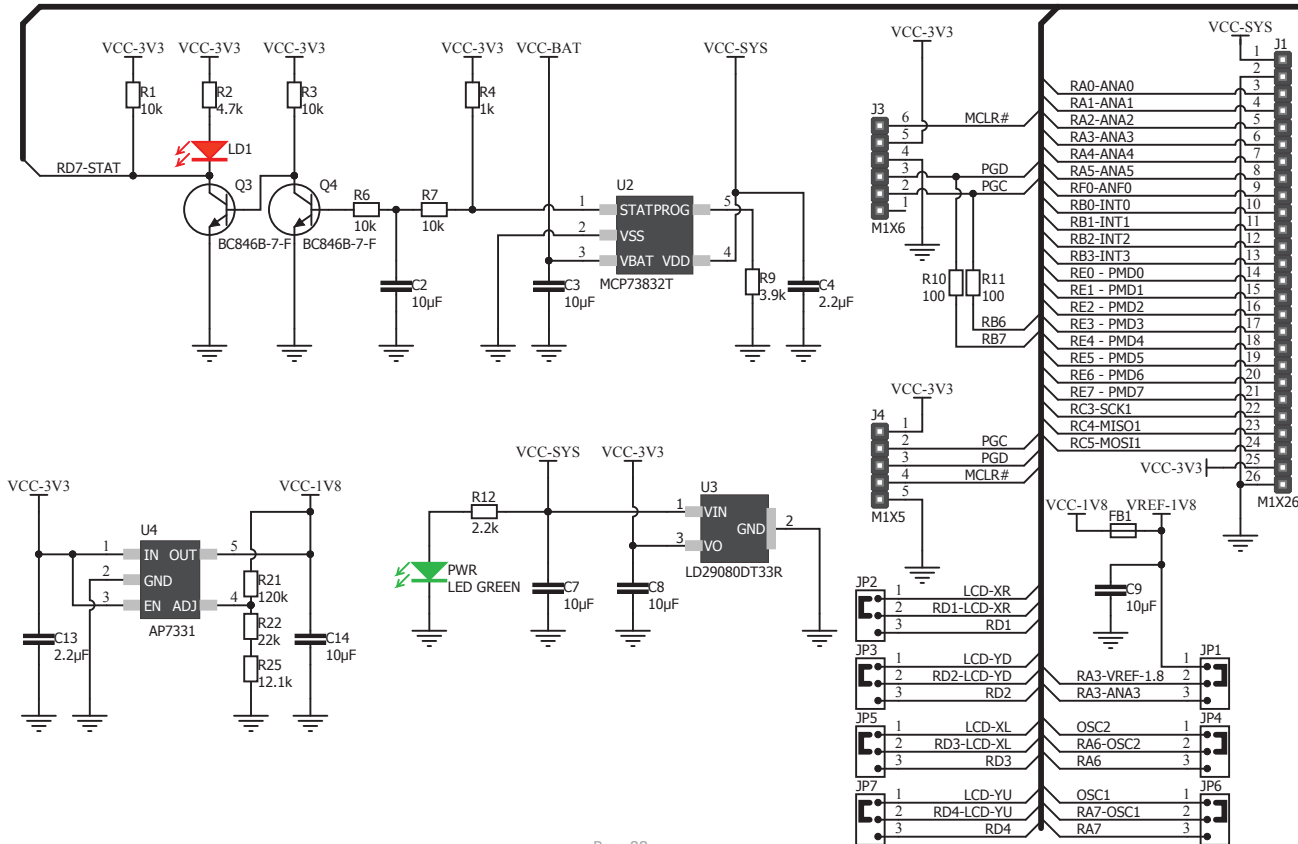

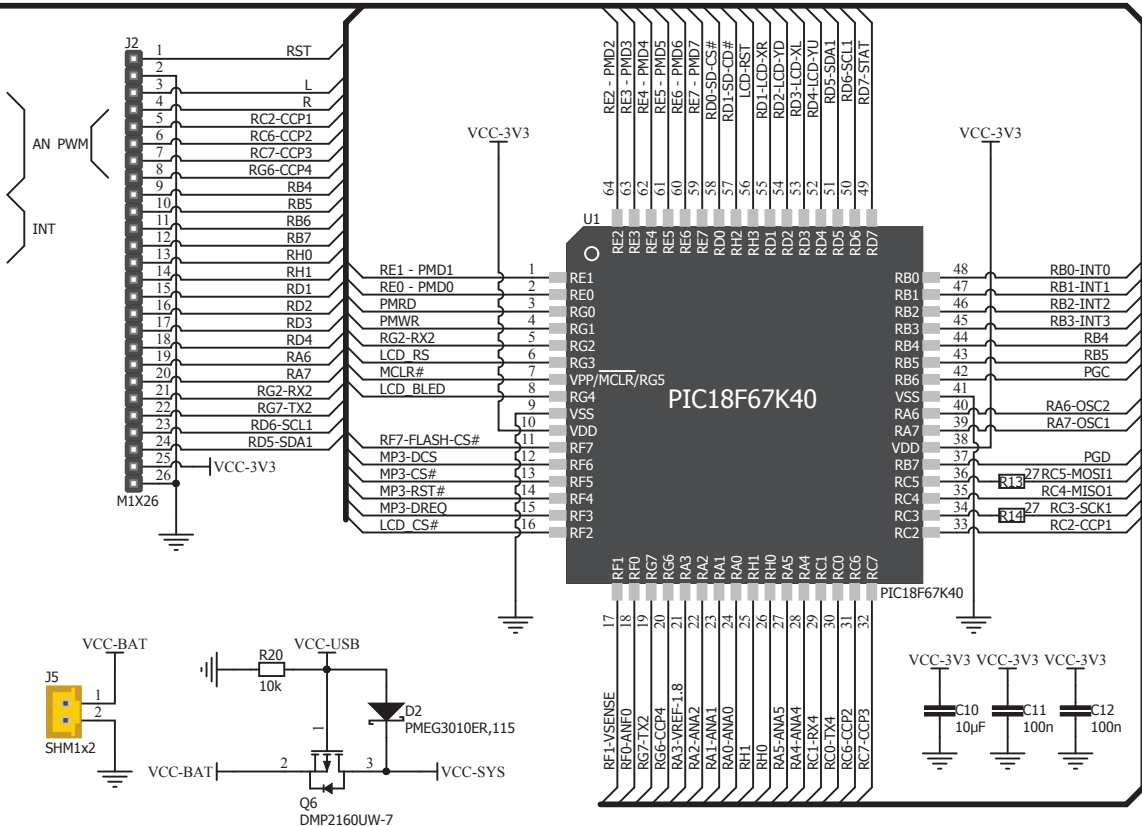

15. Mikromedia accessories

We have prepared a set of extension boards pin-compatible with your mikromedia, which enable you to easily expand your board basic functionality. We call them mikromedia shields. But we also offer other accessories, such as Li-polymer battery, stacking headers, wire jumpers and more.

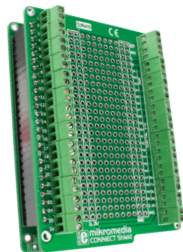

01 Connect shield

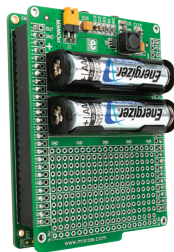

02 BatteryBoost shield

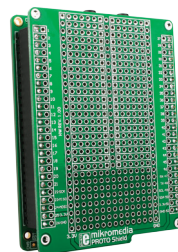

03 PROTO shield

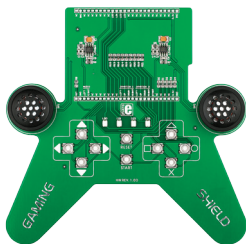

04 Gaming shield

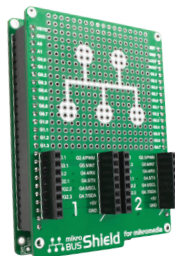

05 mikroBUS shield



06 Li-Polymer battery

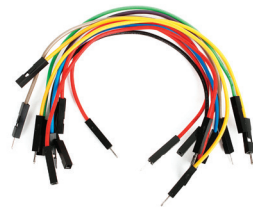

07 Wire Jumpers

What's next?

You have now completed the journey through each and every feature of mikromedia for PIC18FK board. You got to know it's modules and organization. Now you are ready to start using your new board. We are suggesting several steps which are probably the best way to begin. We invite you to join the users of mikromedia™ brand. You will find very useful projects and tutorials and can get help from a large ecosystem of users. Welcome!

Compiler

You still don't have an appropriate compiler? Locate PIC® compiler that suits you best on our site:

<https://shop.mikroe.com/compilers>

Choose between mikroC, mikroBasic and mikroPascal and download fully functional demo version, so you can begin building your first applications.



Projects

Once you have chosen your compiler, and since you already got the board, you are ready to start writing your first projects. **Visual TFT software** for rapid development of graphical user interfaces enables you to quickly create your GUI. It will automatically create necessary code which is compatible with mikroElektronika compilers. Visual TFT is rich with examples, which are an excellent starting point for your future projects. Just load the example, read well commented code, and see how it works on hardware. Visual TFT is also available on our site:

<https://shop.mikroe.com/software-tools>

Notes:

DISCLAIMER

All the products owned by MikroElektronika are protected by copyright law and international copyright treaty. Therefore, this manual is to be treated as any other copyright material. No part of this manual, including product and software described herein, may be reproduced, stored in a retrieval system, translated or transmitted in any form or by any means, without the prior written permission of MikroElektronika. The manual PDF edition can be printed for private or local use, but not for distribution. Any modification of this manual is prohibited.

MikroElektronika provides this manual 'as is' without warranty of any kind, either expressed or implied, including, but not limited to, the implied warranties or conditions of merchantability or fitness for a particular purpose.

MikroElektronika shall assume no responsibility or liability for any errors, omissions and inaccuracies that may appear in this manual. In no event shall MikroElektronika, its directors, officers, employees or distributors be liable for any indirect, specific, incidental or consequential damages (including damages for loss of business profits and business information, business interruption or any other pecuniary loss) arising out of the use of this manual or product, even if MikroElektronika has been advised of the possibility of such damages. MikroElektronika reserves the right to change information contained in this manual at any time without prior notice, if necessary.

HIGH RISK ACTIVITIES

The products of MikroElektronika are not fault – tolerant nor designed, manufactured or intended for use or resale as on – line control equipment in hazardous environments requiring fail – safe performance, such as in the operation of nuclear facilities, aircraft navigation or communication systems, air traffic control, direct life support machines or weapons systems in which the failure of Software could lead directly to death, personal injury or severe physical or environmental damage ['High Risk Activities']. MikroElektronika and its suppliers specifically disclaim any expressed or implied warranty of fitness for High Risk Activities.

TRADEMARKS

The MikroElektronika name and logo, mikroC, mikroBasic, mikroPascal, Visual TFT, Visual GLCD, mikroProg, Ready, MINI, mikroBUS™, EasyPIC, EasyAVR, Easy8051, click boards™ and mikromedia are trademarks of MikroElektronika. All other trademarks mentioned herein are property of their respective companies.

All other product and corporate names appearing in this manual may or may not be registered trademarks or copyrights of their respective companies, and are only used for identification or explanation and to the owners' benefit, with no intent to infringe.



If you want to learn more about our products, please visit our web site at www.mikroe.com

If you are experiencing some problems with any of our products or just need additional information, please place your ticket at www.mikroe.com/support

If you have any questions, comments or business proposals,
do not hesitate to contact us at office@mikroe.com