

SWITCHMODE™ Series PNP Silicon Power Transistors

The MJE5850, MJE5851 and the MJE5852 transistors are designed for high-voltage, high-speed, power switching in inductive circuits where fall time is critical. They are particularly suited for line operated SWITCHMODE applications such as:

- Switching Regulators
- Inverters
- Solenoid and Relay Drivers
- Motor Controls
- Deflection Circuits

Fast Turn-Off Times

100 ns Inductive Fall Time @ 25°C (Typ)
125 ns Inductive Crossover Time @ 25°C (Typ)

Operating Temperature Range -65 to +150°C

100°C Performance Specified for:

- Reversed Biased SOA with Inductive Loads
- Switching Times with Inductive Loads
- Saturation Voltages
- Leakage Currents

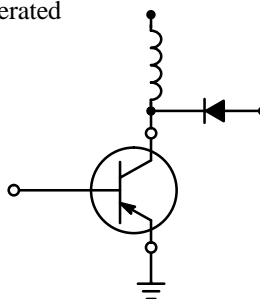

MJE5850
MJE5851*
MJE5852*

*ON Semiconductor Preferred Device

8 AMPERE
PNP SILICON
POWER TRANSISTORS
300, 350, 400 VOLTS
80 WATTS

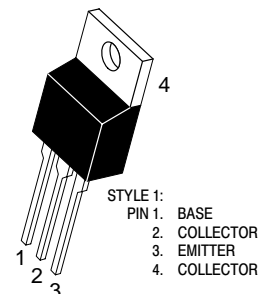

CASE 221A-09
TO-220AB

MAXIMUM RATINGS

Rating	Symbol	MJE5850	MJE5851	MJE5852	Unit
Collector-Emitter Voltage	$V_{CEO(sus)}$	300	350	400	Vdc
Collector-Emitter Voltage	V_{CEV}	350	400	450	Vdc
Emitter Base Voltage	V_{EB}	6.0			Vdc
Collector Current — Continuous Peak (1)	I_C I_{CM}	8.0 1.6			Adc
Base Current — Continuous Peak (1)	I_B I_{BM}	4.0 8.0			Adc
Total Power Dissipation @ $T_C = 25^\circ\text{C}$ Derate above 25°C	P_D	80 0.640			Watts W/°C
Operating and Storage Junction Temperature Range	T_J, T_{stg}	-65 to 150			°C

THERMAL CHARACTERISTICS

Characteristic	Symbol	Max	Unit
Thermal Resistance, Junction to Case	$R_{\theta JC}$	1.25	°C/W
Maximum Lead Temperature for Soldering Purposes: 1/8" from Case for 5 Seconds	T_L	275	°C

(1) Pulse Test: Pulse Width = 5 ms, Duty Cycle ≤ 10%.

Preferred devices are ON Semiconductor recommended choices for future use and best overall value.

MJE5850 MJE5851 MJE5852

ELECTRICAL CHARACTERISTICS (T_C = 25°C unless otherwise noted)

Characteristic	Symbol	Min	Typ	Max	Unit
----------------	--------	-----	-----	-----	------

OFF CHARACTERISTICS

Collector–Emitter Sustaining Voltage (I _C = 10 mA, I _B = 0)	MJE5850 MJE5851 MJE5852	V _{CEO(sus)}	300 350 400	— — —	— — —	V _{dc}
Collector Cutoff Current (V _{CEV} = Rated Value, V _{BE(off)} = 1.5 V _{dc}) (V _{CEV} = Rated Value, V _{BE(off)} = 1.5 V _{dc} , T _C = 100°C)		I _{CEV}	— —	— —	0.5 2.5	mAdc
Collector Cutoff Current (V _{CE} = Rated V _{CEV} , R _{BE} = 50 Ω, T _C = 100°C)		I _{CER}	—	—	3.0	mAdc
Emitter Cutoff Current (V _{EB} = 6.0 V _{dc} , I _C = 0)		I _{EBO}	—	—	1.0	mAdc

SECOND BREAKDOWN

Second Breakdown Collector Current with base forward biased	I _{S/b}	See Figure 12
Clamped Inductive SOA with base reverse biased	RBSOA	See Figure 13

*ON CHARACTERISTICS

DC Current Gain (I _C = 2.0 Adc, V _{CE} = 5 V _{dc}) (I _C = 5.0 Adc, V _{CE} = 5 V _{dc})	h _{FE}	15 5	— —	— —	— —
Collector–Emitter Saturation Voltage (I _C = 4.0 Adc, I _B = 1.0 Adc) (I _C = 8.0 Adc, I _B = 3.0 Adc) (I _C = 4.0 Adc, I _B = 1.0 Adc, T _C = 100°C)	V _{CE(sat)}	— — —	— — —	2.0 5.0 2.5	V _{dc}
Base–Emitter Saturation Voltage (I _C = 4.0 Adc, I _B = 1.0 Adc) (I _C = 4.0 Adc, I _B = 1.0 Adc, T _C = 100°C)	V _{BE(sat)}	— —	— —	1.5 1.5	V _{dc}

DYNAMIC CHARACTERISTICS

Output Capacitance (V _{CB} = 10 V _{dc} , I _E = 0, f _{test} = 1.0 kHz)	C _{ob}	—	270	—	pF
--	-----------------	---	-----	---	----

SWITCHING CHARACTERISTICS

Resistive Load (Table 1)						
Delay Time	(V _{CC} = 250 V _{dc} , I _C = 4.0 A, I _{B1} = 1.0 A, t _p = 50 μs, Duty Cycle ≤ 2%)	t _d	—	0.025	0.1	μs
Rise Time		t _r	—	0.100	0.5	μs
Storage Time	(V _{CC} = 250 V _{dc} , I _C = 4.0 A, I _{B1} = 1.0 A, V _{BE(off)} = 5 V _{dc} , t _p = 50 μs, Duty Cycle ≤ 2%)	t _s	—	0.60	2.0	μs
Fall Time		t _f	—	0.11	0.5	μs
Inductive Load, Clamped (Table 1)						
Storage Time	(I _{CM} = 4 A, V _{CEM} = 250 V, I _{B1} = 1.0 A, V _{BE(off)} = 5 V _{dc} , T _C = 100°C)	t _{sv}	—	0.8	3.0	μs
Crossover Time		t _c	—	0.4	1.5	μs
Fall Time		t _{fi}	—	0.1	—	μs
Storage Time	(I _{CM} = 4 A, V _{CEM} = 250 V, I _{B1} = 1.0 A, V _{BE(off)} = 5 V _{dc} , T _C = 25°C)	t _{sv}	—	0.5	—	μs
Crossover Time		t _c	—	0.125	—	μs
Fall Time		t _{fi}	—	0.1	—	μs

*Pulse Test: PW = 300 μs. Duty Cycle ≤ 2%

TYPICAL ELECTRICAL CHARACTERISTICS

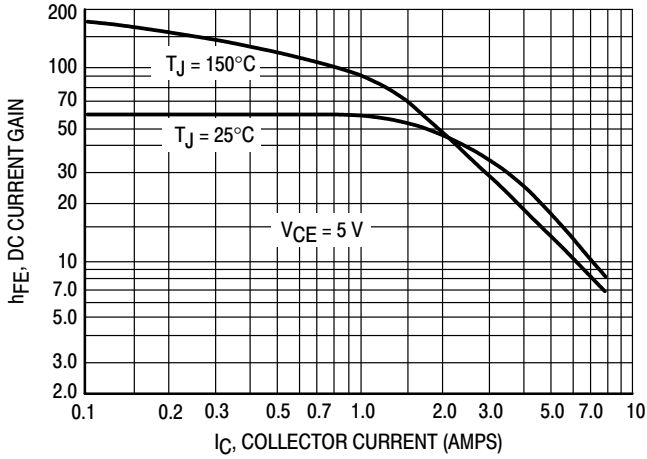

Figure 1. DC Current Gain

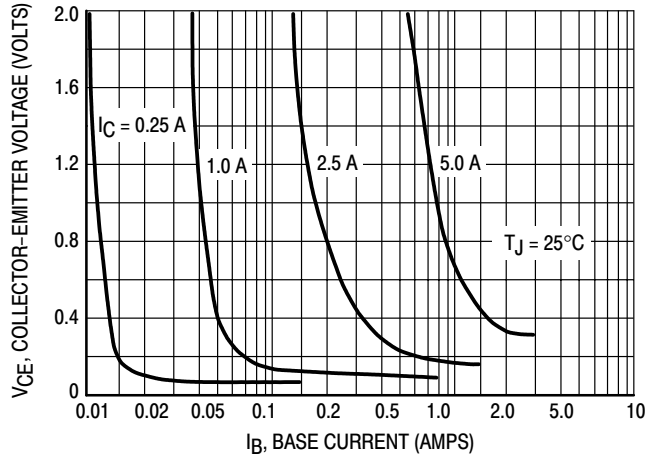

Figure 2. Collector Saturation Region

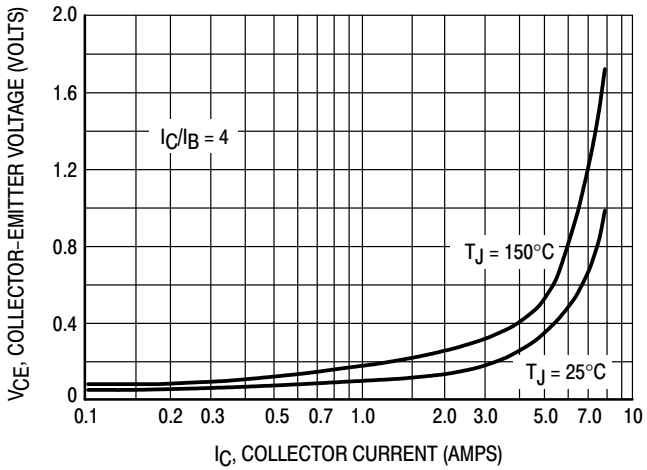

Figure 3. Collector-Emitter Saturation Voltage

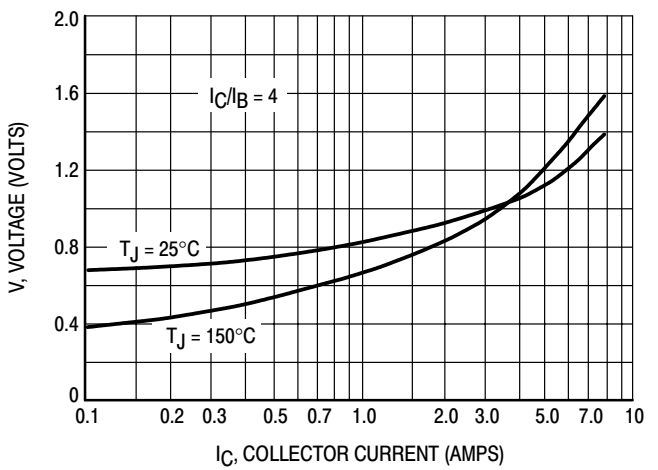

Figure 4. Base-Emitter Voltage

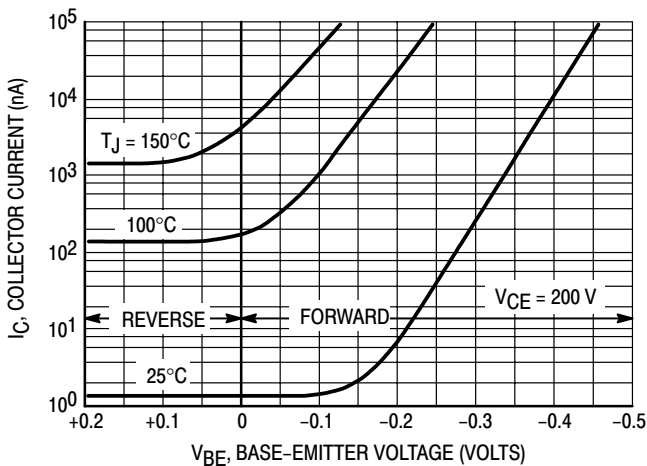

Figure 5. Collector Cutoff Region

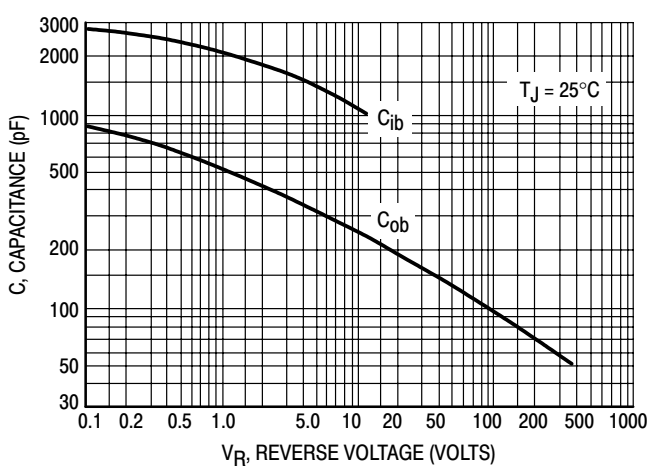

Figure 6. Capacitance

MJE5850 MJE5851 MJE5852

Table 1. Test Conditions for Dynamic Performance

	V _{CEO(sus)}	RBSOA AND INDUCTIVE SWITCHING	RESISTIVE SWITCHING
INPUT CONDITIONS	<p>PW Varied to Attain I_C = 100 mA</p>	<p>-V adjusted to obtain desired I_{B1} +V adjusted to obtain desired V_{BE(off)}</p>	<p>TURN-ON TIME</p> <p>I_{B1} adjusted to obtain the forced h_{FE} desired</p> <p>TURN-OFF TIME</p> <p>Use inductive switching driver as the input to the resistive test circuit.</p>
CIRCUIT VALUES	L _{coil} = 80 mH, V _{CC} = 10 V R _{coil} = 0.7 Ω	L _{coil} = 180 μH R _{coil} = 0.05 Ω V _{CC} = 20 V V _{clamp} = 250 V R _B adjusted to attain desired I _{B1}	V _{CC} = 250 V R _L = 62 Ω Pulse Width = 10 μs
TEST CIRCUITS	<p>INDUCTIVE TEST CIRCUIT</p> <p>SEE ABOVE FOR DETAILED CONDITIONS</p>	<p>OUTPUT WAVEFORMS</p> <p>t₁ Adjusted to Obtain I_C</p> $t_1 \approx \frac{L_{coil} (I_{CM})}{V_{CC}}$ $t_2 \approx \frac{L_{coil} (I_{CM})}{V_{Clamp}}$ <p>Test Equipment Scope — Tektronix 475 or Equivalent</p>	<p>RESISTIVE TEST CIRCUIT</p>

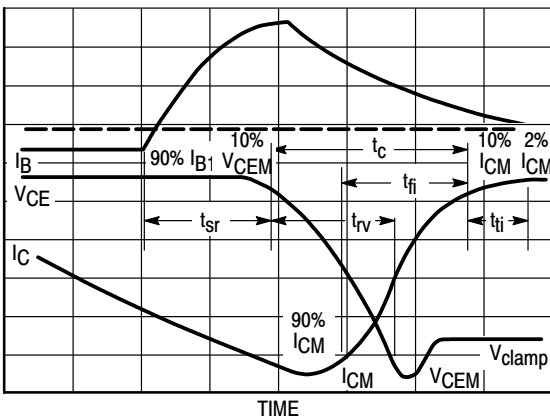

Figure 7. Inductive Switching Measurements

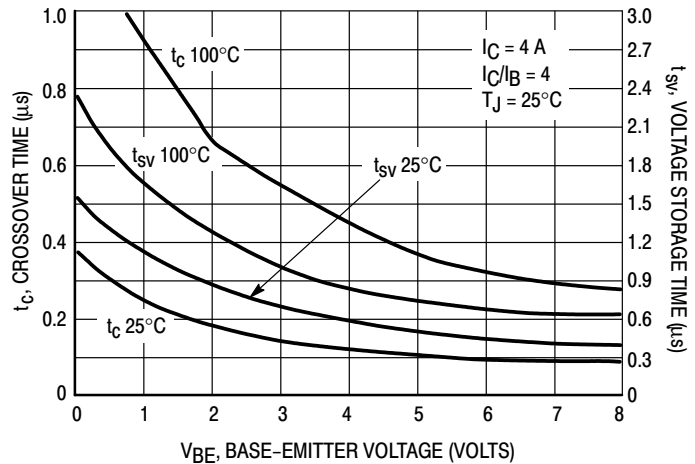

Figure 8. Inductive Switching Times

SWITCHING TIMES NOTE

In resistive switching circuits, rise, fall, and storage times have been defined and apply to both current and voltage waveforms since they are in phase. However, for inductive loads which are common to SWITCHMODE power supplies and hammer drivers, current and voltage waveforms are not in phase. Therefore, separate measurements must be made on each waveform to determine the total switching time. For this reason, the following new terms have been defined.

- t_{SV} = Voltage Storage Time, 90% I_{B1} to 10% V_{CEM}
- t_{RV} = Voltage Rise Time, 10–90% V_{CEM}
- t_{fi} = Current Fall Time, 90–10% I_{CM}
- t_{ti} = Current Tail, 10–2% I_{CM}
- t_c = Crossover Time, 10% V_{CEM} to 10% I_{CM}

An enlarged portion of the inductive switching waveform is shown in Figure 7 to aid on the visual identity of these terms.

For the designer, there is minimal switching loss during storage time and the predominant switching power losses occur during the crossover interval and can be obtained using the standard equation from AN-222A:

$$P_{SWT} = 1/2 V_{CC} I_C (t_c) f$$

In general, $t_{RV} + t_{fi} \approx t_c$. However, at lower test currents this relationship may not be valid.

As is common with most switching transistors, resistive switching is specified at 25°C and has become a benchmark for designers. However, for designers of high frequency converter circuits, the user oriented specifications which make this a “SWITCHMODE” transistor are the inductive switching speeds (t_c and t_{SV}) which are guaranteed at 100°C.

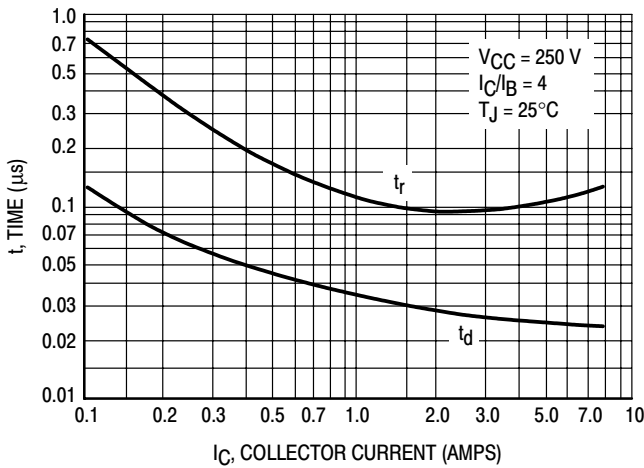

Figure 9. Turn-On Switching Times

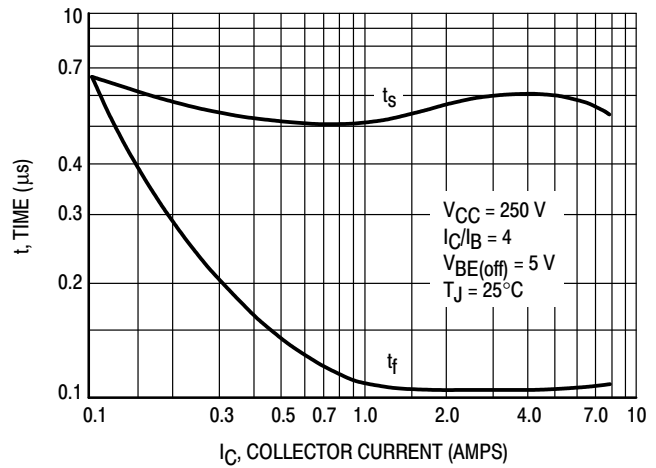

Figure 10. Turn-Off Switching Time

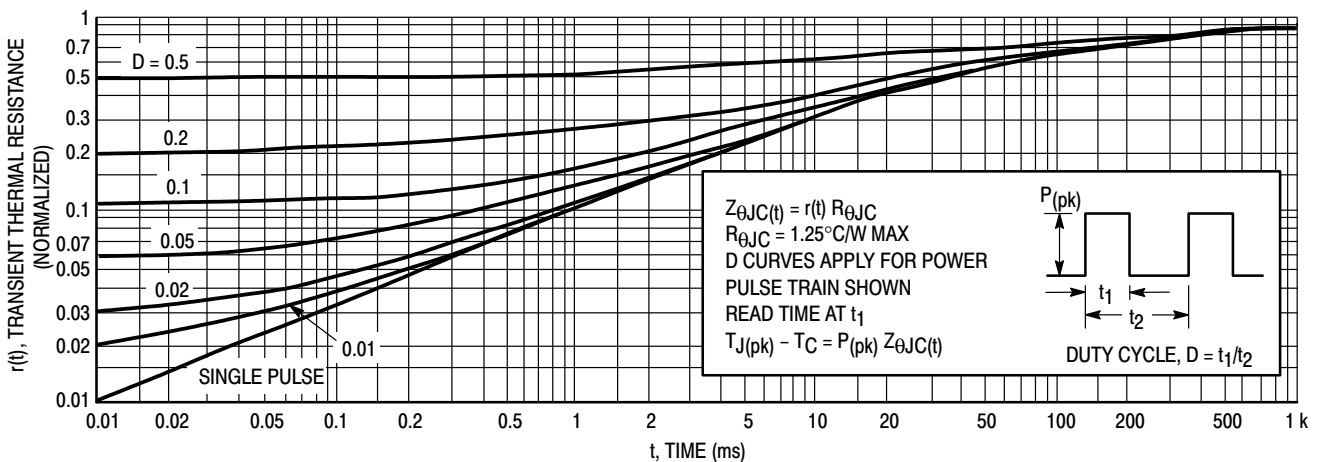

Figure 11. Typical Thermal Response [$Z_{\theta JC}(t)$]

The Safe Operating Area figures shown in Figures 12 and 13 are specified for these devices under the test conditions shown.

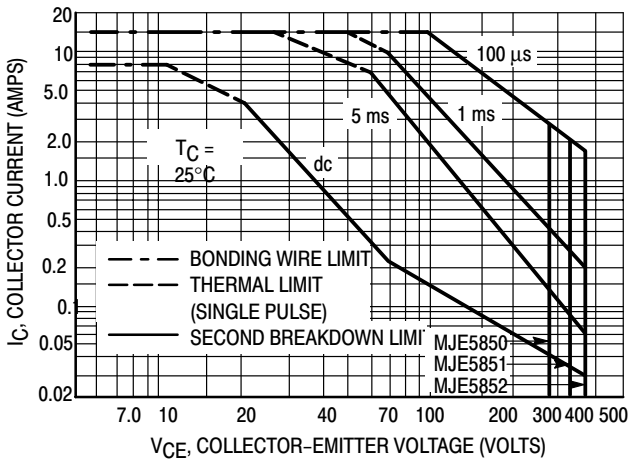

Figure 12. Maximum Forward Bias Safe Operating Area

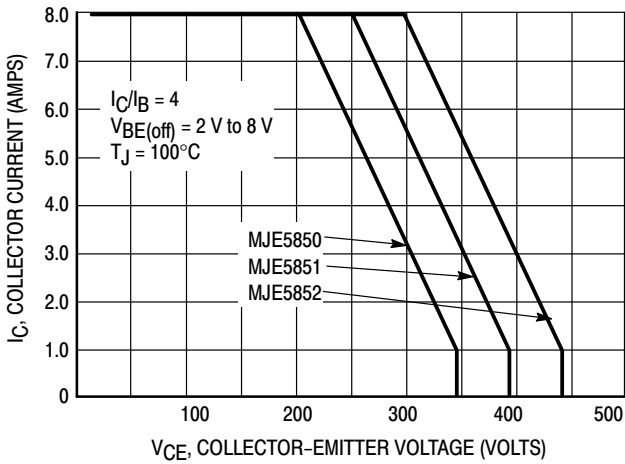

Figure 13. RBSOA, Maximum Reverse Bias Safe Operating Area

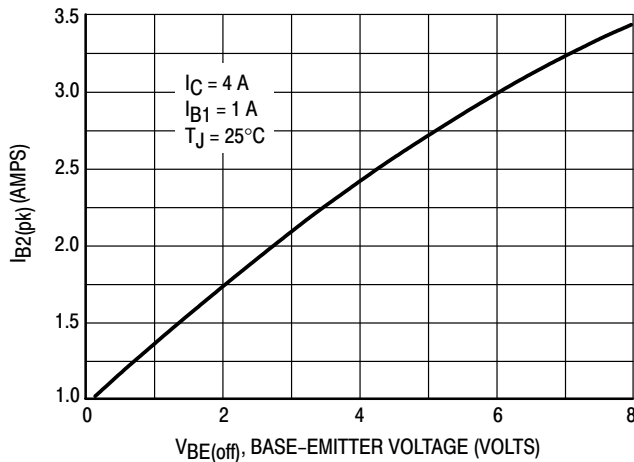

Figure 14. Peak Reverse Base Current

SAFE OPERATING AREA INFORMATION

FORWARD BIAS

There are two limitations on the power handling ability of a transistor average junction temperature and second breakdown. Safe operating area curves indicate $I_C - V_{CE}$ limits of the transistor that must be observed for reliable operation, i.e., the transistor must not be subjected to greater dissipation than the curves indicate.

The data of Figure 12 is based on $T_C = 25^\circ\text{C}$; $T_J(pk)$ is variable depending on power level. Second breakdown pulse limits are valid for duty cycles to 10% but must be derated when $T_C \geq 25^\circ\text{C}$. Second breakdown limitations do not derate the same as thermal limitations. Allowable current at the voltages shown on Figure 12 may be found at any case temperature by using the appropriate curve on Figure 15.

$T_J(pk)$ may be calculated from the data in Figure 11. At high case temperatures, thermal limitations will reduce the power that can be handled to values less than the limitations imposed by second breakdown.

REVERSE BIAS

For inductive loads, high voltage and high current must be sustained simultaneously during turn-off, in most cases, with the base to emitter junction reverse biased. Under these conditions the collector voltage must be held to a safe level at or below a specific value of collector current. This can be accomplished by several means such as active clamping, RC snubbing, load line shaping, etc. The safe level for these devices is specified as Reverse Bias Safe Operating Area and represents the voltage-current condition allowable during reverse biased turn-off. This rating is verified under clamped conditions so that the device is never subjected to an avalanche mode. Figure 13 gives the RBSOA characteristics.

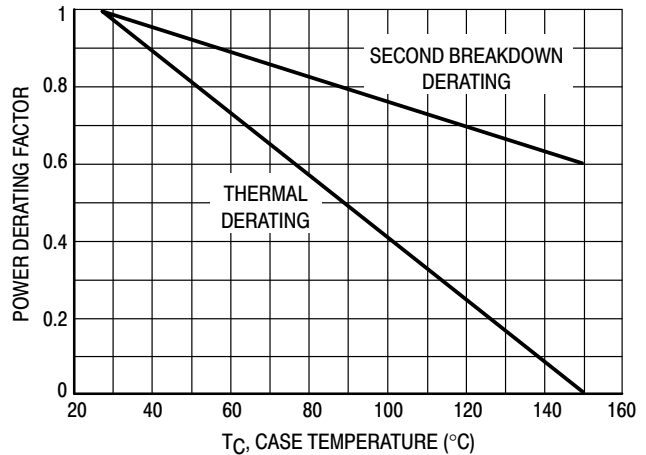
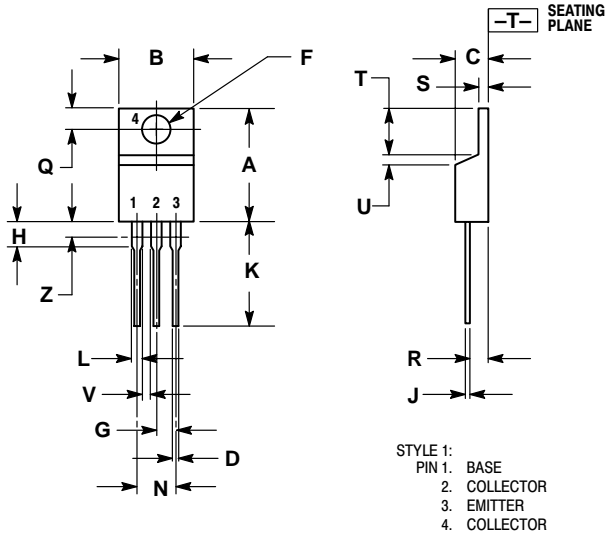

Figure 15. Forward Bias Power Derating

MJE5850 MJE5851 MJE5852

PACKAGE DIMENSIONS

TO-220AA CASE 221A-09 ISSUE AA



- NOTES:
1. DIMENSIONING AND TOLERANCING PER ANSI Y14.5M, 1982.
 2. CONTROLLING DIMENSION: INCH.
 3. DIMENSION Z DEFINES A ZONE WHERE ALL BODY AND LEAD IRREGULARITIES ARE ALLOWED.

DIM	INCHES		MILLIMETERS	
	MIN	MAX	MIN	MAX
A	0.570	0.620	14.48	15.75
B	0.380	0.405	9.66	10.28
C	0.160	0.190	4.07	4.82
D	0.025	0.035	0.64	0.88
F	0.142	0.147	3.61	3.73
G	0.095	0.105	2.42	2.66
H	0.110	0.155	2.80	3.93
J	0.018	0.025	0.46	0.64
K	0.500	0.562	12.70	14.27
L	0.045	0.060	1.15	1.52
N	0.190	0.210	4.83	5.33
Q	0.100	0.120	2.54	3.04
R	0.080	0.110	2.04	2.79
S	0.045	0.055	1.15	1.39
T	0.235	0.255	5.97	6.47
U	0.000	0.050	0.00	1.27
V	0.045	---	1.15	---
Z	---	0.080	---	2.04

SWITCHMODE is a trademark of Semiconductor Components Industries, LLC.

ON Semiconductor and  are registered trademarks of Semiconductor Components Industries, LLC (SCILLC). SCILLC reserves the right to make changes without further notice to any products herein. SCILLC makes no warranty, representation or guarantee regarding the suitability of its products for any particular purpose, nor does SCILLC assume any liability arising out of the application or use of any product or circuit, and specifically disclaims any and all liability, including without limitation special, consequential or incidental damages. "Typical" parameters which may be provided in SCILLC data sheets and/or specifications can and do vary in different applications and actual performance may vary over time. All operating parameters, including "Typicals" must be validated for each customer application by customer's technical experts. SCILLC does not convey any license under its patent rights nor the rights of others. SCILLC products are not designed, intended, or authorized for use as components in systems intended for surgical implant into the body, or other applications intended to support or sustain life, or for any other application in which the failure of the SCILLC product could create a situation where personal injury or death may occur. Should Buyer purchase or use SCILLC products for any such unintended or unauthorized application, Buyer shall indemnify and hold SCILLC and its officers, employees, subsidiaries, affiliates, and distributors harmless against all claims, costs, damages, and expenses, and reasonable attorney fees arising out of, directly or indirectly, any claim of personal injury or death associated with such unintended or unauthorized use, even if such claim alleges that SCILLC was negligent regarding the design or manufacture of the part. SCILLC is an Equal Opportunity/Affirmative Action Employer.

PUBLICATION ORDERING INFORMATION

Literature Fulfillment:

Literature Distribution Center for ON Semiconductor
P.O. Box 5163, Denver, Colorado 80217 USA
Phone: 303-675-2175 or 800-344-3860 Toll Free USA/Canada
Fax: 303-675-2176 or 800-344-3867 Toll Free USA/Canada
Email: ONlit@hibbertco.com

N. American Technical Support: 800-282-9855 Toll Free USA/Canada

JAPAN: ON Semiconductor, Japan Customer Focus Center
4-32-1 Nishi-Gotanda, Shinagawa-ku, Tokyo, Japan 141-0031
Phone: 81-3-5740-2700
Email: r14525@onsemi.com

ON Semiconductor Website: <http://onsemi.com>

For additional information, please contact your local Sales Representative.