

Miniature Aluminum Electrolytic Capacitors

NRWY Series

RADIAL LEAD, POLARIZED, EXTENDED TEMPERATURE

FEATURES

- HIGH CAPACITANCE (TO 22,000 μ F)
- HIGH VOLTAGE (TO 450Vdc)
- REDUCED SIZE

**RoHS
Compliant**
includes all homogeneous materials

*See Part Number System for Details

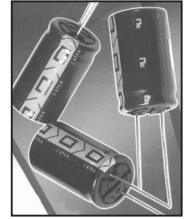

CHARACTERISTICS

Rated Voltage Range		6.3 ~ 100VDC				160 ~ 250Vdc			350 ~ 450Vdc			
Capacitance Range		0.1 ~ 22,000 μ F				0.47 ~ 330 μ F			0.47 ~ 100 μ F			
Operating Temperature Range		-55°C ~ +105°C				-40°C ~ +105°C			-25°C ~ +105°C			
Capacitance Tolerance		±20% (M)										
Maximum Leakage Current		0.01CV or 3 μ A whichever is greater after 2 min.				0.1CV +40 μ A after 1 min. 0.03CV +15 μ A after 5 min.			0.04CV +100 μ A after 1 min. 0.02CV +25 μ A after 5 min.			
Max. Tan δ at 120Hz/20°C	W.V. (Vdc)	6.3	10	16	25	35	50	63	100	160~250	350~450	
	S.V. (Vdc)	8	13	20	32	44	63	79	125	-	-	
	C \leq 1,000 μ F	0.26	0.22	0.18	0.16	0.14	0.12	0.10	0.08	0.20	0.24	
	C = 2,200 μ F	0.28	0.24	0.20	0.18	0.16	0.14	0.12	-	-	-	
	C = 3,300 μ F	0.30	0.26	0.22	0.20	0.18	0.16	-	-	-	-	
	C = 4,700 μ F	0.32	0.28	0.24	0.22	0.20	-	-	-	-	-	
	C = 6,800 μ F	0.36	0.32	0.28	0.26	-	-	-	-	-	-	
	C = 10,000 μ F	0.44	0.40	0.36	-	-	-	-	-	-	-	
Low Temperature Stability Impedance Ratio @ 120Hz	Z-25°C/Z+20°C	4	3	2	2	2	2	2	2	3	6	
	Z-55°C/Z+20°C	8	6	4	4	3	3	3	3	-	-	
Load Life Test @ 105°C	Duration	ϕ D \leq 8: 1,000 hours, ϕ D \geq 10: 2,000 hours, ϕ D \geq 12.5: 3,000 hours										
	Δ Capacitance	Within \pm 25% of initial measured value										
	Δ Tan δ	Less than 200% of specified value										
	Δ LC	Less than specified value										

STANDARD PRODUCT AND CASE SIZE TABLE D ϕ x L (mm)

Capacitance (μ F)	Code	Working Voltage (Vdc)							
		6.3	10	16	25	35	50	63	
0.10	R10	-	-	-	-	-	5 x 11	-	
0.15	R15	-	-	-	-	-	5 x 11	-	
0.22	R22	-	-	-	-	-	5 x 11	-	
0.33	R33	-	-	-	-	-	5 x 11	-	
0.47	R47	-	-	-	-	-	5 x 11	-	
1.0	1R0	-	-	-	-	-	5 x 11	-	
2.2	2R2	-	-	-	-	-	5 x 11	-	
3.3	3R3	-	-	-	-	-	5 x 11	-	
4.7	4R7	-	-	-	-	-	5 x 11	-	
10	100	-	-	-	-	-	5 x 11	5 x 11	
22	220	-	-	-	-	5 x 11	5 x 11	5 x 11	
33	330	-	-	-	5 x 11	5 x 11	5 x 11	6.3 x 11	
47	470	-	-	5 x 11	5 x 11	5 x 11	6.3 x 11	6.3 x 11	
100	101	5 x 11	5 x 11	5 x 11	6.3 x 11	6.3 x 11	8 x 11.5	10 x 12.5	
220	221	5 x 11	6.3 x 11	6.3 x 11	8 x 11.5	10 x 12.5	10 x 12.5	10 x 16	
330	331	6.3 x 11	6.3 x 11	8 x 11.5	10 x 12.5	10 x 12.5	10 x 16	10 x 20	
470	471	6.3 x 11	8 x 11.5	8 x 11.5	10 x 12.5	10 x 16	10 x 20	12.5 x 20	
1000	102	8 x 11.5	10 x 12.5	10 x 16	10 x 20	12.5 x 20	12.5 x 25	16 x 25	
2200	222	10 x 16	10 x 20	12.5 x 20	12.5 x 25	16 x 25	16 x 35.5	18 x 35.5	
3300	332	10 x 20	12.5 x 20	12.5 x 25	16 x 25	16 x 35.5	18 x 35.5	-	
4700	472	12.5 x 20	12.5 x 25	16 x 25	16 x 31.5	18 x 35.5	-	-	
6800	682	12.5 x 25	16 x 25	16 x 31.5	18 x 35.5	-	-	-	
10000	103	16 x 25	16 x 35.5	18 x 35.5	-	-	-	-	
15000	153	16 x 35.5	18 x 35.5	-	-	-	-	-	
22000	223	18 x 40	-	-	-	-	-	-	

PRECAUTIONS

Please review the notes on correct use, safety and precautions found on pages T10 & T11 of NIC's Electrolytic Capacitor catalog.
Also found at www.niccomp.com/precautions
If in doubt or uncertainty, please review your specific application - process details with NIC's technical support personnel: tpmg@niccomp.com



STANDARD PRODUCT AND CASE SIZE TABLE D ϕ x L (mm)

Capacitance (μ F)	Code	Working Voltage (Vdc)						
		100	160	200	250	350	400	450
0.47	R47	5 x 11	-	-	6.3 x 11	6.3 x 11	-	-
1.0	1R0	5 x 11	-	-	6.3 x 11	6.3 x 11	6.3 x 11	8 x 11.5
2.2	2R2	5 x 11	-	-	6.3 x 11	8 x 11.5	10 x 12.5	10 x 12.5
3.3	3R3	5 x 11	-	6.3 x 11	8 x 11.5	10 x 12.5	10 x 12.5	10 x 16
4.7	4R7	5 x 11	6.3 x 11	8 x 11.5	8 x 11.5	10 x 12.5	10 x 16	10 x 20
10	100	5 x 11	8 x 11.5	10 x 12.5	10 x 16	10 x 20	12.5 x 20	12.5 x 20
22	220	6.3 x 11	10 x 16	10 x 20	12.5 x 20	12.5 x 25	12.5 x 25	16 x 25
33	330	8 x 11.5	10 x 20	12.5 x 20	12.5 x 20	16 x 25	16 x 25	16 x 31.5
47	470	10 x 12.5	12.5 x 20	12.5 x 20	12.5 x 25	16 x 31.5	16 x 31.5	16 x 35.5
100	101	10 x 20	12.5 x 25	16 x 25	16 x 31.5	18 x 40	18 x 40	-
220	221	12.5 x 25	16 x 35.5	18 x 35.5	-	-	-	-
330	331	12.5 x 25	18 x 35.5	-	-	-	-	-
470	471	16 x 25	-	-	-	-	-	-
1000	102	18 x 40	-	-	-	-	-	-

LEAD SPACING AND DIAMETER (mm)

Case Dia. (D ϕ)	5	6.3	8	10	12.5	16	18
Lead Dia. (D ϕ)	0.5	0.5	0.6	0.6	0.6	0.8	0.8
Lead Spacing (F)	2.0	2.5	3.5	5.0	5.0	7.5	7.5
Dim. α	0.5	0.5	0.5	0.5	0.5	0.5	0.5

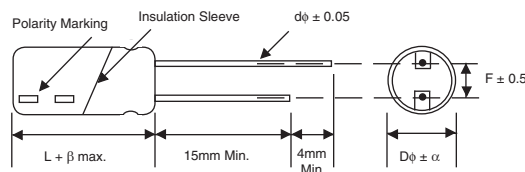

Drawing is representative of parts as supplied in bulk or straight lead format, please see taping specification for details on taped format packaging.

$$\beta = D \leq 16\text{mm} = 1.5\text{mm}, L > 16\text{mm} = 2.0\text{mm}$$

STANDARD VALUES, SPECIFICATIONS AND CASE SIZES (mm)

Part Number	Cap. (μ F)	W.V. (Vdc)	Dissipation Factor +20°C/120Hz	Ripple Current Rating (mA) +105°C/120Hz	Max. ESR (Ω) +20°C/120Hz	Load Life Hours @ +105°C	
NRWY101M6.3V5 x 11F	100	6.3	0.26	96	4.31	1,000	
NRWY221M6.3V5 x 11F	220		0.26	160	1.96	1,000	
NRWY331M6.3V6.3 x 11F	330		0.26	210	1.31	1,000	
NRWY471M6.3V6.3 x 11F	470		0.26	275	0.92	1,000	
NRWY102M6.3V8 x 11.5F	1000		0.26	460	0.43	1,000	
NRWY222M6.3V10 x 16F	2200		0.28	775	0.21	2,000	
NRWY332M6.3V10 x 20F	3300		0.30	985	0.15	2,000	
NRWY472M6.3V12.5 x 20F	4700		0.32	1150	0.11	3,000	
NRWY682M6.3V12.5 x 25F	6800		0.36	1480	0.09	3,000	
NRWY103M6.3V16 x 25F	10000		0.44	1700	0.07	3,000	
NRWY153M6.3V16 x 35.5F	15000		0.54	2090	0.06	3,000	
NRWY223M6.3V18 x 40F	22000		0.68	2360	0.05	3,000	
NRWY101M10V5 x 11F	100		10	0.22	105	3.65	1,000
NRWY221M10V6.3 x 11F	220	0.22		175	1.66	1,000	
NRWY331M10V6.3 x 11F	330	0.22		235	1.11	1,000	
NRWY471M10V8 x 11.5F	470	0.22		295	0.78	1,000	
NRWY102M10V10 x 12.5F	1000	0.22		540	0.36	2,000	
NRWY222M10V10 x 20F	2200	0.24		860	0.18	2,000	
NRWY332M10V12.5 x 20F	3300	0.26		1100	0.13	3,000	
NRWY472M10V12.5 x 25F	4700	0.28		1350	0.10	3,000	
NRWY682M10V16 x 25F	6800	0.32		1700	0.08	3,000	
NRWY103M10V16 x 35.5F	10000	0.40		1950	0.07	3,000	
NRWY153M10V18 x 35.5F	15000	0.50		2180	0.06	3,000	
NRWY470M16V5 x 11F	47	16		0.18	80	6.35	1,000
NRWY101M16V5 x 11F	100			0.18	130	2.99	1,000
NRWY221M16V6.3 x 11F	220		0.18	220	1.36	1,000	
NRWY331M16V8 x 11.5F	330		0.18	270	0.90	1,000	
NRWY471M16V8 x 11.5F	470		0.18	375	0.64	1,000	
NRWY102M16V10 x 16F	1000		0.18	640	0.30	2,000	
NRWY222M16V12.5 x 20F	2200		0.20	1050	0.15	3,000	
NRWY332M16V12.5 x 25F	3300		0.22	1300	0.11	3,000	
NRWY472M16V16 x 25F	4700		0.24	1650	0.08	3,000	
NRWY682M16V16 x 31.5F	6800		0.28	1900	0.07	3,000	
NRWY103M16V18 x 35.5F	10000		0.36	2000	0.06	3,000	



STANDARD VALUES, SPECIFICATIONS AND CASE SIZES (mm)

Part Number	Cap. (µF)	W.V. (Vdc)	Dissipation Factor +20°C/120Hz	Ripple Current Rating (mA) +105°C/120Hz	Max. ESR (Ω) +20°C/120Hz	Load Life Hours @+105°C
NRWY330M25V5 x 11F	33	25	0.16	69	8.04	1,000
NRWY470M25V5 x 11F	47		0.16	84	5.65	1,000
NRWY101M25V6.3 x 11F	100		0.16	140	2.65	1,000
NRWY221M25V8 x 11.5F	220		0.16	240	1.21	1,000
NRWY331M25V10 x 12.5F	330		0.16	335	0.80	2,000
NRWY471M25V10 x 12.5F	470		0.16	440	0.56	2,000
NRWY102M25V10 x 20F	1000		0.16	740	0.27	2,000
NRWY222M25V12.5 x 25F	2200		0.18	1230	0.14	3,000
NRWY332M25V16 x 25F	3300		0.20	1500	0.10	3,000
NRWY472M25V16 x 31.5F	4700		0.22	1800	0.08	3,000
NRWY682M25V18 x 35.5F	6800	0.26	2050	0.06	3,000	
NRWY220M35V5 x 11F	22	35	0.14	64	10.56	1,000
NRWY330M35V5 x 11F	33		0.14	77	7.04	1,000
NRWY470M35V5 x 11F	47		0.14	100	4.94	1,000
NRWY101M35V6.3 x 11F	100		0.14	170	2.32	1,000
NRWY221M35V10 x 12.5F	220		0.14	300	1.06	2,000
NRWY331M35V10 x 12.5F	330		0.14	400	0.70	2,000
NRWY471M35V10 x 16F	470		0.14	525	0.49	2,000
NRWY102M35V12.5 x 20F	1000		0.14	865	0.23	3,000
NRWY222M35V16 x 25F	2200		0.16	1370	0.12	3,000
NRWY332M35V16 x 35.5F	3300		0.18	1680	0.09	3,000
NRWY472M35V18 x 35.5F	4700	0.20	1920	0.07	3,000	
NRWYR10M50V5 x 11F	0.10	50	0.12	1.0	1990.4	1,000
NRWYR15M50V5 x 11F	0.15		0.12	1.5	904.7	1,000
NRWYR22M50V5 x 11F	0.22		0.12	2.5	603.1	1,000
NRWYR33M50V5 x 11F	0.33		0.12	4	423.5	1,000
NRWYR47M50V5 x 11F	0.47		0.12	7	199.0	1,000
NRWY1R0M50V5 x 11F	1.0		0.12	13	90.47	1,000
NRWY2R2M50V5 x 11F	2.2		0.12	20	60.32	1,000
NRWY3R3M50V5 x 11F	3.3		0.12	25	42.35	1,000
NRWY4R7M50V5 x 11F	4.7		0.12	32	19.90	1,000
NRWY100M50V5 x 11F	10		0.12	47	9.05	1,000
NRWY220M50V5 x 11F	22		0.12	70	6.03	1,000
NRWY330M50V5 x 11F	33		0.12	94	4.23	1,000
NRWY470M50V6.3 x 11F	47		0.12	115	1.99	1,000
NRWY101M50V8 x 11.5F	100		0.12	200	0.90	1,000
NRWY221M50V10 x 12.5F	220		0.12	360	0.60	2,000
NRWY331M50V10 x 16F	330		0.12	470	0.42	2,000
NRWY471M50V10 x 20F	470		0.12	600	0.20	2,000
NRWY102M50V12.5 x 25F	1000		0.12	1060	0.11	3,000
NRWY222M50V16 x 35.5F	2200		0.14	1600	0.08	3,000
NRWY332M50V18 x 35.5F	3300		0.16	1780	0.03	3,000
NRWY100M63V5 x 11F	10	63	0.10	48	16.59	1,000
NRWY220M63V5 x 11F	22		0.10	80	7.54	1,000
NRWY330M63V6.3 x 11F	33		0.10	100	5.03	1,000
NRWY470M63V6.3 x 11F	47		0.10	140	3.53	1,000
NRWY101M63V10 x 12.5F	100		0.10	230	1.66	2,000
NRWY221M63V10 x 16F	220		0.10	390	0.75	2,000
NRWY331M63V10 x 20F	330		0.10	540	0.50	2,000
NRWY471M63V12.5 x 20F	470		0.10	700	0.35	3,000
NRWY102M63V16 x 25F	1000		0.10	1200	0.17	3,000
NRWY222M63V18 x 35.5F	2200		0.12	1650	0.09	3,000
NRWYR47M100V5 x 11F	0.47	100	0.08	8	282.33	1,000
NRWY1R0M100V5 x 11F	1.0		0.08	15	132.70	1,000
NRWY2R2M100V5 x 11F	2.2		0.08	21	60.32	1,000
NRWY3R3M100V5 x 11F	3.3		0.08	30	40.21	1,000
NRWY4R7M100V5 x 11F	4.7		0.08	35	28.23	1,000
NRWY100M100V5 x 11F	10		0.08	60	13.27	1,000
NRWY220M100V6.3 x 11F	22		0.08	98	6.03	1,000
NRWY330M100V8 x 11.5F	33		0.08	140	4.02	1,000



STANDARD VALUES, SPECIFICATIONS AND CASE SIZES (mm)

Part Number	Cap. (µF)	W.V. (Vdc)	Dissipation Factor +20°C/120Hz	Ripple Current Rating (mA) +105°C/120Hz	Max. ESR (Ω) +20°C/120Hz	Load Life Hours @+105°C	
NRWY470M100V10 x 12.5F	47	100	0.08	185	2.82	2,000	
NRWY1010M100V10 x 20F	100		0.08	290	1.33	2,000	
NRWY221M100V12.5 x 25F	220		0.08	560	0.60	3,000	
NRWY331M100V12.5 x 25F	330		0.08	690	0.40	3,000	
NRWY471M100V16 x 25F	470		0.08	880	0.28	3,000	
NRWY102M100V18 x 40F	1000		0.08	985	0.13	3,000	
NRWY4R7M160V6.3 x 11F	4.7	160	0.20	43	70.58	1,000	
NRWY100M160V8 x 11.5F	10		0.20	77	33.17	1,000	
NRWY220M160V10 x 16F	22		0.20	125	15.08	2,000	
NRWY330M160V10 x 20F	33		0.20	170	10.05	2,000	
NRWY470M160V12.5 x 20F	47		0.20	210	7.06	3,000	
NRWY101M160V12.5 x 25F	100		0.20	320	3.32	3,000	
NRWY221M160V16 x 35.5F	220		0.20	580	1.51	3,000	
NRWY331M160V18 x 35.5F	330		0.20	700	1.01	3,000	
NRWY3R3M200V6.3 x 11F	3.3	200	0.20	36	100.53	1,000	
NRWY4R7M200V8 x 11.5F	4.7		0.20	50	70.58	1,000	
NRWY100M200V10 x 12.5F	10		0.20	80	33.17	2,000	
NRWY220M200V10 x 20F	22		0.20	135	15.08	2,000	
NRWY330M200V12.5 x 20F	33		0.20	200	10.05	3,000	
NRWY470M200V12.5 x 20F	47		0.20	220	7.06	3,000	
NRWY101M200V16 x 25F	100		0.20	340	3.32	3,000	
NRWY221M200V18 x 35.5F	220		0.20	580	1.51	3,000	
NRWYR47M250V6.3 x 11F	0.47	250	0.20	8	705.83	1,000	
NRWY1R0M250V6.3 x 11F	1.0		0.20	16	331.74	1,000	
NRWY2R2M250V6.3 x 11F	2.2		0.20	30	150.79	1,000	
NRWY3R3M250V8 x 11.5F	3.3		0.20	43	100.53	1,000	
NRWY4R7M250V8 x 11.5F	4.7		0.20	53	70.58	1,000	
NRWY100M250V10 x 16F	10		0.20	90	33.17	2,000	
NRWY220M250V12.5 x 20F	22		0.20	150	15.08	3,000	
NRWY330M250V12.5 x 20F	33		0.20	200	10.05	3,000	
NRWY470M250V12.5 x 25F	47		0.20	240	7.06	3,000	
NRWY101M250V16 x 31.5F	100		0.20	400	3.32	3,000	
NRWYR47M350V6.3 x 11F	0.47		350	0.24	8	847.00	1,000
NRWY1R0M350V6.3 x 11F	1.0			0.24	16	398.09	1,000
NRWY2R2M350V8 x 11.5F	2.2	0.24		31	180.95	1,000	
NRWY3R3M350V10 x 12.5F	3.3	0.24		45	120.63	2,000	
NRWY4R7M350V10 x 12.5F	4.7	0.24		55	84.70	2,000	
NRWY100M350V10 x 20F	10	0.24		95	39.81	2,000	
NRWY220M350V12.5 x 25F	22	0.24		175	18.09	3,000	
NRWY330M350V16 x 25F	33	0.24		220	12.06	3,000	
NRWY470M350V16 x 31.5F	47	0.24		260	8.47	3,000	
NRWY101M400V18 x 40F	100	0.24		415	3.98	3,000	
NRWY1R0M400V6.3 x 11F	1.0	400	0.24	16	398.09	1,000	
NRWY2R2M400V10 x 12.5F	2.2		0.24	31	180.95	2,000	
NRWY3R3M400V10 x 12.5F	3.3		0.24	41	120.63	2,000	
NRWY4R7M400V10 x 16F	4.7		0.24	55	84.70	2,000	
NRWY100M400V12.5 x 20F	10		0.24	85	39.81	3,000	
NRWY220M400V12.5 x 25F	22		0.24	170	18.09	3,000	
NRWY330M400V16 x 25F	33		0.24	220	12.06	3,000	
NRWY470M400V16 x 31.5F	47		0.24	275	8.47	3,000	
NRWY101M400V18 x 40F	100		0.24	415	3.98	3,000	
NRWY1R0M450V8 x 11.5F	1.0		450	0.24	15	398.09	1,000
NRWY2R2M450V10 x 12.5F	2.2	0.24		25	180.95	2,000	
NRWY3R3M450V10 x 16F	3.3	0.24		33	120.63	2,000	
NRWY4R7M450V10 x 20F	4.7	0.24		42	84.70	2,000	
NRWY100M450V12.5 x 20F	10	0.24		67	39.81	3,000	
NRWY220M450V16 x 25F	22	0.24		115	18.09	3,000	
NRWY330M450V16 x 31.5F	33	0.24		155	12.06	3,000	
NRWY470M450V16 x 35.5F	47	0.24		185	8.47	3,000	



RIPPLE CURRENT FREQUENCY CORRECTION FACTOR

Cap. Value (μ F)	Frequency (Hz)				
	50(60)	120	500	1K	10K>
0.1 ~ 1.0	0.50	1.0	1.20	1.30	1.50
2.2 ~ 4.7	0.65	1.00	1.20	1.30	1.50
10 ~ 47	0.80	1.00	1.20	1.30	1.50
100 ~ 1000	0.80	1.00	1.10	1.15	1.20
2200 ~ 22000	0.80	1.00	1.05	1.10	1.15

PART NUMBER SYSTEM

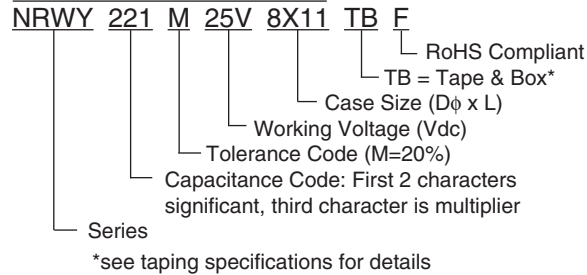

Miniature Aluminum Electrolytic Capacitors Taping Specifications

STANDARD RADIAL TAPING (5mm LEAD SPACING, FORMED LEADS) TR, TB

Taping Dimensions (mm)

Case Dia. (D ϕ)	4	5	6.3	8
Case Size	4x5 4x7	5x5 5x7	5x11	6.3x5 6.3x7 6.3x11 8x11.5
d ϕ \pm 0.05	0.45	0.45	0.5	0.45
H \pm 0.75	17.5	17.5	18.5	17.5
F $+0.8 \sim -0.2$	5.0 $-0.2 \sim +0.8$			
P	12.7 \pm 1.0			
P ₀	12.7 \pm 0.2			
P ₁	3.85 \pm 0.5 (at end of tape)			
P ₂	6.35 \pm 1.0			
W	18.0 \pm 0.5			
W ₀	11.5 min.			
W ₁	9.0 \pm 0.5			
W ₂	0 \sim 2.5			
H ₀	16.0 \pm 0.5			
l	1.0 max.			
D ₀ ϕ	4.0 \pm 0.2			
Δ h	0 \pm 1.0 (at top of can)			
t	0.7 \pm 0.2 (not including lead)			

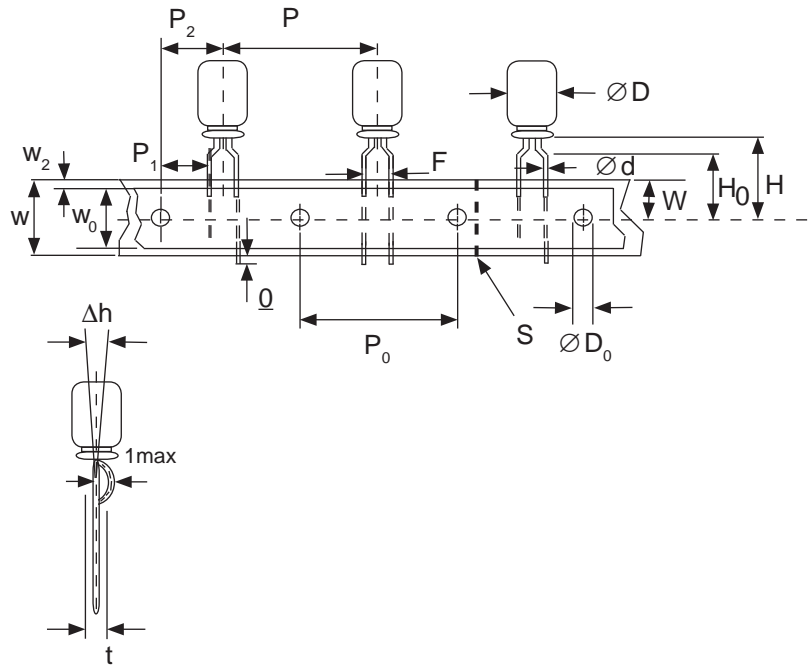

STANDARD RADIAL TAPING (5mm LEAD SPACING, STRAIGHT LEADS) TR, TB

Taping Dimensions (mm)

Case Dia. (D ϕ)	10	12.5
Case Size	All	All
d ϕ \pm 0.05	0.6	0.6
H \pm 0.75	19.0	19.0
F $+0.8 \sim -0.2$	5.0	5.0
P \pm 1.0	25.4*	
P ₀	12.7 \pm 0.2	
P ₁	3.85	
P ₂	6.35 \pm 1.0	
W	18.0 \pm 0.5	
W ₀	11.5 min	
W ₁	9.0 \pm 0.5	
W ₂	0 \sim 2.5	
H ₀	16.0 \pm 0.5	
l	1.0 max.	
D ₀ ϕ	4.0 \pm 0.2	
Δ h	0 \pm 1.0 (at top of can)	
t	0.7 \pm 0.2 (not including lead)	

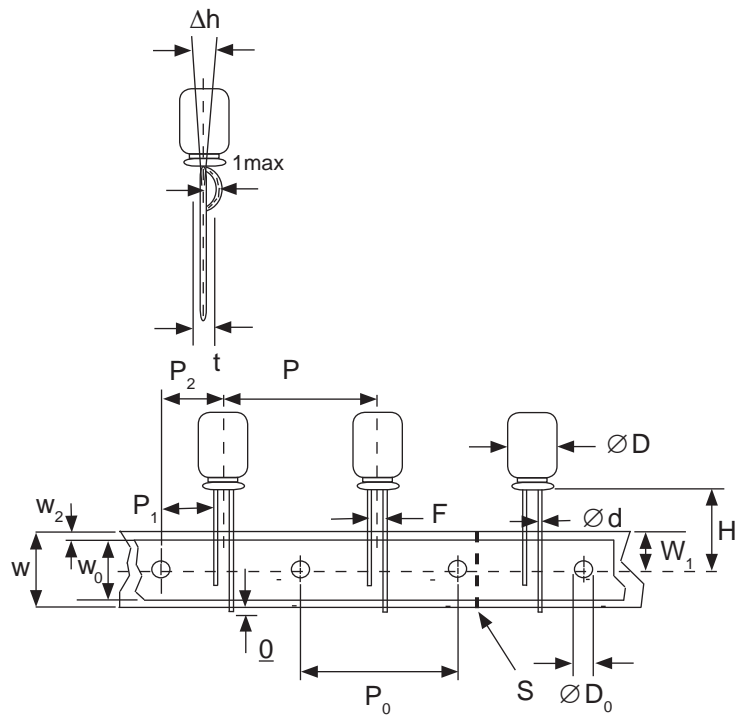

*Optional Taping Specifications

10mm diameter available with P dim. = 12.7mm
(P/N Suffix: TB12.7MMP)

12.5mm diameter available with P dim. = 15mm, P₁ = 5.0mm,
P₀ = 15.0mm & P₂ = 7.5mm (P/N Suffix: TB15MMP)

NOTE: ANODE (+) LEAD FEEDS OFF FIRST.
FOR OPTION OF NEGATIVE (-) LEAD FIRST,
SPECIFY "TRN" OR "TBN".



Miniature Aluminum Electrolytic Capacitors Taping Specifications

SPECIAL RADIAL TAPING (2.5mm LEAD SPACING, FORMED LEADS) TRF1, TBF1

Taping Dimensions (mm)

Case Dia. (D ϕ)	4		5	
Case Size Dim.	4x5 4x7	5x5 5x7	5x11	
d ϕ \pm 0.05	0.45	0.45	0.5	
H \pm 0.75	17.5	17.5	18.5	
H ₀ \pm 0.5	16.0	-	-	
F	2.5 -0.2 ~ +0.8			
P	12.7 \pm 1.0			
P ₀	12.7 \pm 0.2			
P ₁	5.1 \pm 0.5			
P ₂	6.35 \pm 1.0			
W	18.0 \pm 0.5			
W ₀	11.5 min.			
W ₁	9.0 \pm 0.5			
W ₂	0 ~ 1.5			
l	1.0 max.			
D ₀ ϕ	4.0 \pm 0.2			
Δ h	0 \pm 1.0			
t	0.7 \pm 0.2			

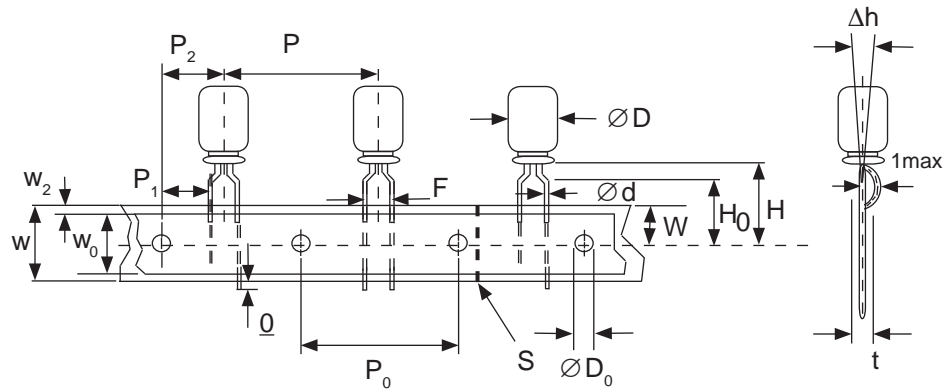

SPECIAL STRAIGHT LEAD TAPING TRST, TBST

Taping Dimensions (mm)

Case Dia. (D ϕ)	4			5			6.3		8	
Case Size Dim.	4x5 4x7	5x5 5x7	5x11		6.3x5 6.3x7	6.3x11	8x11.5			
d ϕ \pm 0.05	0.45	0.45	0.5		0.45	0.5	0.6			
H \pm 0.75	17.5	17.5	18.5		17.5	18.5	20.0			
F +0.8 ~ -0.2	2.0*	2.0	2.0		2.5	2.5	3.5			
P \pm 1.0	12.7 \pm 0.2									
P ₀	12.7 \pm 0.2									
P ₁	5.1	5.1	5.1	5.1	5.1	5.1	4.6			
P ₂	6.35 \pm 1.0									
W	18.0 \pm 0.5									
W ₀	11.5 min.									
W ₁	9.0 \pm 0.5									
W ₂	0 ~ 2.5									
H ₀	16.0 \pm 0.5									
l	1.0 max.									
D ₀ ϕ	4.0 \pm 0.2									
Δ h	0 \pm 1.0 (at top of can)									
t	0.7 \pm 0.2 (not including lead)									

* Parts with 4mm diameter are taped with a slight flare in the lead and a 2.0mm lead-space.

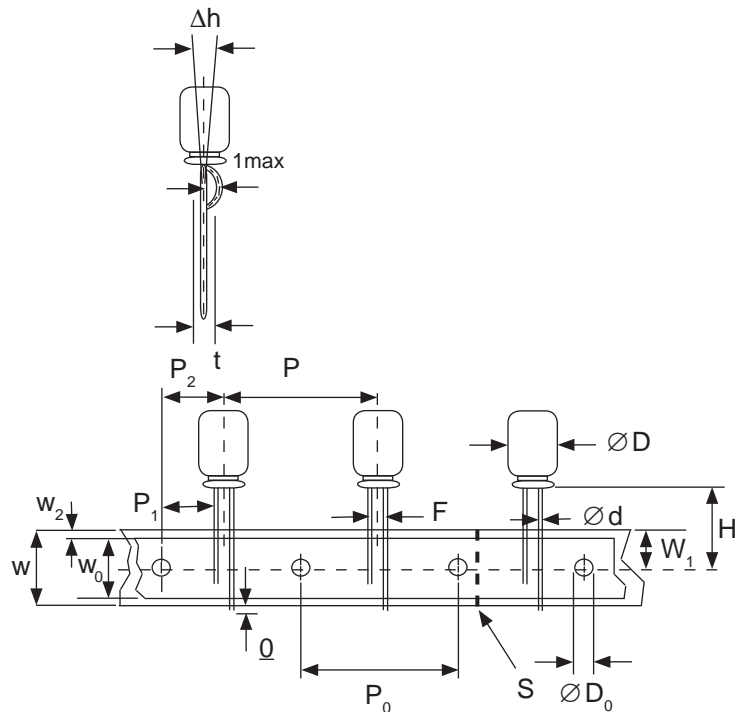

Miniature Aluminum Electrolytic Capacitors Taping Specifications

RADIAL TAPED PACKAGING

Ammo Box (Tape & Box) TB, TBF, TBST

Size of box and component quantity

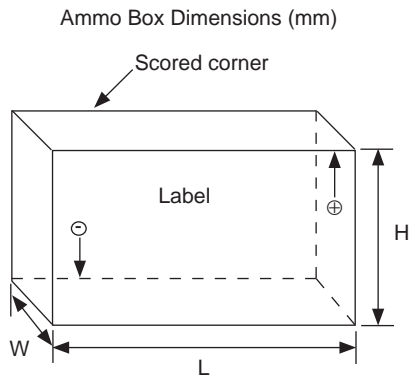

Case Dia (D ϕ) or Case Size	Q'ty per Box (pcs)	Dim. L	Dim. H	Dim. W
4x5, 4x7	2,000	331	175	43
5x5, 5x7	2,000	331	220	43
5x11	2,000	340	255	55
6.3x5, 6.3x7	2,000	331	280	43
6.3x11	2,000	331	280	48
8x11.5, 8x12.5	1,000	335	235	53
10x12.5*	500	335	190	53
10x16*	500	335	300	53
10x20*	500	335	300	55
12.x20*	500	335	300	55
12.5x25*	500	335	300	61

*Special Taping Consult Factory For Availability

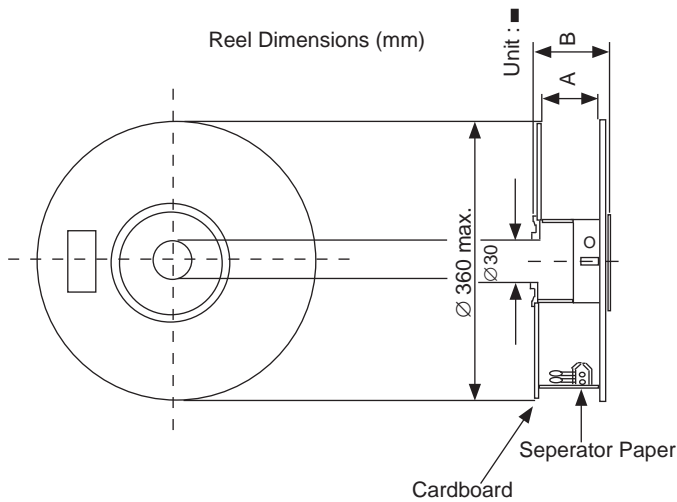

Reel Packages (Tape & Reel) TR, TRF1, TRST

Size of reel and component quantity

Case Dia (D ϕ) or Case Size	Q'ty per Box (pcs)	Dim. A	Dim. B
4 ϕ	1,800	42	52
5 ϕ	1,500	42	52
6.3 ϕ	1,000	42	52
8 ϕ	800	42	52
10x12.5*	600	42	52
10x16*	600	48	56
10x20*	600	52	60
12.x20*	250	52	60
12.5x25*	250	56	64

*Special Taping Consult Factory For Availability

