

ROHS Compliant



台灣駿品端子股份有限公司

TAIWAN KING PIN TERMINAL CO.,LTD

新北市樹林區俊德街 23 號

TEL:886-2-26895596.26886112 FAX:886-2-26886110
E-mail:info@tkp.com.tw http://www.tkp.com.tw

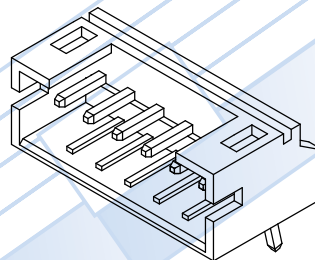

- NOTE :**
- * Material : Nylon UL 94V-0
 - * Contact : Brass
 - * Finish : Plated Tin/Lead over Nickel
 - * Electrical rating : UL 125V 1A, AC/DC
CSA 250V 1A, AC/DC
 - * Standard color: White or Orange
 - * .020" (0.5mm) straight square pins
 - * Mates with H110 series housings
 - * 2-16 circuits available

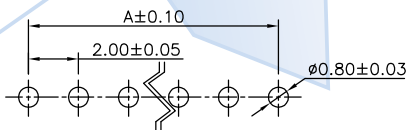
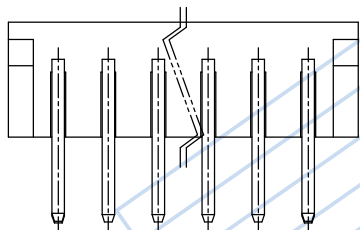
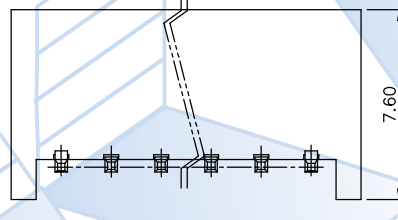
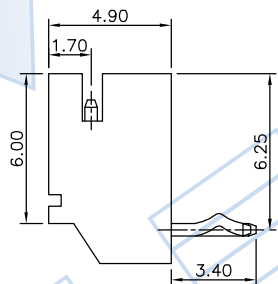
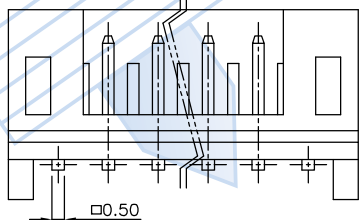
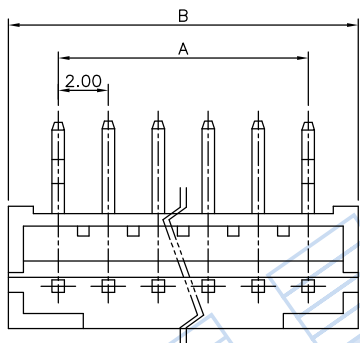

RECOMMENDED PCB LAYOUT



Circuits	Part No.	Dim. A	Dim. B	Circuits	Part No.	Dim. A	Dim. B
2	P110L-02	2.00	6.00	9	P110L-09	16.00	20.00
3	P110L-03	4.00	8.00	10	P110L-10	18.00	22.00
4	P110L-04	6.00	10.00	11	P110L-11	20.00	24.00
5	P110L-05	8.00	12.00	12	P110L-12	22.00	26.00
6	P110L-06	10.00	14.00	13	P110L-13	24.00	28.00
7	P110L-07	12.00	16.00	14	P110L-14	26.00	30.00
8	P110L-08	14.00	18.00	15	P110L-15	28.00	32.00



PART NO.	P110L-XX			Part NO.	Material	Color/Finish	Remark	APPROVAL
TITLE	2.00mm Wire to Board			P110L-XX	Nylon UL 94V-0	White		DRAWN: 高瑋瑩
THIRD ANGLE	SCALE	UNIT	SHEET NO	P110L-XX-O	Nylon UL 94V-0	Orange		CHECKED: 張明遠
	2.5:1	mm	1/1	TOLERANCE	DATE	ODD NUMBERS	REV	APPROVED: 陳泓宇
	200-051		A200-012	.X± 0.30 .XXX±0.10 .XX± 0.20	2012.05.22	ENG951387	A3	
				ANGLE±2°				