

ROHS Compliant

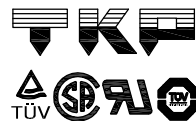

# 台灣駿品端子股份有限公司

TAIWAN KING PIN TERMINAL CO.,LTD

新北市樹林區俊德街 23 號

TEL:886-2-26895596.26886112 FAX:886-2-26886110  
E-mail:info@tkp.com.tw http://www.tkp.com.tw

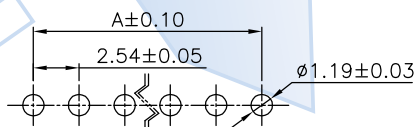
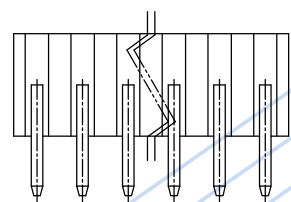
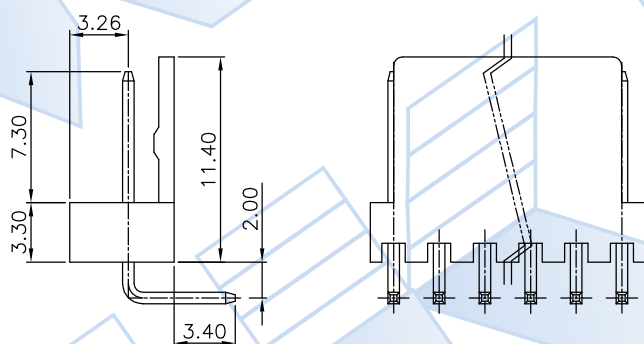
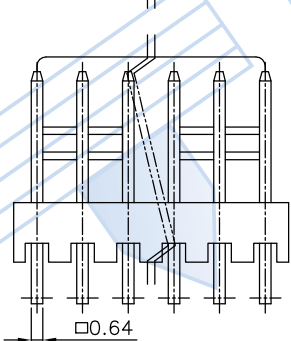
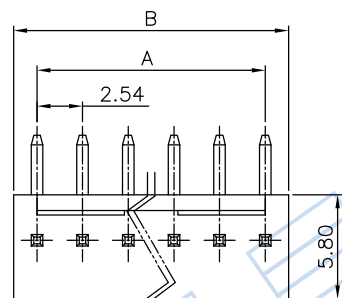

RECOMMENDED PCB LAYOUT

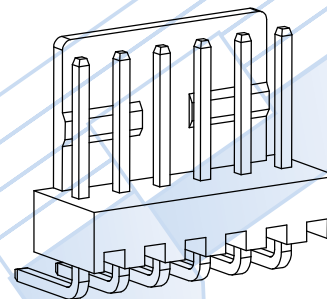

NOTE :

- \* Material : Nylon UL 94V-2(Lead Free)
- \* Standard Color : White
- \* Contact : Brass
- \* Finish : Plated Tin over Nickel
- \* Electrical rating : UL 250V 2A, AC/DC
- \* .025" (0.64mm) right angle square pins
- \* Mates with 2510,2510A,2510B,2510F series housings
- \* Friction lock
- \* 2-20 circuits available



Circuits	Part No.	Dim. A	Dim. B	Circuits	Part No.	Dim. A	Dim. B
2	P2510L-02(LF)	2.54	5.08	12	P2510L-12(LF)	27.94	30.48
3	P2510L-03(LF)	5.08	7.62	13	P2510L-13(LF)	30.48	33.02
4	P2510L-04(LF)	7.62	10.16	14	P2510L-14(LF)	33.02	35.56
5	P2510L-05(LF)	10.16	12.70	15	P2510L-15(LF)	35.56	38.10
6	P2510L-06(LF)	12.70	15.24	16	P2510L-16(LF)	38.10	40.64
7	P2510L-07(LF)	15.24	17.78	17	P2510L-17(LF)	40.64	43.18
8	P2510L-08(LF)	17.78	20.32	18	P2510L-18(LF)	43.18	45.72
9	P2510L-09(LF)	20.32	22.86	19	P2510L-19(LF)	45.72	48.26
10	P2510L-10(LF)	22.86	25.40	20	P2510L-20(LF)	48.26	50.80
11	P2510L-11(LF)	25.40	27.94				



PART NO.	P2510L-XX(LF)	Part NO.	Material	Color/Finish	Remark	APPROVAL
TITLE	2.54mm Wire to Board					DRAWN: 高琇瑩
THIRD ANGLE	SCALE UNIT SHEET NO	TOLERANCE	DATE	ODD NUMBERS	REV	CHECKED: 張明遠
	2:1 mm 1/1	.X± 0.30 .XXX±0.10 .XX± 0.20 ANGLE±2°	2012.05.11	ENG951382	A2	APPROVED: 陳泓宇
	254-117	A254-009				