

ROHS Compliant



台灣駿品端子股份有限公司

TAIWAN KING PIN TERMINAL CO.,LTD

台北縣樹林市俊德街 23 號

TEL:886-2-26895596.26886112 FAX:886-2-26886110

E-mail:info@tkp.com.tw

http://www.tkp.com.tw

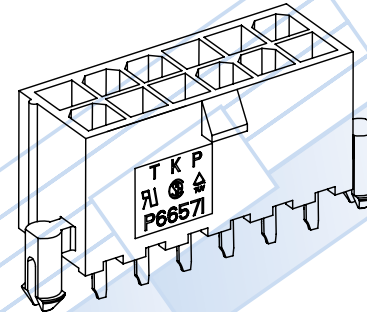
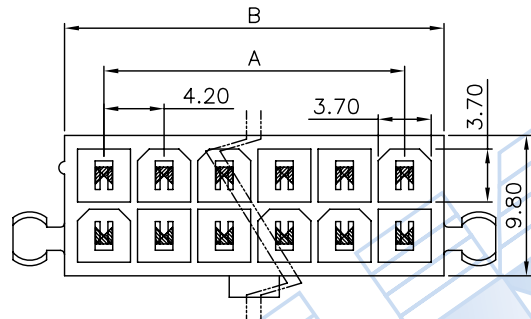

NOTE :

- \* Material : Nylon UL 94V-2 or UL 94V-0
- \* Color : Natural or White
- \* Contact : Brass
- \* Finish: Plated Tin or Gold over Nickel
- \* Electrical rating : UL 250V 5A , AC/DC  
CSA 250V 4A , AC/DC  
TUV 250V 7A, AC/DC

- \* Positive housing locks
- \* Split pins with pegs
- \* Mates with H6657R1 receptacle housings
- \* Dual row , 2-24 circuits available

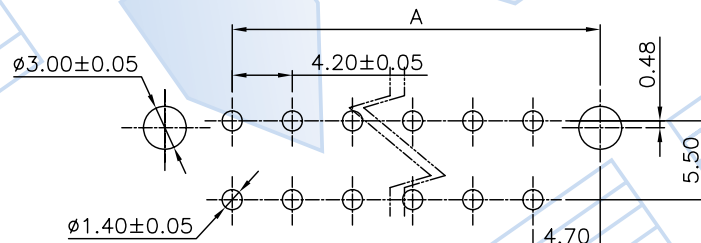
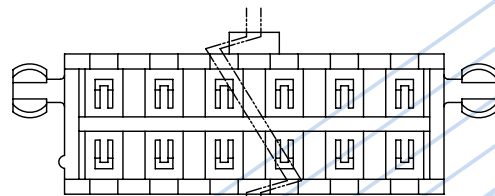
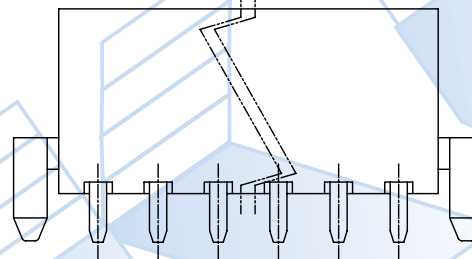
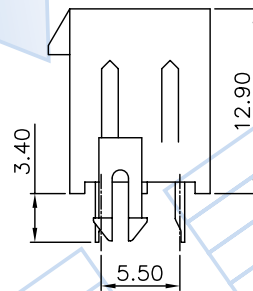
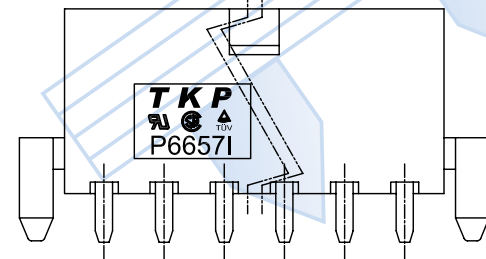

RECOMMENDED PCB LAYOUT

Circuits	PART NO.	Dim. A	Dim. B	Circuits	PART NO.	Dim. A	Dim. B
2	P66571-02A	—	5.50	14	P66571-14A	25.20	30.70
4	P66571-04A	4.20	9.70	16	P66571-16A	29.40	34.90
6	P66571-06A	8.40	13.90	18	P66571-18A	33.60	39.10
8	P66571-08A	12.60	18.10	20	P66571-20A	37.80	43.30
10	P66571-10A	16.80	22.30	22	P66571-22A	42.00	47.50
12	P66571-12A	21.00	26.50	24	P66571-24A	46.20	51.70



PART NO.	P6657I-XXA(LF)				Part NO.	Material	Color/Finish	Remark	APPROVAL
TITLE	4.20mm Wire to Wire				P6657I-XXA(LF)	Nylon UL 94V-2	Natural / Tin		DRAWN: 張明遠
THIRD ANGLE	SCALE	UNIT	SHEET NO	TOLERANCE	DATE	ODD NUMBERS	REV	CHECKED: 高琇瑩	
	1.25:1	mm	1/1	.X± 0.30 .XXX±0.10 .XX± 0.20 ANGLE±2°	2008.02.29	TW107	A1	APPROVED: 陳泓宇	
	420-023		C420-004						