

ROHS Compliant



# 台灣駿品端子股份有限公司

TAIWAN KING PIN TERMINAL CO.,LTD

台北縣樹林市俊德街 23 號

TEL:886-2-26895596.26886112 FAX:886-2-26886110

E-mail:info@tkp.com.tw

http://www.tkp.com.tw

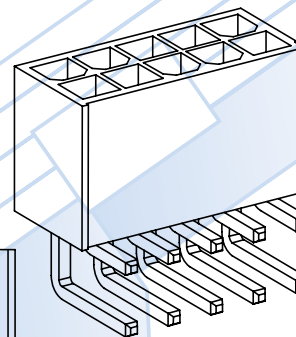
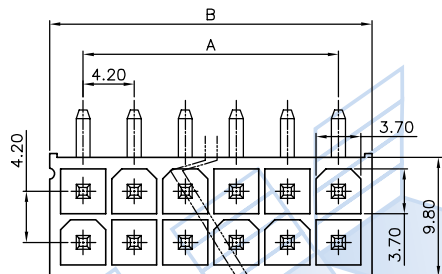

**NOTE**

- \* Material : Nylon UL 94V-2 or 94V-0
- \* Standard color : Natural or Black
- \* Contact : Brass
- \* Finish: Plated Tin over Nickel
- \* Electrical rating : UL 250V 5A , AC/DC  
CSA 250V 4A , AC/DC  
TUV 250V 7A , AC/DC
- \* Positive housing locks
- \* W/O flange & peg
- \* Mates with H6657R1 receptacle housings
- \* Dual row , 2-24 circuits available

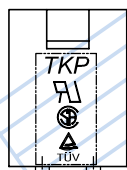

P6657L-XX-02-04

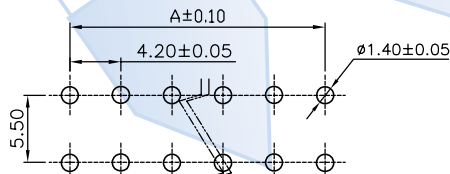
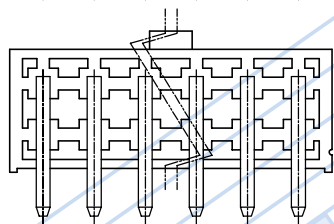
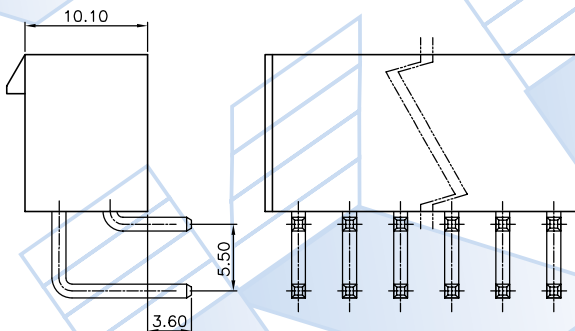
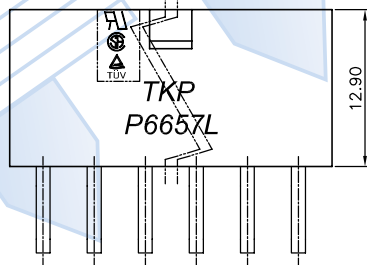

Part NO.	Material	Color
P6657L-XX	94V-2	Natural
P6657L-XX/B	94V-2	Black
P6657L-XX-6T	94V-0	Natural
P6657L-XX-V0	94V-0	Natural



Circuits	Part No.	Dim. A	Dim. B	Circuits	Part No.	Dim. A	Dim. B
2	P6657L-02	—	5.50	14	P6657L-14	25.20	30.70
4	P6657L-04	4.20	9.70	16	P6657L-16	29.40	34.90
6	P6657L-06	8.40	13.90	18	P6657L-18	33.60	39.10
8	P6657L-08	12.60	18.10	20	P6657L-20	37.80	43.30
10	P6657L-10	16.80	22.30	22	P6657L-22	42.00	47.50
12	P6657L-12	21.00	26.50	24	P6657L-24	46.20	51.70



PART NO.	P6657L-XX			Part NO.	Material	Color	Remark	APPROVAL
TITLE	4.20mm Wire to Wire			如上表				DRAWN: 詹雅茹
THIRD ANGLE	SCALE	UNIT	SHEET NO	TOLERANCE	DATE	ODD NUMBERS	REV	CHECKED: 詹雅茹
	1.5:1	mm	1/1	.X± 0.30 .XX±0.10 .XX± 0.20 ANGLE±2°	2009.02.10	ENG950281	A3	APPROVED: 陳泓宇
	420-031		C420-006					