



FEATURES

- Carbon resistive element.
- IP54 protection according to IEC 60529.
- Polyester substrate.
- SMD version available (see PS-6 datasheet).
- Also upon request:
 - Wiper positioned at 50% or fully clockwise
 - Supplied in magazines for automatic insertion
 - Long life model (10K cycles)
 - Housing available in self extinguishable plastic (UL94V0)
 - Mechanical detents

MECHANICAL SPECIFICATIONS

- Mechanical Rotation angle: $235^\circ \pm 5^\circ$
- Electrical Rotation angle: $200^\circ \pm 20^\circ$
- Torque: 0.2 to 2 Ncm. (0.3 to 2.7 in-oz)
- Stop torque: > 4 Ncm. (> 5.6 in-oz)
- Life*: Up to 10K cycles

ELECTRICAL SPECIFICATIONS

- Range of values*
 $220\Omega \leq R_n \leq 5M$ (Decad. 1.0 - 2.0 - 2.2 - 2.5 - 4.7 - 5.0)
- Tolerance*: $220\Omega \leq R_n \leq 1M\Omega$ $\pm 20\%$
 $1M\Omega < R_n \leq 5M\Omega$ $\pm 30\%$
- Max. Voltage: 100 VDC (lin), 50 VDC (no lin)
- Nominal Power 50°C (122°F) (see power rating curve)
 0.1 W (lin) 0.05 W (no lin)
- Taper*: Lin; Log; Alog (Log & Alog. only $R_n \geq 1K$)
- Residual resistance*: $\leq 0.5\%$ R_n (5 Ω min)
- Equivalent Noise Resistance: $\leq 3\%$ R_n (3 Ω min)
- Operating Temperature**: $-25^\circ C$ $+70^\circ C$ ($-13^\circ F$ $+158^\circ F$)

* Others upon request.

** Up to 85°C depending on application

HOW TO ORDER

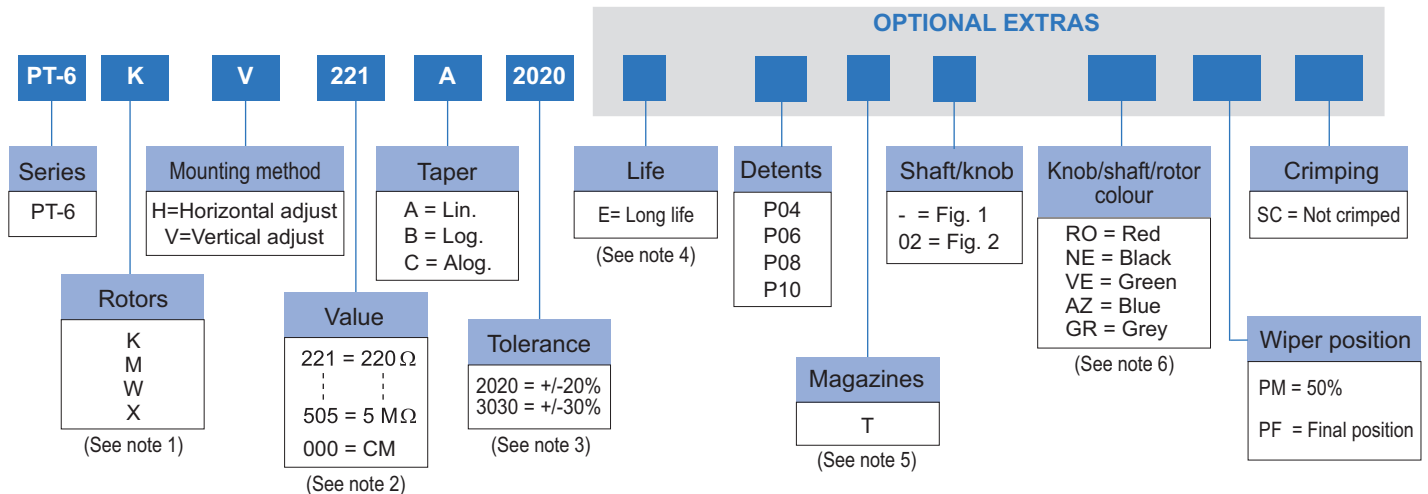

NOTES:

(1) Adjust. type: «X» is only available with horizontal adjusting method.

(2) Value: - Code: $\frac{22}{1} = 220\Omega$
 - 000 = CM = Switch version (contact us)
 Number of zeros First two digits.

(3) Tolerance (non standard): Upon request..... Code eg.: $\frac{+7}{-5} = \frac{07}{05}$
 Negative tolerance Positive tolerance

(4) Life: • Standard = 200 cycles • Long = 10K cycles (non-detented models)

(5) Only for "V" mounting method. "W" rotor with shaft Fig. 2 is not available in magazines.

(6) Potentiometer without knob or shaft, only the rotor. Potentiometer with knob or shaft, only the knob/shaft. Default colour for knob/shaft is cream. Shaft only available in cream or black colour.

NOTE: The information contained here should be used for reference purposes only.

HOW TO ORDER CUSTOM DRAWING

PT-6 KV + DRAWING NUMBER (Max. 16 characters)

This way of ordering should be used for options which are not included in the "How to order" standard and optional extras.

STANDARD OPTIONS

Packing	Bulk
Rotor colour	White
Wiper position	Initial
Crimping	Yes
Knob/Shaft colour	Cream
Mechanical life	200 cycles

ROTORS

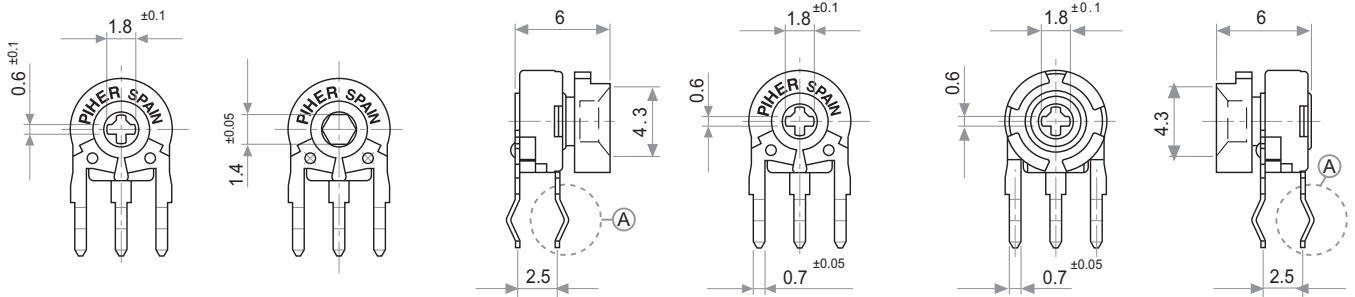

K = Cross slot thru hole

M = Hexagonal thru hole

X = Adjustable from collector side

W = Adjustable from terminal side

mounted knob / shaft

MOUNTING METHODS. VARIATIONS

v = Horizontal mount / Vertical adjust

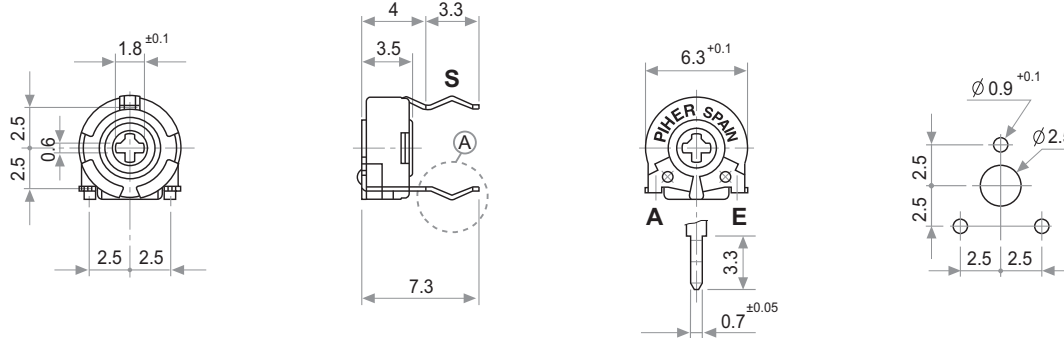

h = Vertical mount / Horizontal adjust

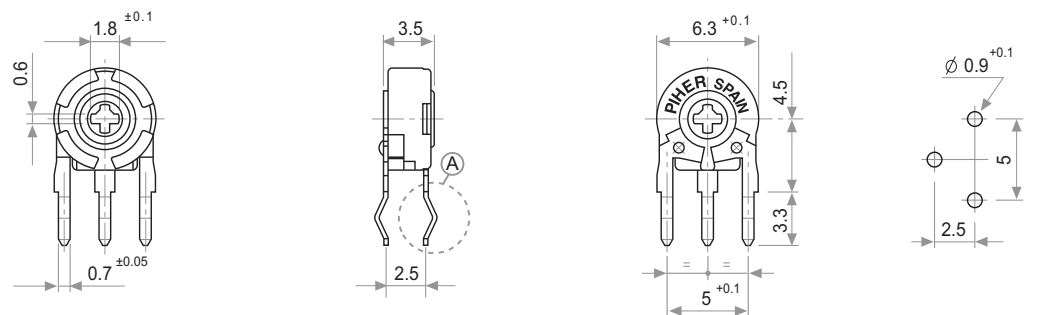

DETAIL A

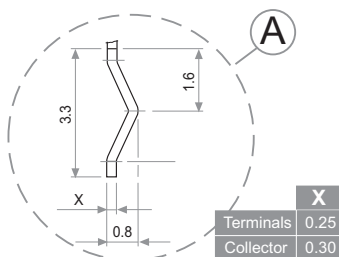

OPTIONS

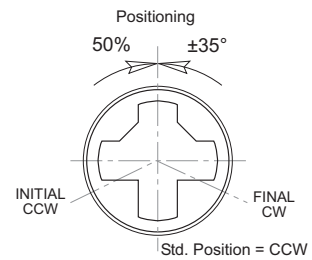
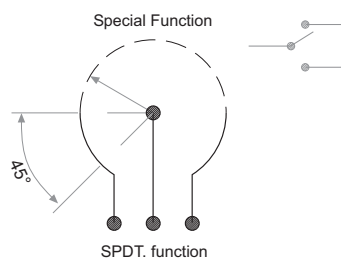

NOT-CRIMPED TERMINALS DIMENSIONS

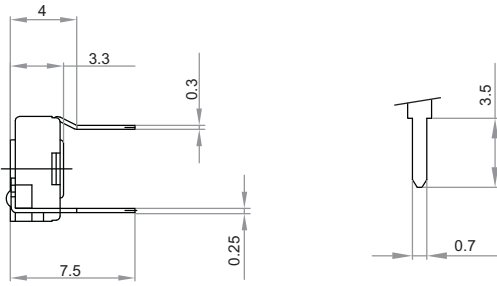

SMD VERSION

SMD / SMT version available:

See N-6 and PS-6 product datasheets at: www.pihher.net

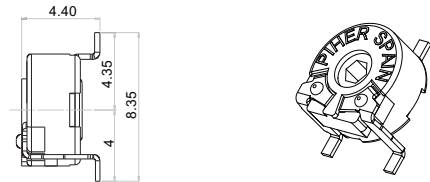

STANDARD DETENT CONFIGURATIONS

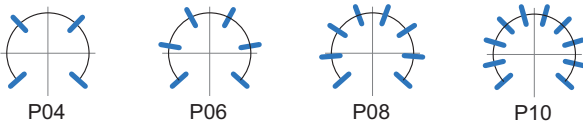

— Relative detent positions along the total mechanical travel.

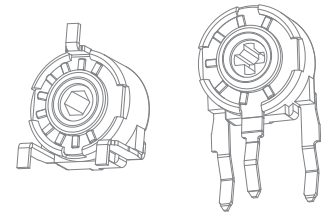

Unless otherwise specified the detents are evenly spaced (using the end points as reference).

For more than 10 detents versions please contact PIHER.

Mechanical and/or electrical features may be affected by detents.

Other detent configurations upon request

PACKAGING

BOXES

Model	Units
All	1.000

AUTOMATIC INSERTION

Magazines	Units per magazine
PT-6 V & PT-6 WV	80 Pieces

Magazines for PT-6 V with or without crimp.

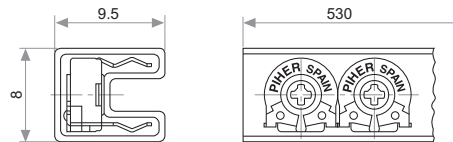

Magazines for PT-6 WV with or without crimp.

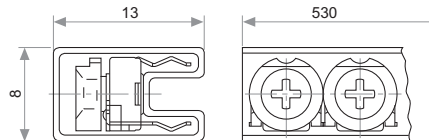

SHAFT / KNOB

If you wish to use your own custom plastic shaft/knob/actuator please contact Piher for advice about compatible materials.

Ref.: 5155 / Fig. 1

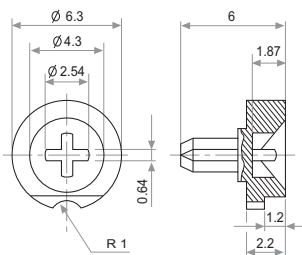

Shaft not suitable for magazine packaging

Ref.: 6132 / Fig. 2

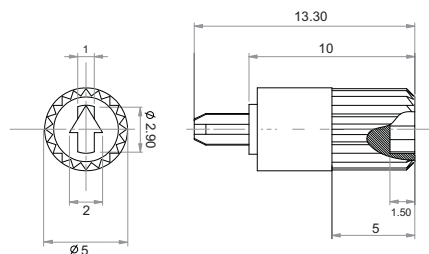

PT-6 DUAL GANG VERSION

For PT-6 dual gang version contact your nearest PIHER supplier

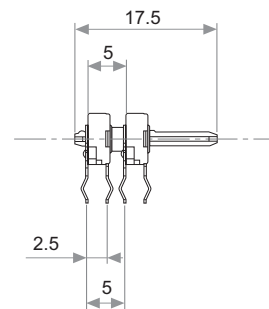

TESTS

ELECTRICAL LIFE	1.000 h. @ 50°C: 0.1 W	±5 %
MECHANICAL LIFE (CYCLES)	200 @ 10 CPM ...15 CPM	±3 % (Rn < 1 M.Ω)
TEMPERATURE COEFFICIENT	-25°C; +70°C	±300 ppm (Rn < 100 K)
THERMAL CYCLING	16 h. @ 85°C; 2h. @ -25°C	±2.5 %
DAMP HEAT	500 h. @ 40°C @ 95% HR	±5 %
VIBRATION (for each plane X,Y,Z)	2 h. @ 10 Hz. ... 55 Hz.	±2 %

NOTE: Out of range values may not comply with these results.

TYPICAL VARIATIONS

POWER RATING CURVE

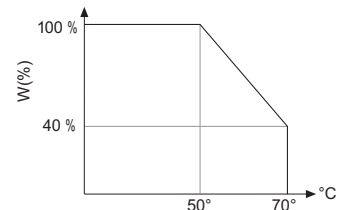

Disclaimer

The product information in this catalogue is for reference purposes. Please consult for the most up to date and accurate design information.

Piher Sensors & Controls S.A., its affiliates, agents, and employees, and all persons acting on its or their behalf (collectively, "Piher"), disclaim any and all liability for any errors, inaccuracies or incompleteness contained herein or in any other disclosure relating to any product described herein.

Piher disclaims any and all liability arising out of the use or application of any product described herein or of any information provided herein to the maximum extent permitted by law. The product specifications do not expand or otherwise modify Piher's terms and conditions of sale, including but not limited to the warranty expressed therein, which apply to these products.

No licence, express or implied, by estoppel or otherwise, to any intellectual property rights is granted by this document or by any conduct of Piher.

The products shown herein are not designed for use in medical, life-saving, or life-sustaining applications unless otherwise expressly indicated. Customers using or selling Piher products not expressly indicated for use in such applications do so entirely at their own risk and agree to fully indemnify Piher for any damages arising or resulting from such use or sale. Please contact authorised Piher personnel to obtain written terms and conditions regarding products designed for such applications.

Product names and markings noted herein may be trademarks of their respective owners.

Information contained in and/or attached to this catalogue may be subject to export control regulations of the European Community, USA, or other countries. Each recipient of this document is responsible to ensure that usage and/or transfer of any information contained in this document complies with all relevant export control regulations. If you are in any doubt about the export control restrictions that apply to this information, please contact the sender immediately. For any Piher International Corp. Exports, Note: All products / technologies are EAR99 Classified commodities. Exports from the United States are in accordance with the Export Administration Regulations. Diversion contrary to US law is prohibited.

