

### FEATURES

- Carbon resistive element.
- IP54 protection according to IEC 60529.
- Polyester substrate.
- SMD version available (see PS-6 datasheet).
- Also upon request:
  - Wiper positioned at 50% or fully clockwise
  - Supplied in magazines for automatic insertion
  - Long life model (10K cycles)
  - Housing available in self extinguishable plastic (UL94V0)
  - Mechanical detents

### MECHANICAL SPECIFICATIONS

- Mechanical Rotation angle:  $235^\circ \pm 5^\circ$
- Electrical Rotation angle:  $200^\circ \pm 20^\circ$
- Torque: 0.2 to 2 Ncm. (0.3 to 2.7 in-oz)
- Stop torque:  $> 4$  Ncm. ( $> 5.6$  in-oz)
- Life\*: Up to 10K cycles

### ELECTRICAL SPECIFICATIONS

- Range of values\*  
 $220\Omega \leq R_n \leq 5M$  (Decad. 1.0 - 2.0 - 2.2 - 2.5 - 4.7 - 5.0)
- Tolerance\*:  $220\Omega \leq R_n \leq 1M\Omega$  .....  $\pm 20\%$   
 $1M\Omega < R_n \leq 5M\Omega$  .....  $\pm 30\%$
- Max. Voltage: 100 VDC (lin), 50 VDC (no lin)
- Nominal Power 50°C (122°F) (see power rating curve)  
 $0.1$  W (lin)  $0.05$  W (no lin)
- Taper\*: Lin; Log; Alog (Log & Alog. only  $R_n \geq 1K$ )
- Residual resistance\*:  $\leq 0.5\%$   $R_n$  (5Ω min)
- Equivalent Noise Resistance:  $\leq 3\%$   $R_n$  (3Ω min)
- Operating Temperature\*\*:  $-25^\circ C + 70^\circ C$  ( $-13^\circ F + 158^\circ F$ )

\* Others check availability.

\*\* Up to 85°C depending on application.

### HOW TO ORDER

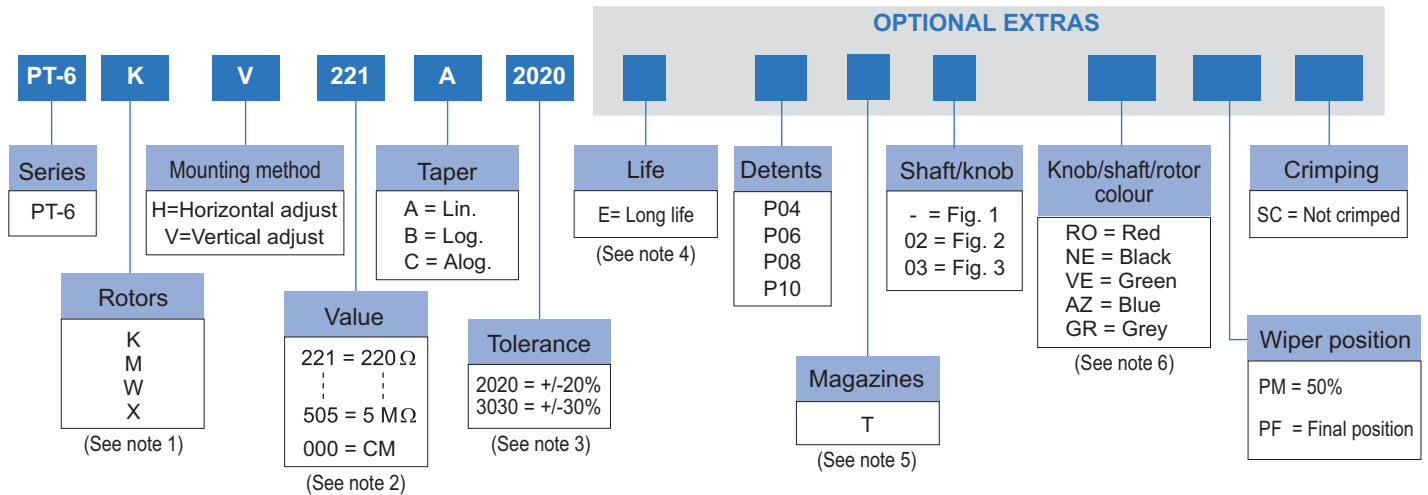

#### NOTES:

(1) Adjust. type: «X» is only available with horizontal adjusting method.

(2) Value: - Code:  $\frac{22}{1} = 220\Omega$   
 - 000 = CM = Switch version (contact us)  
 Number of zeros  
 First two digits.

(3) Tolerance (non standard): check availability..... Code eg.:  $\frac{+7}{-5} = \frac{07}{05}$   
 Negative tolerance  
 Positive tolerance

(4) Life: • Standard = 1000 cycles • Long = 10K cycles (non-detented models)

(5) Only for "V" mounting method. "W" rotor with shaft Fig. 2 is not available in magazines.

(6) Potentiometer without knob or shaft, only the rotor. Potentiometer with knob or shaft, only the knob/shaft. Default colour for knob/shaft is cream. Shaft only available in cream or black colour.

NOTE: The information contained here should be used for reference purposes only.



## NOT-CRIMPED TERMINALS DIMENSIONS

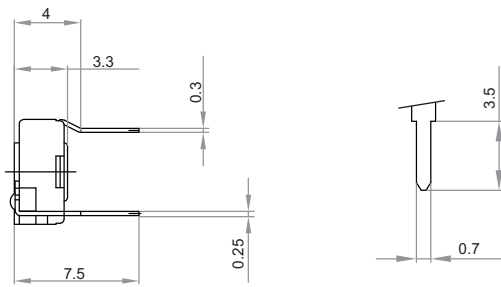

## SMD VERSION

SMD / SMT version available:

See N-6 and PS-6 product datasheets at: [www.pihher.net](http://www.pihher.net)

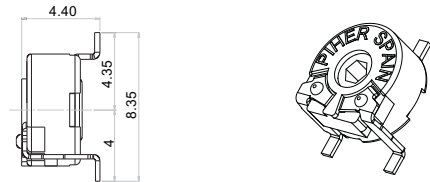

## STANDARD DETENT CONFIGURATIONS

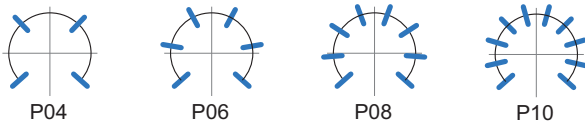

— Relative detent positions along the total mechanical travel.

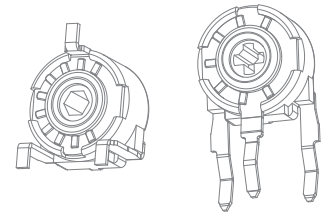

Examples of custom configurations.

### NOTES FOR DETENTED VERSIONS:

- (1) All detented versions will be studied case by case. Contact Piher for leadtimes and availability.
- (2) Others check availability. Unless otherwise specified the detents are evenly spaced (using the end points as reference).  
For more than 10 detents versions please contact your nearest PIHER authorised distributor.
- (3) Standard mechanical life: 100 cycles.
- (4) Long life versions are available under request and have the following characteristics at T<sup>a</sup>:  
- Potentiometers with 1 to 3 detents: up to 10K cycles.  
- Potentiometers with 4 and more detents: up to 5K cycles.
- (5) Detent torque can vary from 1.2 to 2.5 times the standard potentiometer torque.

## PACKAGING

### BOXES

#### Model

All

#### Units

1.000

### AUTOMATIC INSERTION

#### Magazines

PT-6 V & PT-6 WV

#### Units per magazine

80 Pieces

### Magazines for PT-6 V with or without crimp.

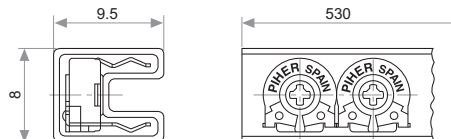

### Magazines for PT-6 WV with or without crimp.

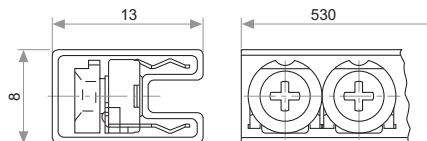

## PT-6 DUAL GANG VERSION

### Ref.: 6060

For PT-6 dual gang version contact your nearest PIHER supplier

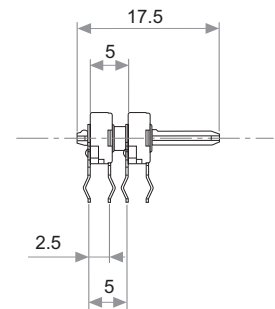

## SHAFT / KNOB

If you wish to use your own custom plastic shaft/knob/actuator please contact Piher for advice about compatible materials.

### Ref.: 5155 / Fig. 1

Default knob. Standard colour: white.

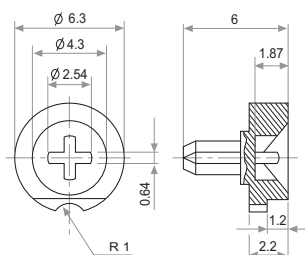

### Ref.: 5141 / Fig. 3

Colour: grey. For other colours check availability.

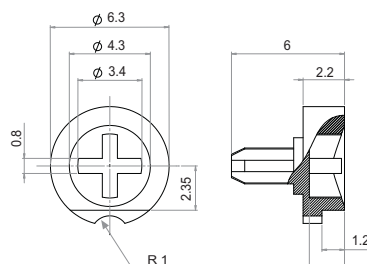

### Ref.: 6132 / Fig. 2

Shaft not suitable for magazine packaging

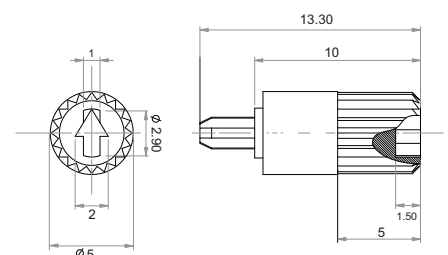

## TESTS

## TYPICAL VARIATIONS

## POWER RATING CURVE

ELECTRICAL LIFE	1.000 h. @ 50°C: 0.1 W	±5 %
MECHANICAL LIFE (CYCLES)	1000 @ 10 CPM ...15 CPM	±4 % (Rn < 1 MΩ)
TEMPERATURE COEFFICIENT	-25°C; +70°C	±300 ppm (Rn < 100 K)
THERMAL CYCLING	16 h. @ 85°C; 2h. @ -25°C	±2.5 %
DAMP HEAT	500 h. @ 40°C @ 95% HR	±5 %
VIBRATION (for each plane X,Y,Z)	2 h. @ 10 Hz. ... 55 Hz.	±2 %

NOTE: Out of range values may not comply with these results.

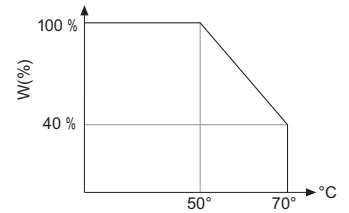

## RECOMMENDED CONNECTIONS

Piher potentiometer's recommended connection circuit for a position sensor or control application. (voltage divider circuit electronic design).

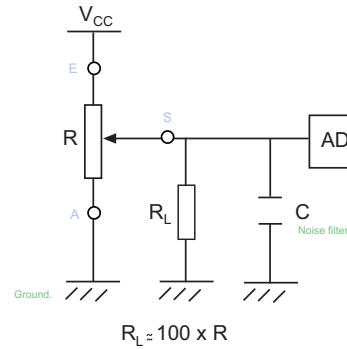

### Disclaimer

The product information in this catalogue is for reference purposes. Please consult for the most up to date and accurate design information.

Piher Sensors & Controls S.A., its affiliates, agents, and employees, and all persons acting on its or their behalf (collectively, "Piher"), disclaim any and all liability for any errors, inaccuracies or incompleteness contained herein or in any other disclosure relating to any product described herein.

Piher disclaims any and all liability arising out of the use or application of any product described herein or of any information provided herein to the maximum extent permitted by law. The product specifications do not expand or otherwise modify Piher's terms and conditions of sale, including but not limited to the warranty expressed therein, which apply to these products.

No licence, express or implied, by estoppel or otherwise, to any intellectual property rights is granted by this document or by any conduct of Piher.

The products shown herein are not designed for use in medical, life-saving, or life-sustaining applications unless otherwise expressly indicated. Customers using or selling Piher products not expressly indicated for use in such applications do so entirely at their own risk and agree to fully indemnify Piher for any damages arising or resulting from such use or sale. Please contact authorised Piher personnel to obtain written terms and conditions regarding products designed for such applications.

Product names and markings noted herein may be trademarks of their respective owners.

Information contained in and/or attached to this catalogue may be subject to export control regulations of the European Community, USA, or other countries. Each recipient of this document is responsible to ensure that usage and/or transfer of any information contained in this document complies with all relevant export control regulations. If you are in any doubt about the export control restrictions that apply to this information, please contact the sender immediately. For any Piher International Corp. Exports, Note: All products / technologies are EAR99 Classified commodities. Exports from the United States are in accordance with the Export Administration Regulations. Diversion contrary to US law is prohibited.



All Piher products can be adapted to meet customer's requirements. Please always use the latest updated datasheets published at our website [www.piher.net](http://www.piher.net)