

Features

Switching Regulator

- Efficiency up to 96%, no need for heatsinks
- 2A continuous output current
- Vin up to 32V
- Vout: 1.2V - 15V
- Wide operating temperature -40°C to +70°C at full load
- Continuous short circuit protection
- Pin compatible with TO220 linear regulators
- Positive to negative converter

RECOM DC/DC Converter

R-78B-2.0

2.0 Amp
SIP3
Single Output



Description

The R-78Bxx-2.0 series high efficiency switching regulators are ideally suited to replace 78xx linear regulators and are pin compatible. The efficiency of up to 96% means that very little energy is wasted as heat. Full power is available over a temperature range of -40°C up to 70°C without the need for heatsinks with their additional space and mounting costs. A high input voltage of up to 32VDC and output voltages from 1.2V up to 15V, low ripple and noise figures and a short circuit input current of typically only 50mA round off the specifications of this versatile converter series.

Selection Guide

Part Number	Input Voltage Range [VDC]	Output Voltage [VDC]	Output Current [mA]	Efficiency @ full load		Max. Capacitive Load ⁽¹⁾ [µF]
				@ min Vin [%]	@ max. Vin [%]	
R-78B1.2-2.0	4.75 - 32	1.2	2000	87	72	3300
R-78B1.5-2.0	4.75 - 32	1.5	2000	90	79	3300
R-78B1.8-2.0	4.75 - 32	1.8	2000	91	80	3300
R-78B2.5-2.0	4.75 - 32	2.5	2000	92	84	2300
R-78B3.3-2.0	4.75 - 32	3.3	2000	92	86	1800
R-78B5.0-2.0	6.5 - 32	5	2000	94	90	820
R-78B9.0-2.0	11 - 32	9	2000	95	93	620
R-78B12-2.0	15 - 32	12	2000	96	94	470
R-78B15-2.0	18 - 32	15	2000	96	95	470

Notes:

Note1: Max. cap load is tested by nominal input and full resistive load

Model Numbering

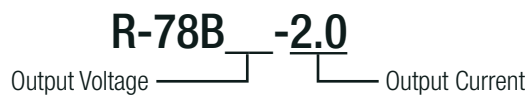

IEC62368-1 certified
EN62368-1 certified
EN55032 compliant
CB report

Specifications (measured @ Ta= 25°C, nom. Vin, full load and after warm up unless otherwise specified)

BASIC CHARACTERISTICS

Parameter	Condition		Min.	Typ.	Max.
Input Voltage Range	nom. Vin= 24VDC	1.2Vout - 3.3Vout	4.75VDC	24VDC	32VDC
		5Vout	6.5VDC		
		9Vout	11VDC		
		12Vout	15VDC		
		15Vout	18VDC		
Maximum Reverse Voltage					0V
Inrush Current				2A	
Quiescent Current	nom. Vin= 24VDC			2mA	
Internal Power Dissipation	Vout= 1.5VDC			0.35W	0.8W
Start-up time				10ms	
Rise Time				50µs	
Internal Operating Frequency	nom. Vin= 24VDC			460kHz	
Minimum Load			0%		
Output Ripple and Noise ⁽²⁾	20MHz BW	Vout ≤3.3VDC Vout ≥5VDC		50mVp-p 75mVp-p	

Notes:

Note2: Measurements are made with a 100nF MLCC across output (low ESR)

Efficiency vs. Load

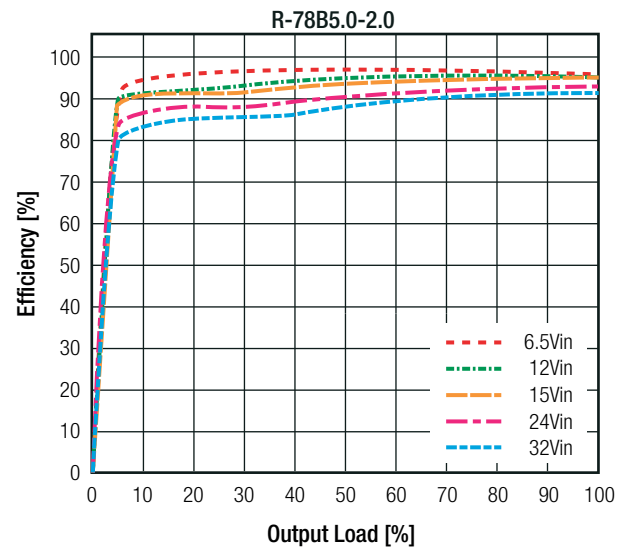
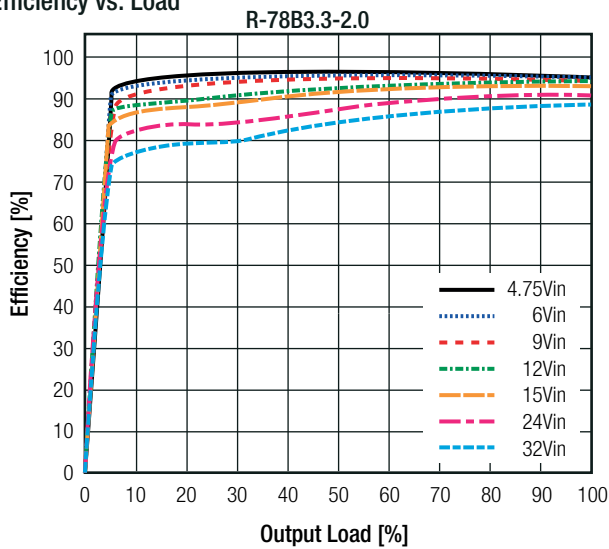

Efficiency vs. Input Voltage

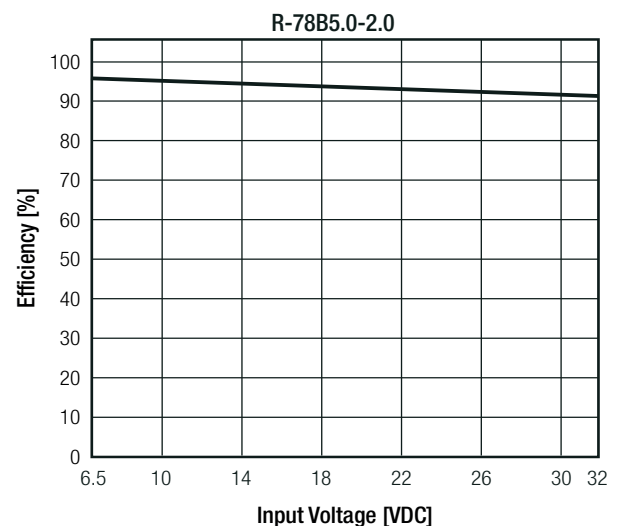
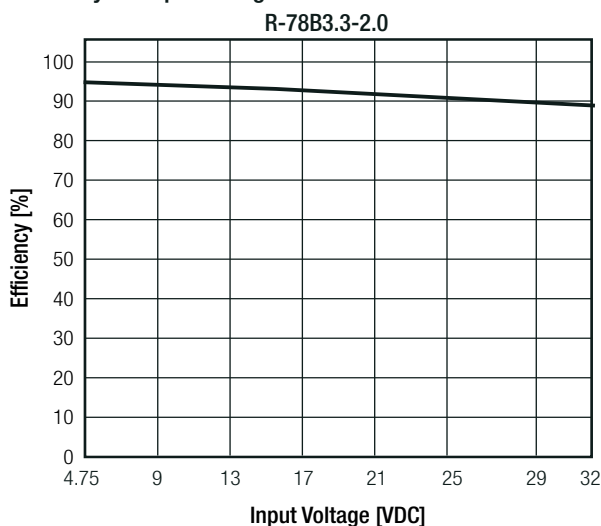

Specifications (measured @ Ta= 25°C, nom. Vin, full load and after warm up unless otherwise specified)

REGULATIONS		
Parameter	Condition	Value
Output Accuracy	100% load	±2.0% typ.
Line Regulation	low line to high line, full load	±0.5% typ.
Load Regulation	0% to 100% load	±1.0% typ.

PROTECTIONS		
Parameter	Condition	Value
Short Circuit Protection (SCP)	below 100mΩ	continuous, automatic recovery
Short Circuit Input Current	nom. Vin= 24VDC	<5Vout ≥5Vout
		50mA typ. 75mA typ.

ENVIRONMENTAL		
Parameter	Condition	Value
Operating Temperature Range	without derating (see graph)	-40°C to +70°C
Maximum Case Temperature		+105°C
Temperature Coefficient		0.02%/°C typ.
Operating Altitude		5000m
Operating Humidity	non-condensing	95% RH max.
Pollution Degree		PD2
Vibration		10-55Hz, 2G, 30min along X, Y and Z axis
MTBF	according to MIL-HDBK-217F, G.B.	+25°C 6349 x 10 ³ hours

Derating Graph

(@ Chamber and natural convection 0.1 m/s)

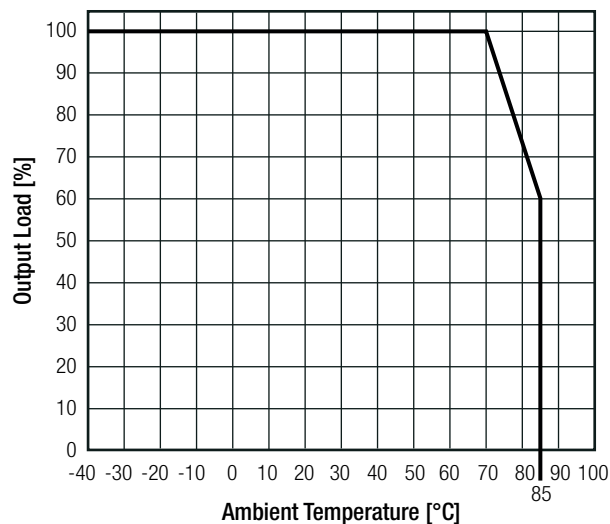

Specifications (measured @ Ta= 25°C, nom. Vin, full load and after warm up unless otherwise specified)

SAFETY AND CERTIFICATIONS

Certificate Type (Safety)	Report / File Number	Standard
Audio/video, information and communication technology equipment Safety requirements (CB Scheme)	L0339m38-B1-L	IEC62368-1: 2014, 2nd Edition EN62368-1: 2014
EAC	RU-AT.49.09571	TP TC 004/2011
RoHS2+		RoHS 2011/65/EU + AM2015/863

EMC Compliance	Condition	Standard / Criterion
Electromagnetic compatibility of multimedia equipment - Emission requirements	with external components (see filter suggestion below)	EN55032, Class A EN55032, Class B
Information technology equipment - Immunity characteristics - Limits and methods of measurement		EN55024:2010
Electromagnetic compatibility of multimedia equipment - Emission requirements		EN55032: 2013, Class B
ESD Electrostatic discharge immunity test	Air ±8kV; Contact ± 4kV	IEC61000-4-2, Criteria A
Radiated, radio-frequency, electromagnetic field immunity test	3 V/m	IEC61000-4-3, Criteria A
Fast Transient and Burst Immunity	±0.5kV	IEC61000-4-4, Criteria A
Surge Immunity	±0.5kV	IEC61000-4-5, Criteria A
Immunity to conducted disturbances, induced by radio-frequency fields	3V	IEC61000-4-6, Criteria A
Power Magnetic Field Immunity	50Hz/ 1A/m	IEC61000-4-8, Criteria A

EMC Filtering Suggestion according to EN55032

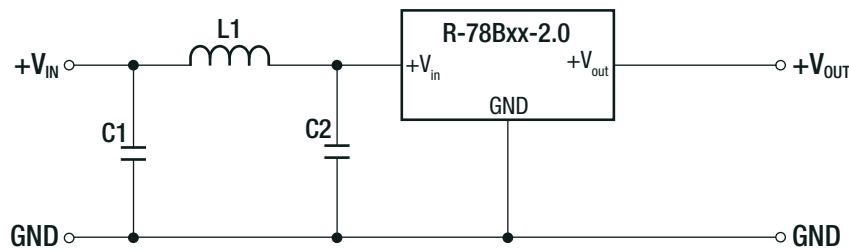

EN55022	C1	C2	L1
Class A	4.7µF 50V MLCC 1206	N/A	3.3µH Choke
Class B	10µF 50V MLCC 1210	4.7µF 50V MLCC 1206	10µH Choke

DIMENSION and PHYSICAL CHARACTERISTICS

Parameter	Type	Value
Material	case potting PCB	plastic, (UL94 V-0) silicone, (UL94 V-0) FR4, (UL94 V-0)
Dimension (LxWxH)		11.5 x 8.5 x 17.5mm
Weight		4.0g typ.

continued on next page

Specifications (measured @ Ta= 25°C, nom. Vin, full load and after warm up unless otherwise specified)

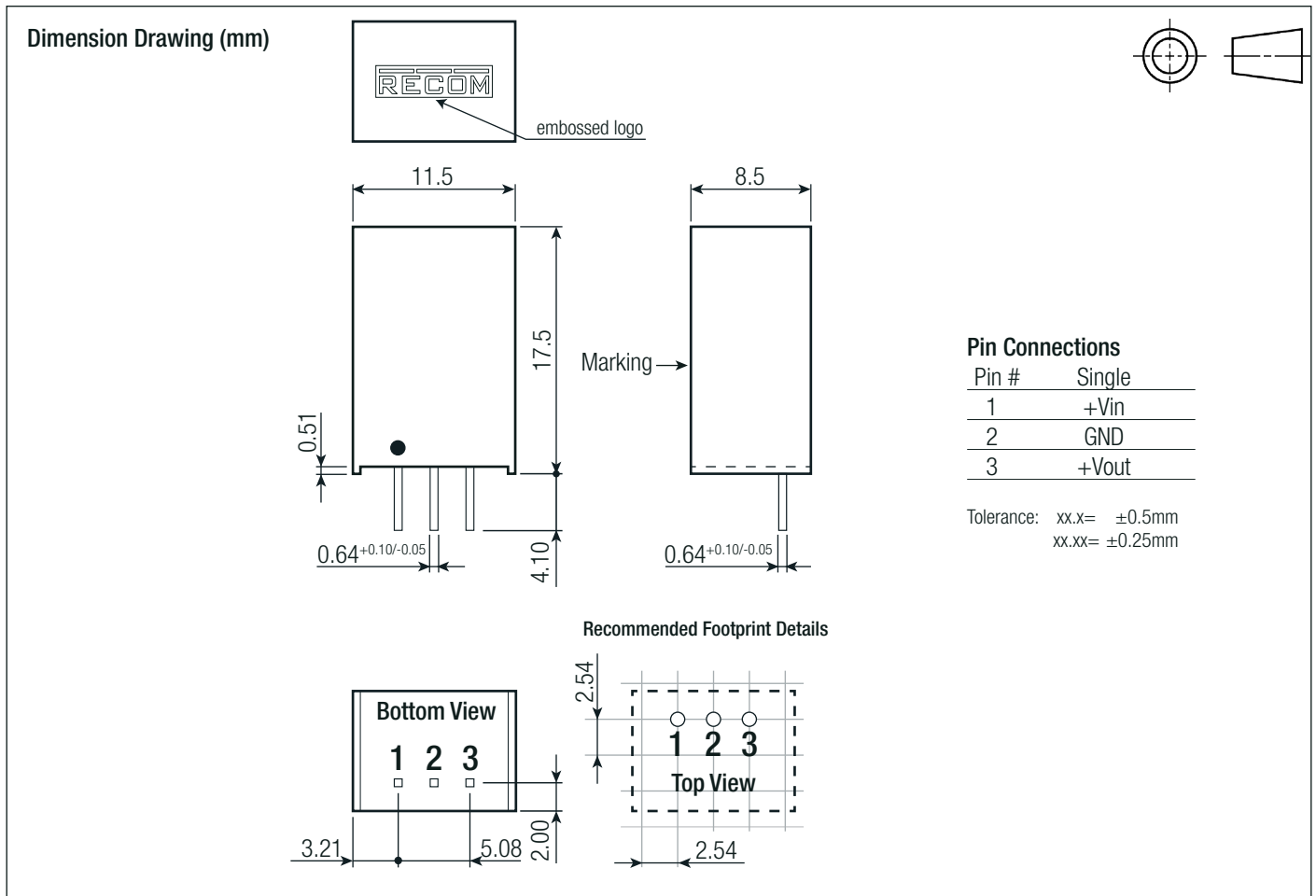

INSTALLATION and APPLICATION

Positive to Negative

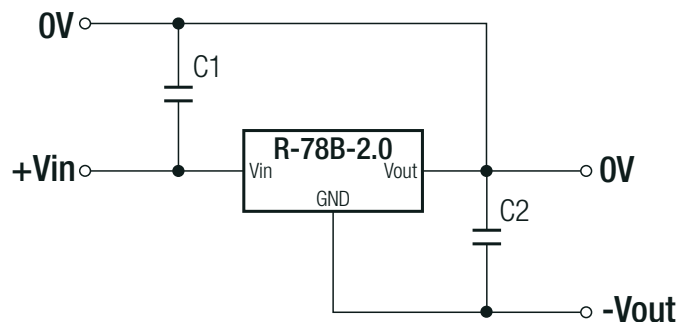

Part Number	Input Voltage Range [VDC]	Output Voltage [VDC]	Output Current [mA]	Efficiency @ full load @ min Vin [%]	Efficiency @ full load @ max. Vin [%]	External Capacitor [C1 / C2]
R-78B1.2-2.0	4.75 - 32	-1.2	-1000	86	86	10µF / 10µF
R-78B1.5-2.0	4.75 - 32	-1.5	-1000	74	87	10µF / 10µF
R-78B1.8-2.0	4.75 - 32	-1.8	-1000	76	88	10µF / 10µF
R-78B2.5-2.0	4.75 - 32	-2.5	-1000	79	89	10µF / 10µF
R-78B3.3-2.0	4.75 - 32	-3.3	-1000	83	89	10µF / 10µF
R-78B5.0-2.0	6.5 - 32	-5	-1000	86	90	10µF / 10µF
R-78B9.0-2.0	11 - 32	-9	-1000	90	91	10µF / 10µF
R-78B12-2.0	15 - 32	-12	-1000	91	92	10µF / 10µF
R-78B15-2.0	18 - 32	-15	-1000	92	93	10µF / 10µF

Specifications (measured @ Ta= 25°C, nom. Vin, full load and after warm up unless otherwise specified)

PACKAGING INFORMATION		
Parameter	Type	Value
Packaging Dimension (LxWxH)	tube	520.0 x 25.1 x 10.6mm
Packaging Quantity		42pcs
Storage Temperature Range		-55°C to +125°C
Storage Humidity	non-condensing	95% RH max.

The product information and specifications may be subject to changes even without prior written notice. The product has been designed for various applications; its suitability lies in the responsibility of each customer. The products are not authorized for use in safety-critical applications without RECOM's explicit written consent. A safety-critical application is an application where a failure may reasonably be expected to endanger or cause loss of life, inflict bodily harm or damage property. The applicant shall indemnify and hold harmless RECOM, its affiliated companies and its representatives against any damage claims in connection with the unauthorized use of RECOM products in such safety-critical applications.