

# Features

# Unregulated Converters

- 1W Power in SMD package
- Pin compatible with R1S/R1D series
- -40°C To +100°C Operating temperature @ full load
- High 3kVDC/1 second or 1kVDC/1 second isolation
- IEC/EN/UL62368-1 certified, CB Report
- 5000m operation

## Description

Low cost, low profile, open-frame 1W SMD isolated DC/DC converters available with single (R1SX) or dual (R1DX) outputs. The R1SX is available with 3.3V or 5V inputs and offers a single unregulated 3.3V or 5V output. The R1DX operates from 5V and offers  $\pm 5$ ,  $\pm 9$ ,  $\pm 12$  or  $\pm 15$  dual outputs. There is no minimum load requirement and the quiescent consumption is less than 150mW. Standard isolation is 1kVDC/1s and a /H version with 3kVDC/1s is available. The operating temperature is from -40°C up to +100°C without derating. The pin-out is industry standard and compatible with the R1S/R1D series, but at half the height. The converters are fully certified to IEC/EN/UL62368 and IEC/EN/UL60950 and are 10/10 RoHS-conform. Class A EMC conformity requires only an input capacitor and a simple low cost LC filter is all that is needed for Class B EMC. Standard packaging is tape and reel.

## Selection Guide

Part Number	nom. Input Voltage [VDC]	Output Voltage [VDC]	Output Current [mA]	Efficiency typ. <sup>(1)</sup> [%]	max. Capacitive Load <sup>(2)</sup> [ $\mu$ F]
R1SX-3.33.3	3.3	3.3	303	74	2200
R1SX-3.305	3.3	5	200	78	2200
R1SX-0505	5	5	200	78	2200
R1DX-0505	5	$\pm 5$	$\pm 100$	78	$\pm 1000$
R1DX-0509	5	$\pm 9$	$\pm 56$	78	$\pm 470$
R1DX-0512	5	$\pm 12$	$\pm 42$	80	$\pm 220$
R1DX-0515	5	$\pm 15$	$\pm 33$	80	$\pm 220$

### Notes:

Note1: Efficiency is tested at nominal input and full load at +25°C ambient

Note2: Max Cap Load is tested at nominal input and full resistive load

## Model Numbering

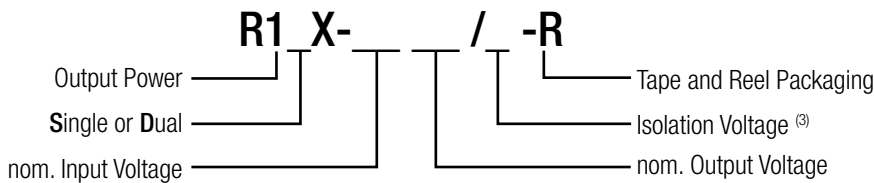

### Notes:

Note3: without suffix, standard isolation voltage (1kVDC/1 second)  
with suffix „/H“, high isolation voltage (3kVDC/1 second)

### Ordering Examples:

R1SX-3.305-R	3.3Vin	5Vout	Single Output	1kVDC/1 second isolation	tape and reel packaging
R1DX-0505-R	5Vin	$\pm 5$ Vout	Dual Output	1kVDC/1 second isolation	tape and reel packaging
R1SX-0505/H-R	5Vin	5Vout	Single Output	3kVDC/1 second isolation	tape and reel packaging
R1DX-0515/H-R	5Vin	$\pm 15$ Vout	Dual Output	3kVDC/1 second isolation	tape and reel packaging

**RECOM**  
DC/DC Converter

## R1SX/R1DX

1 Watt  
SMD  
Single & Dual  
Output

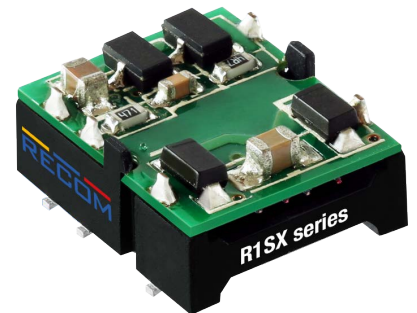

**UL**  
E224736

IEC/EN62368-1 certified  
UL62368-1 certified  
IEC/EN60950-1 certified  
C22.2 No. 62368-1-14 certified  
CB Report  
EN55032 compliant  
EN55024 compliant

Specifications (measured @ Ta= 25°C, nominal input voltage, full load unless otherwise specified)

### BASIC CHARACTERISTICS

Parameter	Condition	Min.	Typ.	Max.
Internal Input Filter				capacitor
Input Voltage Range			±10.0%	
Quiescent Current				40mA
Minimum Load		0%		
Internal Operating Frequency		20kHz	60kHz	100kHz
Output Ripple and Noise <sup>(4)</sup>	20MHz BW			100mVp-p

**Notes:**

Note4: Measurements are made with a 0.1µF MLCC across output. (low ESR)

### Efficiency vs. Load

R1SX-3.33.3(/H)

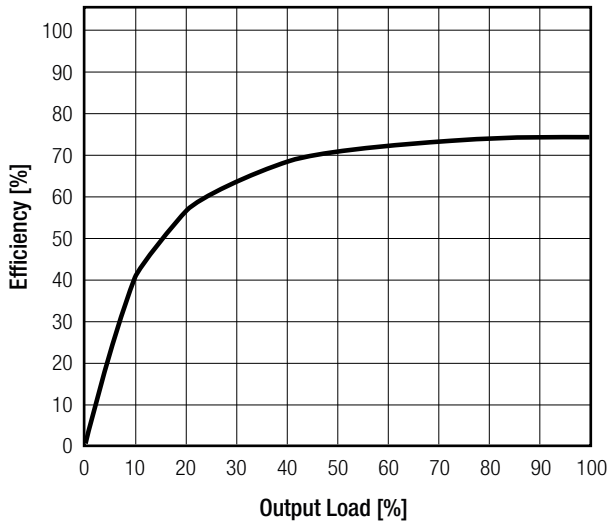

R1SX-xx05(/H)

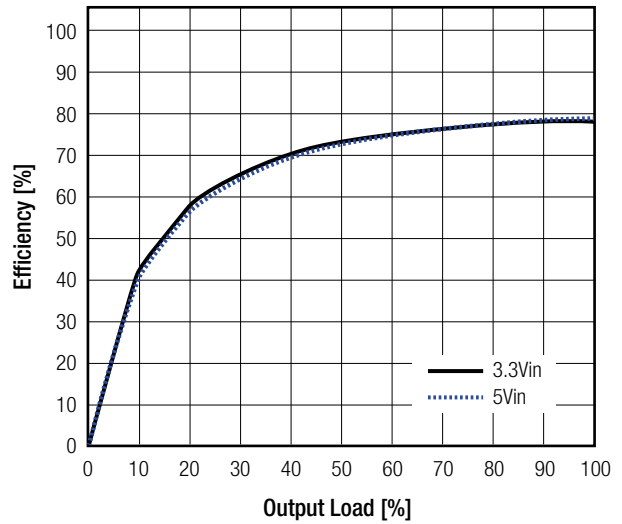

R1DX-05xx(/H)

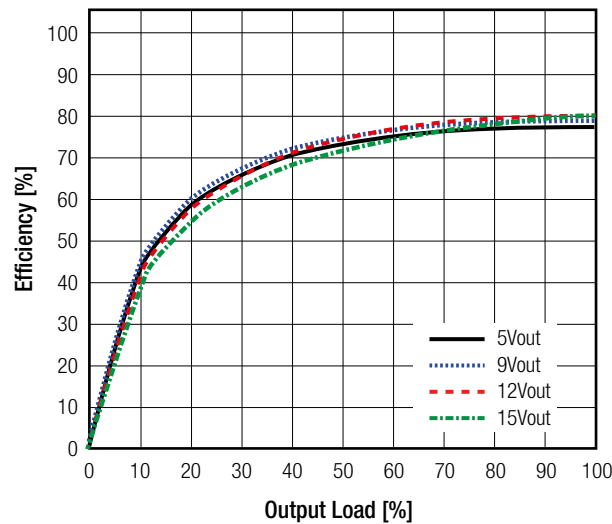

Specifications (measured @ Ta= 25°C, nominal input voltage, full load unless otherwise specified)

**REGULATIONS**

Parameter	Condition		Value
Output Accuracy			±5.0% max.
Line Regulation	low line to high line		±1.2% typ. at ±1.0% of Vin typ.
Load Regulation	10% to 100% load	single output	3.3VDC 5VDC 10.0% typ. / 15.0% max. 7.0% typ. / 15.0% max.
		dual output	3.3VDC, 5VDC 9VDC, 12VDC, 15VDC 10.0% typ. / 15.0% max. 8.0% typ. / 10.0% max.
Cross Regulation	dual output only		±6.5% max.

**Tolerance Envelope**

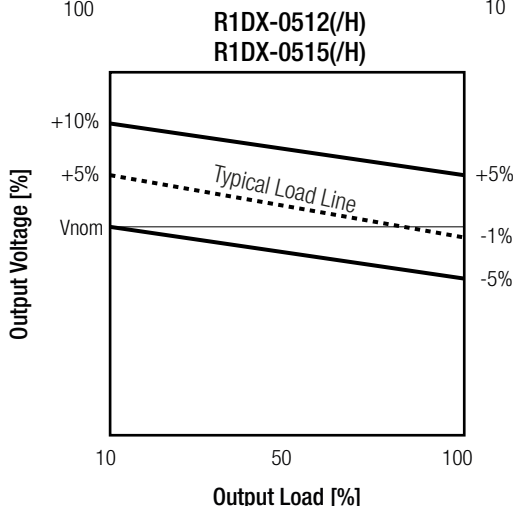
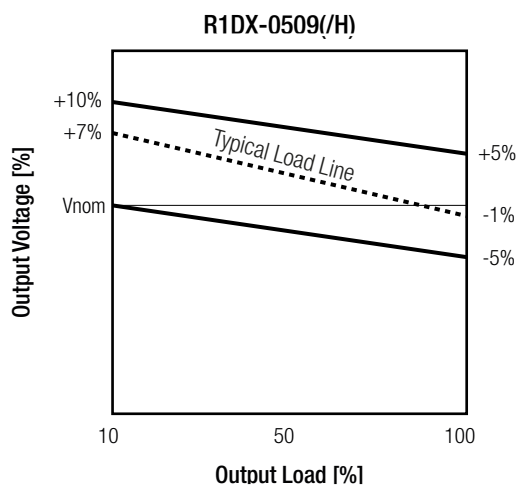
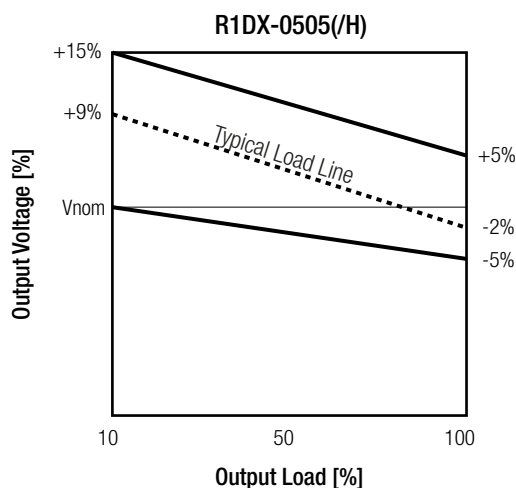
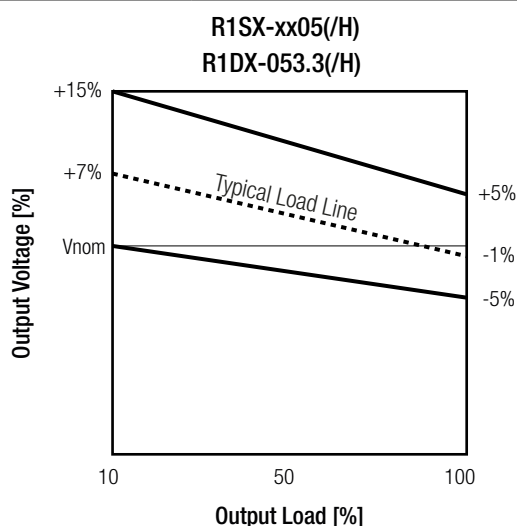
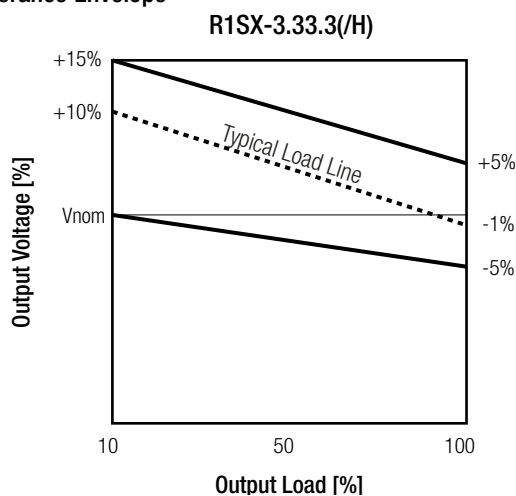

**Specifications** (measured @ Ta= 25°C, nominal input voltage, full load unless otherwise specified)

PROTECTIONS			
Parameter	Type		Value
Isolation Voltage	I/P to O/P	standard	tested for 1 second rated for 1 minute <sup>(5)</sup> 1kVDC 500VAC
	I/P to O/P	with suffix "/H"	tested for 1 second rated for 1 minute <sup>(5)</sup> 3kVDC 1.5kVAC
Isolation Resistance			10GΩ min.
Isolation Capacitance	single		70pF max.
	dual		100pF max.
Leakage Current	standard		1μA max.
	with suffix "/H"		3μA max.
Insulation Grade			functional

### Protection Circuit

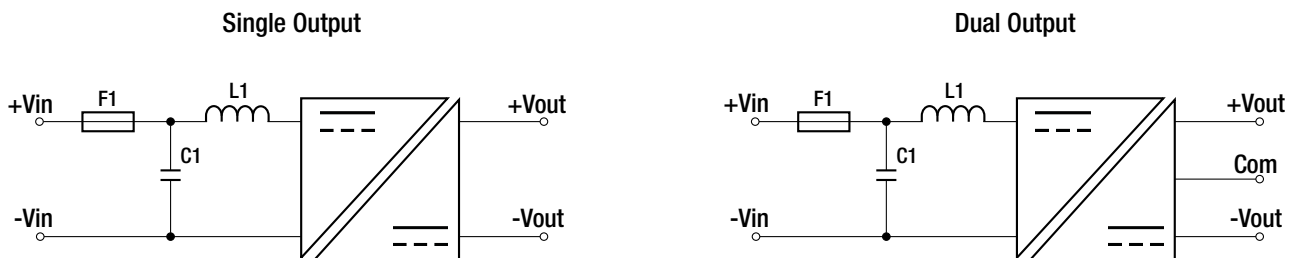

### Notes:

Note5: For repeat Hi-Pot testing, reduce the time and/or the test voltage

Note6: Refer to local wiring regulations if input over-current protection is also required. Recommended fuse: T1A slow blow type

ENVIRONMENTAL				
Parameter	Condition		Value	
Operating Temperature Range	full load (refer to derating graph)	single	-40°C to +100°C	
		dual	-40°C to +95°C	
Operating Altitude			5000m	
Operating Humidity	non-condensing		5% - 95% RH max.	
Pollution Degree			PD2	
Vibration			according to MIL-STD-202G	
MTBF	according to MIL-HDBK-217F, G.B.	single	+25°C	21400 x 10 <sup>3</sup> hours
			+100°C	7800 x 10 <sup>3</sup> hours
		dual	+25°C	20900 x 10 <sup>3</sup> hours
			+95°C	7200 x 10 <sup>3</sup> hours

continued on next page

**Specifications** (measured @ Ta= 25°C, nominal input voltage, full load unless otherwise specified)

**Derating Graph**

(@ Chamber and natural convection 0.1m/s)

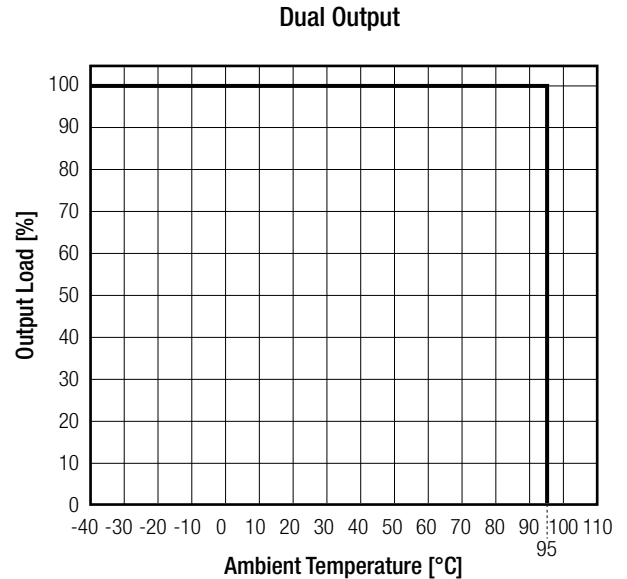
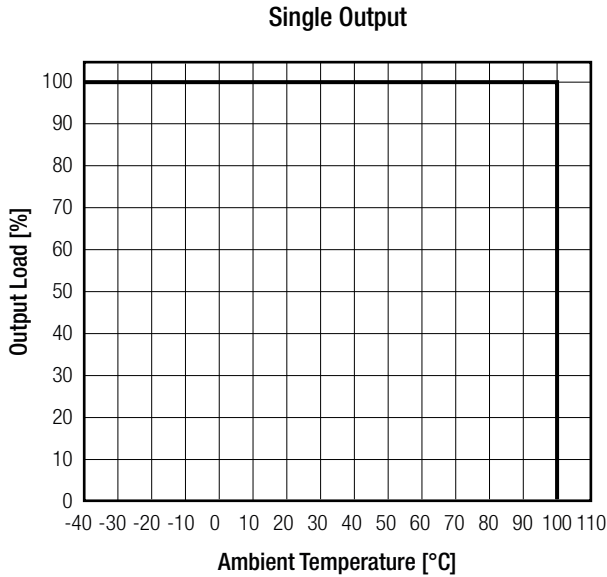

**SAFETY AND CERTIFICATIONS**

Certificate Type (Safety)	Report / File Number	Standard
Information Technology Equipment, General Requirements for Safety	E224736	UL60950-1, 2nd Edition 2014 CAN/CSA C22.2 No. 60950-1-07, 2nd Edition 2014
Information Technology Equipment, General Requirements for Safety (CB)	E224736-4788277362-2	IEC60950-1:2005 2nd Edition + A2:2013
Information Technology Equipment, General Requirements for Safety		EN60950-1:2006 + A2:2013
Audio/video, information and communication technology equipment - Safety requirements (LVD)	E224736	UL62368, 2nd Edition, 2014 CAN/CSA -C22.2 No. 62368-1-14, 2nd Edition, 2014
Audio/video, information and communication technology equipment - Safety requirements	E224736-4788277362-1	EN62368-1:2014 + A11:2017
Audio/video, information and communication technology equipment - Safety requirements (CB)		IEC62368-1:2014 2nd Edition
RoHS2+		RoHS 2011/65/EU + AM2015/863

EMC Compliance	Condition	Standard / Criterion
Information technology equipment - Radio disturbance characteristics - Limits and methods of measurement	with external filter (see filter suggestion)	EN55032:2015, Class B
Information technology equipment - Immunity characteristics Limits and methods of measurement		EN55024:2010 +A1:2015
ESD Electrostatic discharge immunity test	R1DX Air: ±8, 6, 4, 2kV Contact: ±4, 2kV	IEC61000-4-2:2008, Criteria A
	R1SX Air: ±8, 6, 4, 2kV Contact: ±4, 2kV	IEC61000-4-2:2008, Criteria B
Radiated, radio-frequency, electromagnetic field immunity test	3 V/m	IEC61000-4-3:2006 + A2:2010, Criteria A
Fast Transient and Burst Immunity	±0.5kV	IEC61000-4-4:2012, Criteria A
Surge Immunity	R1DX only	IEC61000-4-5:2014, Criteria B
	R1SX ±0.5kV	IEC61000-4-5:2014, Criteria A
Immunity to conducted disturbances, induced by radio-frequency fields	3V r.m.s.	IEC61000-4-6:2013, Criteria A
Power Magnetic Field Immunity	50Hz / 1A/m	IEC61000-4-8:2009, Criteria A

continued on next page

Specifications (measured @ Ta= 25°C, nominal input voltage, full load unless otherwise specified)

### EMC Filtering Suggestions for EN55032

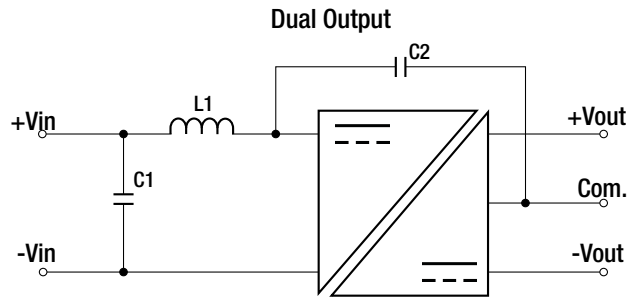
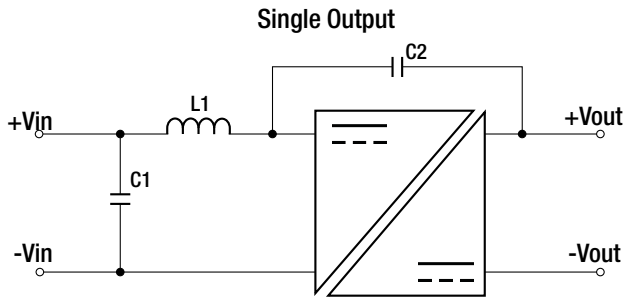

Component Liss Class A			
Model	C1	C2	L1
R1SX-3.3xxS	22µF MLCC	470pF/4kVDC	N/A
R1SX-05xxS			
R1DX-05xxD	10µF MLCC		10µH SMD Inductor

Component Liss Class B			
Model	C1	C2	L1
R1SX-3.3xxS	22µF MLCC	470pF/4kVDC	3.3µH SMD Inductor
R1SX-05xxS	10µF MLCC		4.7µH SMD Inductor
R1DX-05xxD			10µH SMD Inductor

### DIMENSION and PHYSICAL CHARACTERISTICS

Parameter	Type	Value
Material	Case	black plastic (UL94V-0)
	PCB	FR4 (UL94V-0)
Package Dimension (LxWxH)	single	12.75 x 11.10 x 5.80mm
	dual	15.24 x 11.10 x 8.00mm
Package Weight	single	1.0g typ.
	dual	1.2g typ.

### Dimension Drawing R1SX (mm)

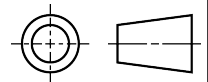
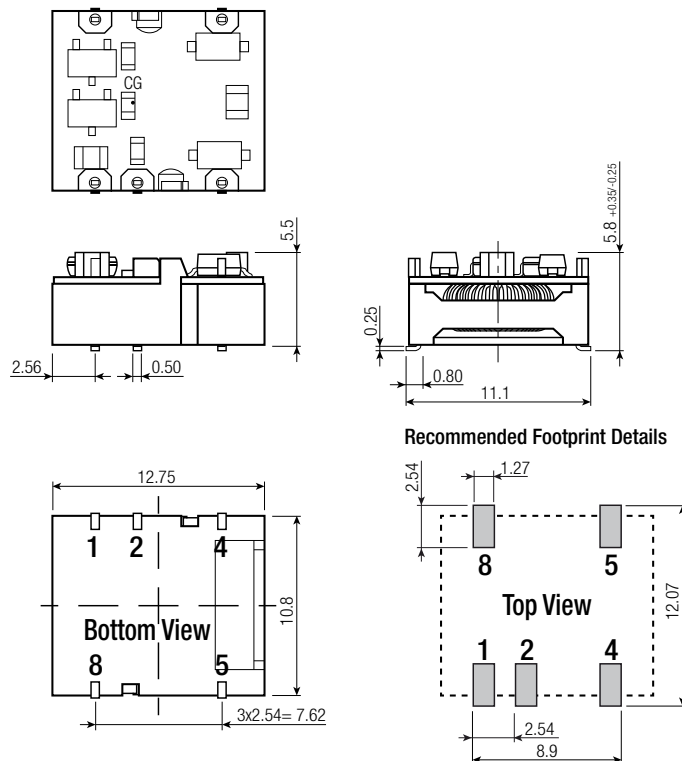

### Pin Connection

Pin #	Single
1	-Vin
2	+Vin
4	-Vout
5	+Vout
8	NC

CG= center of gravity

NC= no connection

Tolerance: xx.x= ±0.5mm

xx.xx= ±0.25mm

Pin

Thickness: ±0.05mm

Length: +0.25/-0.50mm

continued on next page

Specifications (measured @ Ta= 25°C, nominal input voltage, full load unless otherwise specified)

Dimension Drawing R1DX (mm)

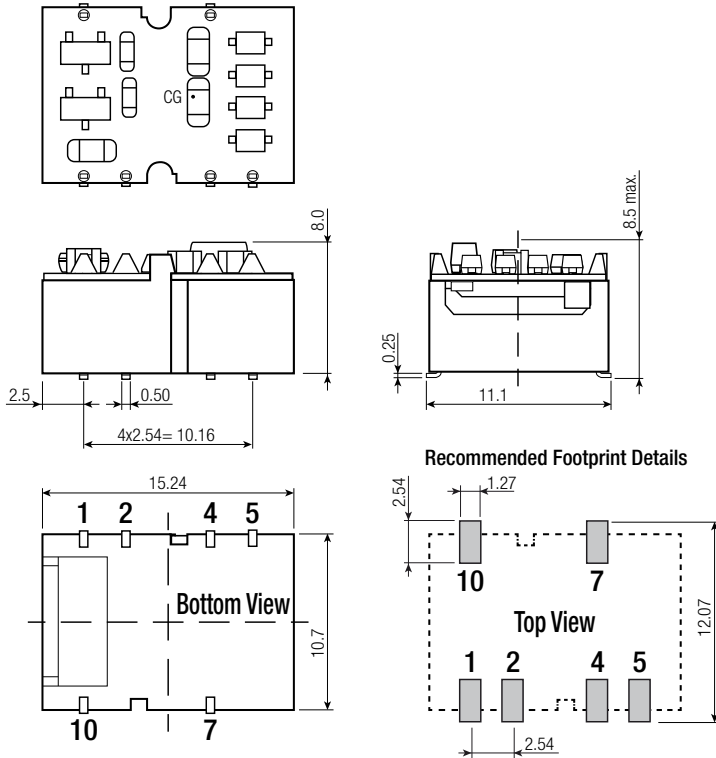

Pin Connection

Pin #	Dual
1	-Vin
2	+Vin
4	Com.
5	-Vout
7	+Vout
10	NC

CG= center of gravity  
NC= no connection  
Tolerance: xx.x= ±0.5mm  
          xx.xx= ±0.25mm

Pin Thickness: ±0.05mm  
Length: +0.25/-0.50mm

INSTALLATION and APPLICATION

Isolated Bus

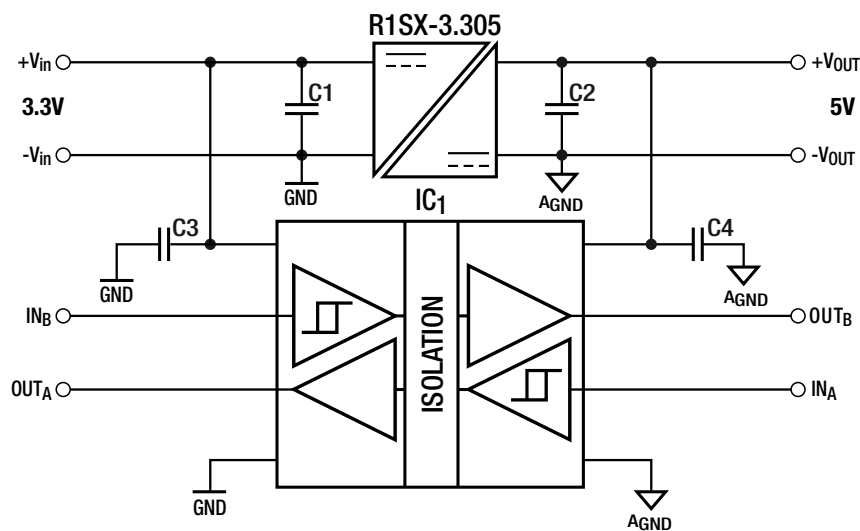

Block diagram of an isolated data interface with 3.3V to 5V logic level shifting. Typical Applications include microcontroller interfacing, logic level translation and multi-channel test and measurement systems.

continued on next page

Specifications (measured @ Ta= 25°C, nominal input voltage, full load unless otherwise specified)

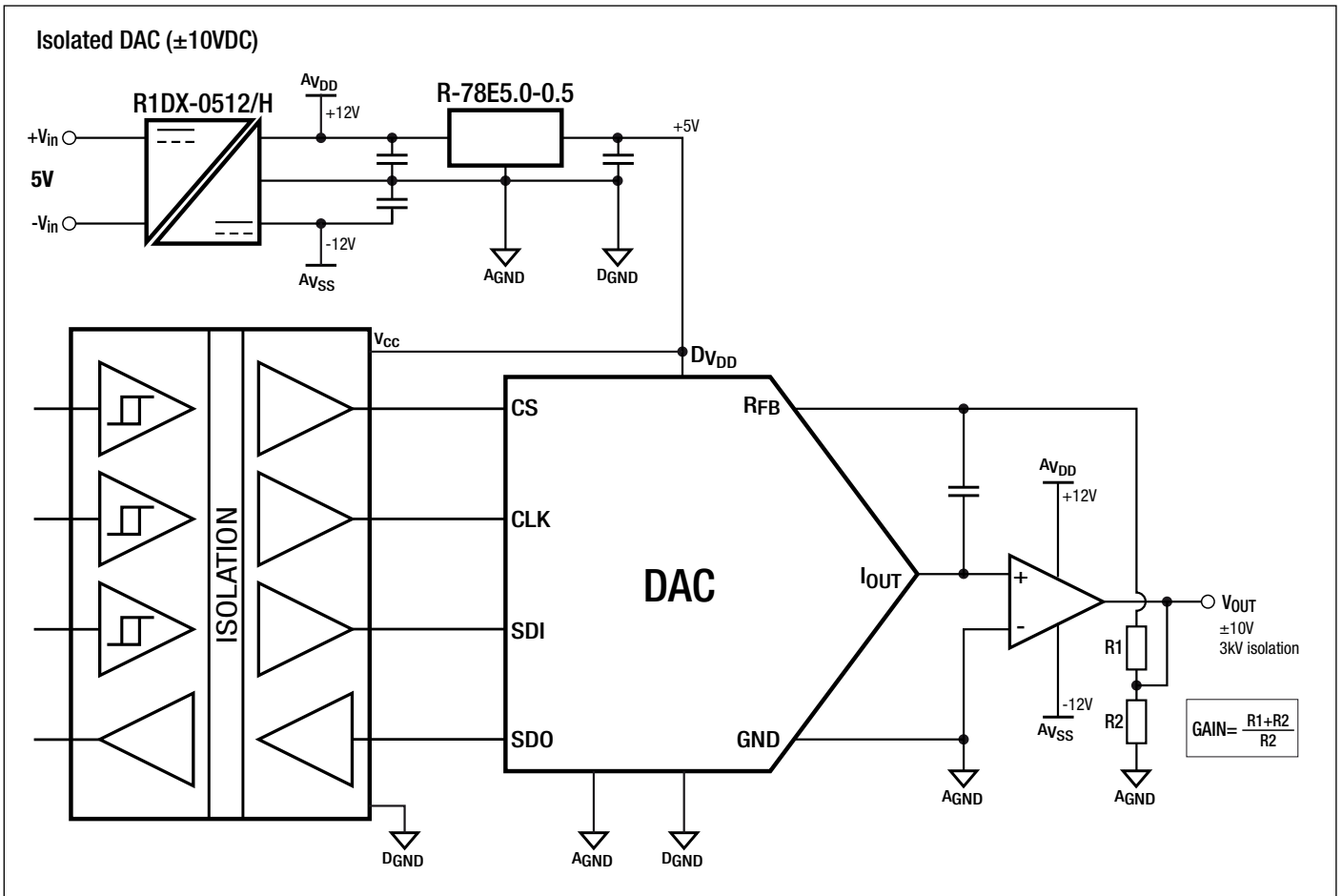

### PACKAGING INFORMATION

Packaging Dimension (LxWxH)	tape and reel (carton)	355.0 x 340.0 x 35.0mm
	reel	330.2 x 330.2 x 30.0mm
Packaging Quantity	single	450pcs
	dual	250pcs
Tape Width		24.0mm
Storage Temperature Range		-55°C to +125°C
Storage Humidity		5% - 95% RH max.

The product information and specifications may be subject to changes even without prior written notice. The product has been designed for various applications; its suitability lies in the responsibility of each customer. The products are not authorized for use in safety-critical applications without RECOM's explicit written consent. A safety-critical application is an application where a failure may reasonably be expected to endanger or cause loss of life, inflict bodily harm or damage property. The applicant shall indemnify and hold harmless RECOM, its affiliated companies and its representatives against any damage claims in connection with the unauthorized use of RECOM products in such safety-critical applications.