

## Data Sheet

Customer: \_\_\_\_\_

Product: Current Sensing Thick Film Chip Resistor-RS Series

Size: 0402/0603/0805/1206/1210/2010/2512

Issued Date: 15-Sep-09

Edition: REV.A4



**VIKING TECH CORPORATION**

光頡科技股份有限公司  
No.70, Kuanfu N. Rad.,  
Hsin Chu Industrial Park,  
Hukou Hsiang, Hsin Chu Hsien,  
303, Taiwan

TEL:886-3-5972931

FAX:886-3-5972935•886-3-5973494

E-mail:sales@viking.com.tw

**VIKING TECH CORPORATION KAOHSIUNG BRANCH**

光頡科技股份有限公司高雄分公司  
No.248-3, Sin-Sheng Rd., Cian-Jhen Dist., Kaohsiung,  
806, Taiwan

TEL:886-7-8217999

FAX:886-7-8228229

E-mail:sales@viking.com.tw

**WUXI TMTEC CO., LTD.**

無錫泰銘電子有限公司  
No.1A,(Xixia Road),Machinery & Industry Park,  
National Hi-Tech Industrial Development Zone of  
Wuxi, Wuxi, Jiangsu Province, China

Zip Code:214028

TEL:86-510-85203339

FAX:86-510-85203667•86-510-85203977

E-mail:wuxisales@tmtec.com.tw

Produced by (QC)	Checked (QC)	Approved by (QC)	Prepared by (Sales)	Accepted by (Customer)
15-Sep-09	15-Sep-09	15-Sep-09	15-Sep-09	
<b>Shella Huang</b>	<b>J.C. Liu</b>	<b>J.C. Liu</b>		

## Current Sensing Thick Film Chip Resistor – RS Series

### Scope

– This specification applies to all sizes of rectangular-type fixed chip resistors with Ruthenium-base as material.

### Features

- Low inductance
- Highly reliable multilayer electrode construction
- Higher component and equipment reliability
- Reduced size of final equipment reliability

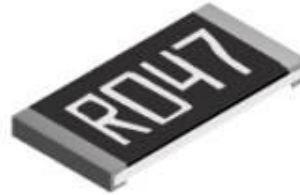

### Applications

- Power Management Applications
- Switching Power Supply
- Over Current Protection in Audio Application
- Voltage Regulation Module (VRM)
- DC-DC Converter, Battery Pack, Charger, Adaptor
- Automotive Engine Control
- Disk Driver
- Portable Devices (PDA, Cell Phone)

### Construction

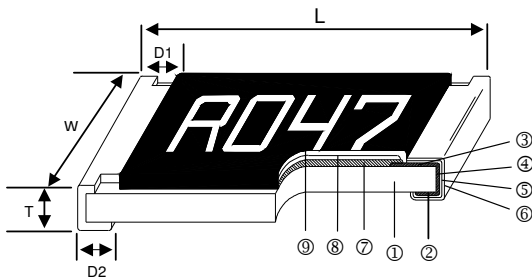

① Alumina Substrate	④ Edge Electrode (NiCr)	⑦ Resistor Layer (RuO <sub>2</sub> /Ag)
② Bottom Electrode (Ag-Pd)	⑤ Barrier Layer (Ni)	⑧ Primary Overcoat (Glass)
③ Top Electrode (Ag)	⑥ External Electrode (Sn)	⑨ Secondary Overcoat (Epoxy)

### Dimensions

Unit: mm

Type	Size (Inch)	L	W	T	D1	D2	Weight (g) (1000pcs)
RS-02	0402	1.00±0.05	0.50±0.05	0.35±0.05	0.20±0.10	0.20±0.10	0.620
RS-03	0603	1.60±0.10	0.80±0.10	0.45±0.10	0.30±0.20	0.30±0.20	2.042
RS-05	0805	2.00±0.10	1.25±0.10	0.50±0.10	0.35±0.20	0.40±0.20	4.368
RS-06	1206	3.10±0.10	1.55±0.10	0.55±0.10	0.50±0.25	0.50±0.20	8.947
RS-10	1210	3.20±0.20	2.60±0.15	0.55±0.10	0.50±0.25	0.50±0.20	15.959
RS-0A	2010	5.00±0.20	2.50±0.15	0.55±0.10	0.60±0.25	0.50±0.20	24.241
RS-12	2512	6.35±0.20	3.20±0.15	0.55±0.10	0.60±0.25	0.50±0.20	39.448

## Part Numbering

RS-	03	F	L	7	-0R047
Product Type	Dimensions (L×W)	Resistance Tolerance	Function Code	Packaging Code	Resistance
	02: 0402 03: 0603 05: 0805 06: 1206 10: 1210 0A: 2010 12: 2512	F: ±1% J: ±5%	L: Standard P: High Power	4: 7" Reel 4Kpcs 6: 7" Reel 10Kpcs 7: 7" Reel 5Kpcs 9: 10" Reel 8Kpcs A: 10" Reel 10Kpcs B: 10" Reel 20Kpcs C: 13" Reel 40Kpcs D: 13" Reel 20Kpcs F: Bulk	- 0R047: 0.047Ω - - - 0R1: 0.1Ω "- " to fill up 6 spaces

## Derating Curve

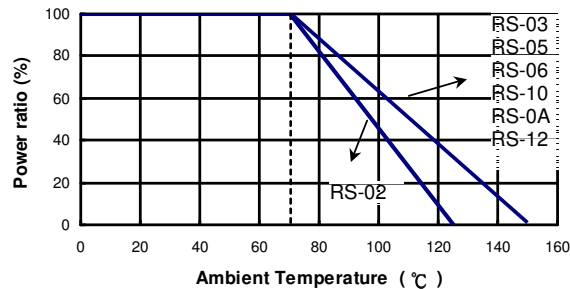

## Standard Electrical Specifications

Type	Item	Power Rating at 70°C	Operating Temp. Range	Resistance Range (mΩ)		TCR (PPM/°C)
				±1%	±5%	
RS-02 (0402)		1/16W	-55~+125°C	50 - 99 100 - 499 500 - 976	±800 ±500 ±200	
RS-03 (0603)		1/10W	-55~+155°C	20 - 47 50 - 99 100 - 499 500 - 976	±1200 ±800 ±500 ±200	
RS-05 (0805)		1/8W	-55~+155°C	10 - 18 20 - 47	±1500 ±1200	
RS-06 (1206)		1/4W		50 - 99 100 - 499 500 - 976	±800 ±500 ±200	
RS-10 (1210)		1/3W	-55~+155°C	10 - 18 20 - 47	±1500 ±800	
RS-0A (2010)		3/4W		50 - 99	±800	
RS-12 (2512)		1W		100 - 499 500 - 976	±200 ±200	

Operating Voltage= $\sqrt{P \cdot R}$

Overload Voltage= $2.5 \cdot \sqrt{P \cdot R}$

## High Power Rating Electrical Specifications

Type	Item	Power Rating at 70°C	Operating Temp. Range	Resistance Range (mΩ)		TCR (PPM/°C)
				±1%	±5%	
RS-02 (0402)		1/10W	-55~+125°C	50 - 99	100 - 499	±800
				500 - 976		±500
						±200
RS-03 (0603)		1/8W	-55~+155°C	20 - 47	50 - 99	±1200
				100 - 499		±800
				500 - 976		±500
RS-05 (0805)		1/4W	-55~+155°C	10 - 18	20 - 47	±1500
RS-06 (1206)		1/3W		50 - 99		±1200
				100 - 499		±800
RS-10 (1210)		1/2W	-55~+155°C	500 - 976		±500
RS-0A (2010)		1W		10 - 18		±200
				20 - 47		±1500
RS-12 (2512)		2W		50 - 99		±800
				100 - 499		±200
				500 - 976		±200

Operating Voltage= $\sqrt{P \cdot R}$

Overload Voltage= $2.5 \cdot \sqrt{P \cdot R}$

## Soldering Condition

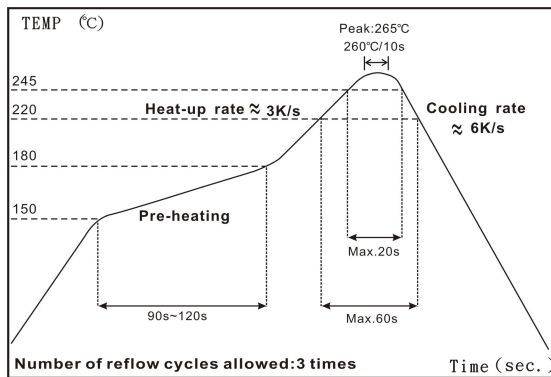

IR Reflow Soldering

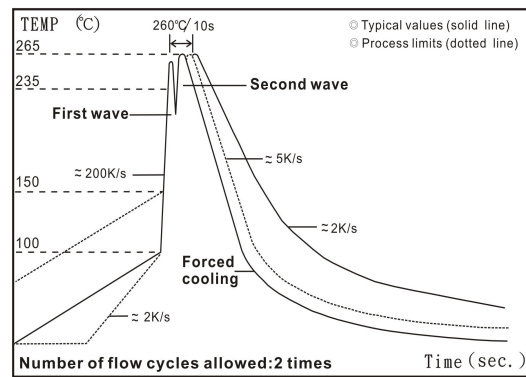

Wave Soldering (Flow Soldering)

- (1) Time of IR reflow soldering at maximum temperature point 260°C : 10s
- (2) Time of wave soldering at maximum temperature point 260°C : 10s
- (3) Time of soldering iron at maximum temperature point 410°C : 5s

## ■ Environmental Characteristics

Item	Requirement		Test Method
	1%	5%	
Temperature Coefficient of Resistance (T.C.R.)	As Spec.		<b>JIS C 5201-1 4.8</b> <b>IEC 60115-1 4.8</b> -55°C~+125/+155°C, 25°C is the reference temperature
Short Time Overload	±(1.0%+0.05Ω)	±(2.0%+0.05Ω)	<b>JIS C 5201-1 4.13</b> <b>IEC 60115-1 4.13</b> 2.5 times RCWV or Max. overload voltage for 5 seconds, 2 seconds for high power series
Insulation Resistance	≥ 10G		<b>JIS C 5201-1 4.6</b> <b>IEC 60115-1 4.6</b> Max. overload voltage for 1 minute
Endurance	±(2.0%+0.10Ω)	±(3.0%+0.10Ω)	<b>JIS C 5201-1 4.25</b> <b>IEC 60115-1 4.25.1</b> 70±2°C, Max. working voltage for 1000 hrs with 1.5 hrs "ON" and 0.5 hrs "OFF"
Damp Heat with Load	±(2.0%+0.10Ω)	±(3.0%+0.10Ω)	<b>JIS C 5201-1 4.24</b> 40±2°C, 90~95% R.H., Max. working voltage for 1000 hrs with 1.5 hrs "ON" and 0.5 hrs "OFF"
Dry Heat	±(1.0%+0.05Ω)	±(1.5%+0.10Ω)	<b>JIS C 5201-1 4.23.2</b> <b>IEC 60115-1 2.23.2</b> at +125/+155°C for 1000 hrs
Bending Strength	±(1.0%+0.05Ω)	±(1.0%+0.05Ω)	<b>JIS C 5201-1 4.33</b> <b>IEC 60115-1 4.33</b> Bending once for 5 seconds with 3mm 2010, 2512 sizes: 2 mm
Solderability	>95% coverage		<b>JIS C 5201-1 4.17</b> <b>IEC 60115-1 4.17</b> 245±5°C for 3 seconds
Resistance to Soldering Heat	±(0.5%+0.05Ω)	±(1.0%+0.05Ω)	<b>JIS C 5201-1 4.18</b> <b>IEC 60115-1 4.18</b> 260±5°C for 10 seconds
Voltage Proof	No breakdown or flashover		<b>JIS C 5201-1 4.7</b> <b>IEC 60115-1 4.7</b> 1.42 times RCWV (RMS) for 1 minute
Leaching	Individual leaching area ≤5% Total leaching area ≤10%		<b>JIS C 5201-1 4.18</b> <b>IEC 60068-2-58 8.2.1</b> 260±5°C for 30 seconds
Rapid Change of Temperature	±(0.5%+0.05Ω)	±(1.0%+0.05Ω)	<b>JIS C 5201-1 4.19</b> <b>IEC 60115-1 4.19</b> -55°C to +125/+155°C, 5 cycles

■ Storage Temperature: 25±3°C; Humidity < 80%RH

## ■ Packaging

Reel Specifications & Packaging Quantity

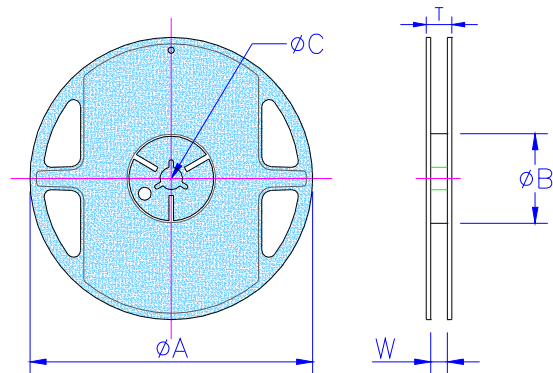

Unit: mm

Type	Packaging Quantity	Tape width	Reel Diameter	$\Phi A$	$\Phi B$	$\Phi C$	W	T	
RS-02	Paper	10K	8mm	7 inch	178.5±1.5	60 <sup>+1/-0</sup>	13.0±0.2	9.0±0.5	12.5±0.5
		20K		10 inch	254±1	100±0.5	13.0±0.2	9.5±0.5	13.5±0.5
40K									
RS-03	Paper	5K	8mm	13 inch	330±1	100±0.5	13.0±0.2	9.5±0.5	13.5±0.5
RS-05		10K							
RS-06		20K		13 inch	330±1	100±0.5	13.0±0.2	9.5±0.5	13.5±0.5
RS-10									
RS-0A		Embossed		4K	12mm	7 inch	178.5±1.5	60 <sup>+1/-0</sup>	13.0±0.5
RS-12	8K		10 inch	250±1		62±0.5	13.0±0.5	12.5±0.5	16.5±0.5

## Paper Tape Specifications

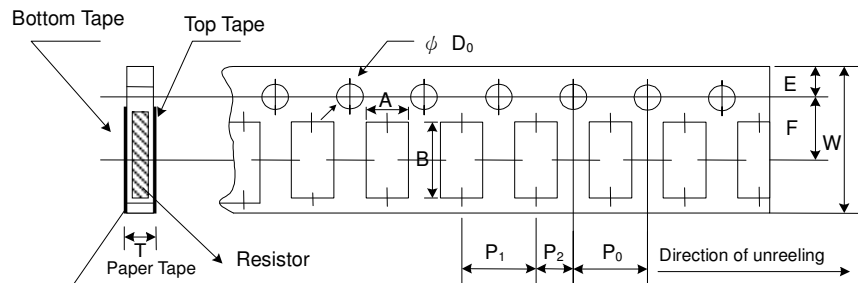

Unit: mm

Type	A	B	W	E	F	$P_0$	$P_1$	$P_2$	$\Phi D_0$	T
RS-02	0.65±0.10	1.15±0.1	8.0±0.2	1.75±0.1	3.50±0.05	4.00±0.10	2.00±0.05	2.00±0.05	1.50+0.1,-0	0.45±0.1
RS-03	1.10±0.10	1.90±0.1	8.0±0.2	1.75±0.1	3.50±0.05	4.00±0.10	4.00±0.05	2.00±0.05	1.50+0.1,-0	0.70±0.1
RS-05	1.60±0.10	2.40±0.2	8.0±0.2	1.75±0.1	3.50±0.05	4.00±0.10	4.00±0.05	2.00±0.05	1.50+0.1,-0	0.85±0.1
RS-06	1.90±0.10	3.50±0.2	8.0±0.2	1.75±0.1	3.50±0.05	4.00±0.10	4.00±0.05	2.00±0.05	1.50+0.1,-0	0.85±0.1
RS-10	2.80±0.10	3.50±0.2	8.0±0.2	1.75±0.1	3.50±0.05	4.00±0.10	4.00±0.05	2.00±0.05	1.50+0.1,-0	0.85±0.1

Embossed Plastic Tape Specifications

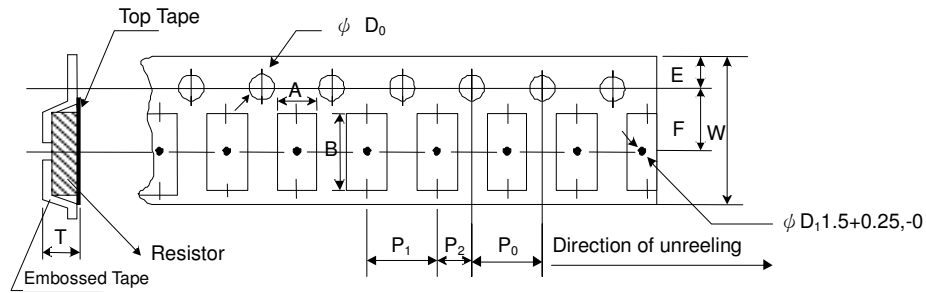

Unit: mm

Type	A	B	W	E	F	P <sub>0</sub>	P <sub>1</sub>	P <sub>2</sub>	ΦD <sub>0</sub>	T
RS-0A	2.8±0.20	5.5±0.20	12.0±0.3	1.75±0.1	5.5±0.05	4.00±0.10	4.00±0.1	2.00±0.05	1.50+0.1, -0	1.2 <sup>+0</sup>
RS-12	3.5±0.20	6.7±0.20	12.0±0.3	1.75±0.1	5.5±0.05	4.00±0.10	4.00±0.1	2.00±0.05	1.50+0.1, -0	1.2 <sup>+0</sup>

■ Marking

No marking for 0402

1%, 5% for 0805/1206/1210/2010/2512: 4 digits marking

Example:

Resistance	47mΩ	75mΩ	15mΩ	750mΩ	820 mΩ
Marking	R047	R075	R015	R750	R820

1%, 5% for 0603: 3 digits marking in E24

1% for 0603: 3 digits marking & under-line in E96 (non-including E24 series)



3 digits marking for E24 & R value suffix is zero in E96: R10=100mΩ R28=280mΩ

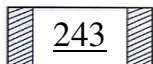

3 digits marking for E96: 243=243mΩ 511=511mΩ

E24 code	10	11	12	13	15	16	18	20	22	24	27	30	33	36	39	43	47	51	56	62	68	75	82	91
----------	----	----	----	----	----	----	----	----	----	----	----	----	----	----	----	----	----	----	----	----	----	----	----	----

■ Recommend Land Pattern

Unit: mm

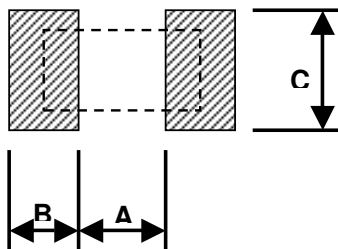

Type	A	B	C
RS-02	0.50	0.45	0.60
RS-03	0.90	0.60	0.90
RS-05	1.20	0.70	1.30
RS-06	2.00	0.90	1.60
RS-10	2.00	0.90	2.80
RS-0A	3.80	0.90	2.80
RS-12	3.80	1.60	3.50